

Buying guide

# Beds



## A good day always starts with a good night

Feeling your best when you wake up starts with the right bed. In this buying guide, you will find all our beds, including bed frames with and without storage, day beds, loft beds, bunk beds and upholstered beds. You will also get an overview of our bed accessories, such as headboards and bed storage boxes.

Of course, a bed is not complete without a mattress and bedding. You can test and find the best mattress for you in the mattress studio. The textiles department has a wide range of comforters, pillows and bed linen.

A high standard of accuracy has been sought in the preparation of this buying guide. We apologize for, but will not be bound by or responsible for, errors and omissions in this buying guide.

Not all products may be available in all stores. See what is available at your local store by visiting [IKEA-USA.com](http://IKEA-USA.com). For more detailed product information, see the price tag or visit [IKEA-USA.com](http://IKEA-USA.com). All products shown require assembly. All textiles shown are imported.



# How to buy a complete bed

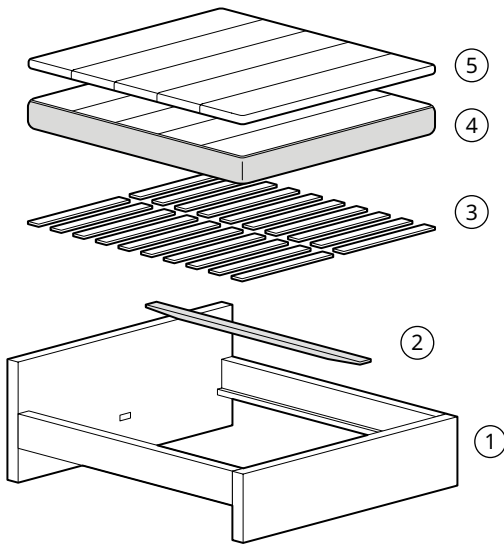

## A complete bed frame with mattress consists of these parts:

1. Choose a bed frame and size.
2. SKORVA midbeam (art nr 901.245.34) is needed for most full, queen and king beds. It is picked up separately in the self-serve furniture area. For upholstered bed frames, the midbeam is included in the packaging.
3. For most bed frames, you will also need to choose a slatted bed base, see more on page 8. For some upholstered bedframes, the slatted bed base is included in the price and packaging.
4. Choose a mattress or use the one you have at home. You can find the best one for you in the mattress studio.
5. Add a mattress pad of your choice for a softer sleeping surface.

## Bed configurator

Design the bed of your dreams (so easy, you can do it). Start planning today at: [IKEA-USA.com/planner](http://IKEA-USA.com/planner)

## Bed frames



**BJÖRKSJÄ Bed frame** SKORVA midbeam and slatted bed base required, but sold and packaged separately. See page 6

Queen	005.612.32
King	605.612.29



**GRIMSBU Bed frame**, metal. Midbeam included. Slatted bed base, sold and packaged separately. See page 6.

White metal	
Twin	005.085.17
Full	805.085.18
Queen	905.085.13
Gray metal	
Twin	205.085.16
Full	705.085.14
Queen	405.085.15



**GURSKEN Bed frame**, light beige. Midbeam included. Slatted bed base is required, but sold and packaged separately. See page 6.

Full	105.032.89
------	------------

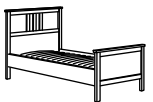

**HEMNES Bed frame**, pine. Slatted bed base is required for all sizes, but sold and packaged separately. See page 6. For full, queen and king beds, SKORVA midbeam is required but sold and packaged separately.

White stained	
Twin	402.495.60
Full	802.421.04
Queen	902.421.13
King	102.421.07
Gray stained	
Twin	603.817.56
Full	203.817.39
Queen	903.817.45
King	103.817.54
Black brown	
Twin	302.495.51
Full	202.421.02
Queen	702.421.09
King	502.421.05



**IDANÄS Bed frame** Midbeam included. Slatted bed base is required, but sold and packaged separately. See page 6.

White	
Twin	504.596.61
Full	104.589.08
Queen	304.589.12
King	704.589.10



Dark brown stained	
Twin	704.596.60
Full	304.589.07
Queen	504.589.11
King	904.589.09



**MALM Bed frame** Slatted bed base is required for all sizes, but sold and packaged separately. See page 6. For full, queen and king beds, SKORVA midbeam is required but sold and packaged separately.

White	
Twin	402.494.90
Full	902.494.78
Queen	902.494.83
King	502.494.80



Black brown veneer	
Twin	102.494.96
Full	102.494.77
Queen	702.494.84
King	702.494.79

Gray stained	
Twin	504.586.09
Full	304.586.29
Queen	104.586.30
King	904.586.31

White stained oak veneer	
Twin	
Full	702.631.30
Queen	502.631.45
King	402.631.36

## Bed frames



**NEIDEN Bed frame**, pine. Midbeam included. Slatted bed base is required, but sold and packaged separately. See page 6.

Twin	003.952.52
Full	803.952.48



**SAGSTUA Bed frame**, metal. Slatted bed base is required for all sizes, but sold and packaged separately. See page 6. For full, queen and king beds, SKORVA midbeam is required but sold and packaged separately.

### White

Twin	992.791.97
Full	492.542.03
Queen	892.542.01
King	692.542.02



### Black

Twin	792.792.02
Full	592.688.98
Queen	792.689.01
King	392.688.99



**SONGESAND Bed frame** Slatted bed base is required for all sizes, but sold and packaged separately. See page 6. For full, queen and king beds, SKORVA midbeam is required but sold and packaged separately.

### White

Twin	903.725.62
Full	203.725.13
Queen	703.725.15



### Brown

Twin	103.725.61
Full	803.725.29
Queen	403.725.31



**TARVA Bed frame**, pine. Slatted bed base is required for all sizes, but sold and packaged separately. See page 6. For full, queen and king beds, SKORVA midbeam is required but sold and packaged separately.

Twin	702.612.68
Full	302.499.47
Queen	902.499.49
King	105.050.33



**VEVELSTAD Bed frame**, white. Slatted bed base and midbeam are included.

Twin	105.182.76
Full	005.064.34
Queen	505.064.36
King	405.202.54



**YTTERVÅG Bed frame** Slatted bed base and midbeam are included.

### Black/wood

Queen	004.931.44
King	704.931.45



### Gray-brown/wood

Queen	504.931.46
King	304.931.47

## Upholstered bed frames



**GLADSTAD Upholstered bed frame** Slatted bed base and midbeam included, but packaged and sold separately.

### Kabusa light gray, fixed cover

Twin	404.904.71
Full	104.904.61
Queen	004.904.66



### HAUGA Upholstered frame

Slatted bed base and midbeam are included, but packaged and sold separately.

### Vissle gray, polyester, fixed cover

Twin	404.500.91
Full	404.463.63
Queen	904.463.65



### Lofallet beige, polyester, fixed cover

Twin	304.904.84
Full	304.904.79
Queen	504.904.83



**KLEPPSTAD Bed frame**, white/Vissle beige. Slatted bed base and midbeam are included, but packaged and sold separately.

Full	404.926.80
Queen	004.926.82



**IDANÅS Upholstered bed frame** Slatted bed base and midbeam are included.

### Gunnared pale pink, polyester, fixed cover

Twin	
Full	504.846.94
Queen	404.589.59
King	804.589.57



### Gunnared dark gray, polyester, fixed cover

Twin	
Full	704.846.93
Queen	604.589.58
King	004.589.56



**SAGESUND Upholstered bed frame** Midbeam included. Slatted bed base is required for all sizes, but sold and packaged separately. See page 6.

### Diseröd brown

Full	604.903.88
Queen	604.903.93
King	004.903.91



**SLATTUM Upholstered bed frame** Slatted bed base and midbeam are included, but packaged and sold separately.

### Vissle dark gray, polyester, fixed cover

Twin	105.712.59
Full	405.712.53
Queen	705.712.56



### Knisa bright blue, polyester, fixed cover

Queen	105.712.78
-------	------------



### TUFJORD Upholstered bed frame

Midbeam included. Slatted bed base is required for all sizes, but sold and packaged separately. See page 6.

### Tallmyra black-blue, cotton/polyester, fixed cover

Full	905.725.04
Queen	205.725.07
King	605.725.05

### Gunnared blue, polyester, fixed cover

Full	505.732.56
Queen	105.732.58
King	305.732.57

## Upholstered bed frames



**TÄLLÅSEN Upholstered bed frame** Midbeam included. Slatted bed base is required for all sizes, but sold and packaged separately. See page 6.

**Gray green**

Full	105.389.34
Queen	405.389.37
King	305.504.25

**Light beige**

Full	105.727.96
Queen	705.727.98
King	905.727.97



**VADHEIM Upholstered bed frame** Slatted bed base and midbeam are included.

**Gunnared light green, polyester, fixed cover**

Full	004.771.44
Queen	304.656.82
King	804.656.89

## Upholstered bed frames with storage



**GLADSTAD Upholstered bed frame with two storage boxes** Slatted bed base and midbeam included but sold and packaged separately.

**Kabusa light gray, polyester, fixed cover**

Twin	494.067.63
Full	594.068.14
Queen	894.068.03



**GLADSTAD Upholstered bed frame with four storage boxes** Slatted bed base and midbeam included.

**Kabusa light gray, polyester, fixed cover**

Full	004.904.71
Queen	104.904.61
King	004.904.66



**HAUGA Upholstered bed frame with two storage boxes.** Slatted bed base and midbeam included.

**Vissle gray, polyester, fixed cover**

Twin	093.366.11
Full	393.366.57
Queen	793.366.60



**HAUGA Upholstered bed frame with four storage boxes** Slatted bed base and midbeam included.

**Vissle gray, polyester, fixed cover**

Full	693.366.08
Queen	793.366.03



**IDANÅS Upholstered storage bed** Slatted bed base and midbeam included, but packaged and sold separately.

**Gunnared dark gray, polyester, fixed cover**

Full	204.846.95
Queen	004.471.90
King	404.471.88

**Gunnared pink, polyester, fixed cover**

Full	004.846.96
Queen	204.471.89
King	505.141.44

## Storage bed frames



**BRIMNES Bed frame with storage**, four drawers. Slatted bed base and midbeam are sold and packaged separately.

**White**

Full	702.287.21
Queen	302.287.23
King	902.501.17

**Black**

Full	602.737.85
Queen	902.737.84
King	102.737.83

**Gray**

Full	504.702.39
Queen	204.702.50
King	704.702.43



**BRIMNES Bed frame with storage and headboard**, four drawers. Midbeam included but sold and packaged separately. Slatted bed base is required for all sizes, but sold and packaged separately. See page 6.

**White**

Full	990.991.96
Queen	490.992.50
King	390.992.41

**Black**

Full	190.991.95
Queen	190.992.42
King	590.992.40

**Gray**

Full	293.248.53
Queen	593.248.61
King	393.248.57



**IDANÅS Bed frame with storage** Midbeam included, but sold and packaged separately. Slatted bed base is required for all sizes, but sold and packaged separately. See page 6.

**White**

Twin	104.596.77
Full	204.588.80
Queen	404.588.84
King	804.588.82

**Dark brown stained**

Twin	304.596.76
Full	404.588.79
Queen	604.588.83
King	004.588.81

# Storage beds



**MALM Bed frame with two storage boxes**  
Midbeam included but sold and packaged separately. Slatted bed base is required for all sizes, but sold and packaged separately. See page 6.

**White**

Twin	490.129.97
Full	391.759.61
Queen	991.759.63
King	191.759.62

**Black brown veneer**

Twin	690.129.96
Full	691.762.66
Queen	291.762.68
King	491.762.67

**White stained oak veneer**

Full	891.764.73
Queen	591.764.79
King	091.764.72

**Gray**

Twin	193.116.10
Full	493.115.81
Queen	793.115.89
King	593.115.85



**MALM bed frame with four storage boxes**  
Midbeam included but sold and packaged separately. Slatted bed base is required for all sizes, but sold and packaged separately. See page 6.

**White**

Full	899.316.16
Queen	499.316.18
King	699.316.17

**Black brown veneer**

Full	599.316.32
Queen	199.316.34
King	399.316.33

**White stained oak veneer**

Full	190.226.86
Queen	490.094.57
King	090.226.82

**Gray**

Full	493.115.95
Queen	693.116.03
King	693.115.99



**MALM ottoman bed.** Slatted bed base is included, and SKORVA midbeam is not needed for this bed.

For the open and soft-close mechanism to work safely and properly, combine with a mattress within the maximum weight limit: Full - 88 lbs, Queen - 110 lbs.

**White**

Full	104.048.16
Queen	704.048.18

**Black brown veneer**

Full	304.048.15
Queen	904.048.17



**NORDLI Bed frame with storage** Slatted bed base is included, and SKORVA midbeam is not needed for this bed.

**White**

Queen	003.498.49
King	303.498.57

**Anthracite**

Queen	503.727.81
King	003.727.88



**NORDLI Bed frame with storage and headboard** Slatted bed base is included, and SKORVA midbeam is not needed for this bed.

**White**

Queen	692.414.22
King	392.414.28

**Anthracite**

Queen	392.414.09
King	792.414.12



**SONGESAND Bed frame with two storage boxes** Slatted bed base and midbeam included but sold and packaged separately.

**White**

Twin	092.410.19
Full	292.412.16
Queen	692.412.19

**Brown**

Twin	992.409.87
Full	192.411.32
Queen	692.411.39



**SONGESAND Bed frame with four storage boxes** Slatted bed base and midbeam included but sold and packaged separately.

**White**

Full	392.413.29
Queen	792.413.32

**Brown**

Full	792.411.86
Queen	392.411.93

# Slatted bed bases

Combined with a bed frame, slatted bed-bases can be used as a base for spring, foam and latex mattresses. They help your mattress last longer and stay comfortable by absorbing most of the stress and weight placed on your bed.

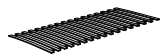

**LURÖY Slatted bed base** Extend the life of your mattress and get extra support with 17 wooden slats in the bed base.

Twin	601.602.17
Full	302.927.85
Queen	001.602.15
King	501.602.13



**LÖNSET Slatted bed base, fixed** 28 birch slats adjust to your body weight and increase the suppleness of the mattress. Comfort zones adjust to your body.

Twin	302.787.32
Full	602.787.16
Queen	802.787.15
King	302.787.13

## Accessories

### Headboards Width×Height×Thickness

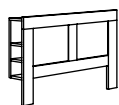

**BRIMNES Headboard** For use with BRIMNES bedframes.

#### White

Full	202.287.14
Queen	702.287.16
King	702.501.18

#### Black

Full	302.691.72
Queen	902.691.69
King	102.691.68

#### Gray

Full	704.702.62
Queen	304.702.64
King	504.702.63



**NORDLI Headboard** Must be mounted to the wall. Each headboard includes two shelves (12×10½×4") and two boxes (9½×4×4").

#### White

Queen	103.729.76
King	903.727.60

#### Anthracite

Queen	903.729.77
King	803.727.94



**MALM Bed storage boxes, 2pk**

#### White

Twin/Full	002.527.19
Queen/King	202.527.23

#### Black brown

Twin/Full	202.527.18
Queen/King	602.527.21

#### White stained oak veneer

Twin/Full	802.646.81
Queen/King	102.646.94

#### Gray

Twin/Full	104.586.49
Queen/King	604.586.56



**SONGESAND Bed storage boxes, set of 2.**

#### White

Twin/Full	103.725.42
Queen/King	703.725.44

#### Brown

Twin/Full	303.725.41
Queen/King	903.725.43



**VARDÖ Bed storage box, W25½×D27½×H7½".**

Black	202.382.23
-------	------------

### Bed storage boxes



**FREDVANG Underbed/bedside table storage, 23¼×22".**

White	104.936.38
-------	------------



**GLADSTAD Upholstered bed storage boxes, 2pk**

#### Kabusa light gray

Twin/full	604.984.26
Queen/King	404.984.27



**HAUGA Upholstered bed storage boxes, 2pk**

#### Vissle gray

Twin/Full	604.742.08
Queen/King	404.742.09

#### Lofallet beige

Twin/Full	704.741.99
Queen/King	304.742.00



**HEMNES Underbed storage boxes, 2pk**

#### White

Twin/Full	903.262.97
Queen/King	403.262.90

#### Black-brown

Twin/Full	103.262.96
Queen/King	803.262.88

#### Gray

### Legs



**BRENNÅSEN Legs, 4pk**

#### Black

H3½"	202.996.88
H7½"	002.996.89



**BURFJORD Legs, 4pk**

#### Oak

H7½"	20299693
------	----------

# Day beds

## Daybed frames

Daybeds extend to make two twin sized beds. We recommend using two twin ÅGOTNES or ÅSVANG foam mattresses or two twin VANNAREID spring mattresses. Slatted bed base is included and SKORVA midbeam is not needed for daybeds.



**BRIMNES Daybed frame with two drawers**

<b>White</b>	
Twin	402.287.08
<b>Gray</b>	
Twin	305.146.49



**FLEKKE Daybed frame**

<b>Black brown</b>	
Twin	204.901.49

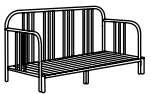

**FYRESDAL Daybed frame, black.**

Twin	304.243.66
------	------------

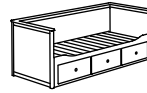

**HEMNES Daybed frame, white.**

<b>White</b>	
Twin	303.493.29
<b>Gray</b>	
Twin	204.727.01

<b>Black-brown</b>	
Twin	604.214.46



**UTÅKER Stackable beds, pine.**

Twin (set of 2)	303.604.87
-----------------	------------

# Bunk beds and loft beds

Suitable for children from 6 years of age

Bunk beds have sleeping for two – an upper bunk and a lower bunk. Loft beds provide sleeping for one, with space underneath for storage, play or study. Both are single beds. Only children over age 6 should sleep in the top bunk. The top bed has a solid guardrail at a good height for the safety of the top sleeper. Minimal gaps in the rail ensure that the child cannot fall out. But the guardrail loses its function if the

mattress is too high up in the bed to make the guardrail protective. So use a mattress that is the right thickness for a loft bed or top bunk.

Complete the loft bed with a mattress in a matching size and the bunk bed with two twin mattresses. Slatted bed base is included and SKORVA midbeam is not needed for loft and bunk beds.

## Loft beds



**SMÅSTAD Loft bed frame with desk and storage** With this loft bed you get a complete solution for your child's room – including desk, wardrobe and open shelf unit. Maximum mattress thickness: 8½". Minimum ceiling height required: 94½". White

Twin	504.540.41
------	------------



**STORÅ Loft bed frame** The ladder mounts on the right or the left side of the bed. Maximum mattress thickness: 8½". Minimum ceiling height required: 106". Black stained pine

Black stained pine	801.608.67
--------------------	------------



**VITVAL Loft bed frame** It is the details that make this loft bed unique. Soft shapes, sturdy ladder and fabric guardrails with yellow accents. You can also dress it with bedlinens and accessories from the MÖJLIGHET series. Maximum mattress thickness: 5½". White/light gray

Twin	704.112.39
------	------------



**VITVAL Desk top** With this desk, you can easily create a writing space under VITVAL loft bed. The support leg makes it sturdy and you can pimp the pegboard with accessories from the SKÅDIS series. The holes fit perfectly. W40½×D17¾×H28¾".

White	204.114.11
-------	------------

## Bunk beds

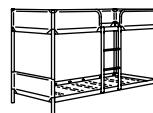

**TUFFING Twin bunk bed** A good solution where space is limited. The bed is lower, which makes it easier to make the bed. Bed base included. Ladder mounts to left or right side. Maximum mattress thickness: 5½".

Gray	702.992.85
------	------------

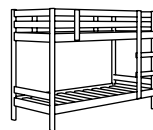

**MYDAL Twin bunk bed frame** The ladder mounts on the right or the left side of the bed. Made of solid wood, which is a hardwearing and warm natural material. A good solution where space is limited. Slatted bed base is included. Maximum mattress thickness: 8¾". Pine

Twin	201.024.51
------	------------



**VITVAL Twin bunk bed frame** Soft shapes and fabric guardrails. These are the details that make this bunk bed unique. Perfect when you need space for two, but have limited space. Maximum mattress thickness: 5½".

White/light gray	704.112.77
------------------	------------

Remember! Never allow a child under 6 years old on the upper bunk.

# SERVICES

IKEA products are designed to be taken home and assembled by you. That way, you'll save the most money. But if you would like some help, we can offer a range of services. Assembly and delivery services fulfilled by an Independent Service Provider. Contact your local IKEA store or visit the IKEA website for details: [IKEA-USA.com/services](https://www.IKEA-USA.com/services)

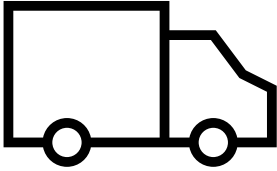

## DELIVERY SERVICE

Most of our products are designed and packaged so that you can take them home yourself. If you prefer, we can arrange for delivery of your purchases directly to your home or business. Same day, next day or same week deliveries are available. We can also arrange for delivery at a later date if you would like.

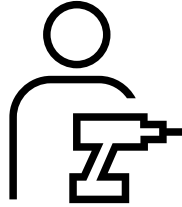

## TASKRABBIT ASSEMBLY SERVICE

All IKEA products are designed to be assembled by you, but you don't have to. We've partnered with TaskRabbit to connect you with a network of independent 'Taskers' who can provide quick and convenient assembly and mounting services for your IKEA purchases made online and in stores. You can schedule assembly service for as soon as the same day, with the Tasker of your choice. Visit [TaskRabbit.com/IKEA](https://www.TaskRabbit.com/IKEA) or see a co-worker for more details.

Services and prices may vary, please see [IKEA-USA.com/services](https://www.IKEA-USA.com/services) or talk to us in your local IKEA store.



## IKEA Projekt Credit Card

Your dream home is now within reach and more affordable than ever. With the IKEA Projekt Credit Card\*, you don't have to put off loving every room in your home.

\*Credit card offers are subject to approval.

IKEA Projekt Credit Card Accounts are issued by Comenity Capital Bank.

To learn more visit [IKEA-USA.com/creditcard](https://www.IKEA-USA.com/creditcard) or drop by your local IKEA store.