

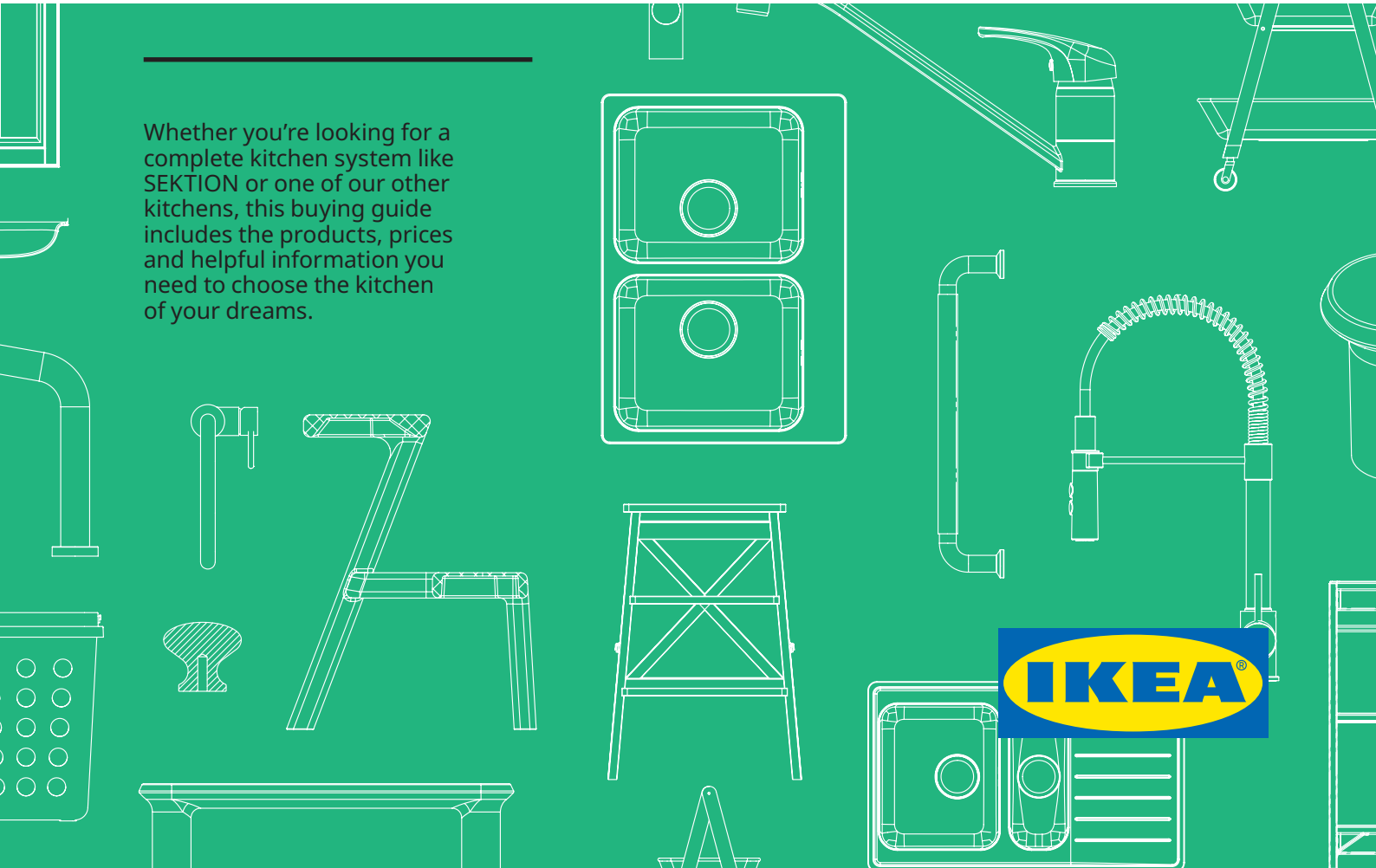

*A guide to
buying an
IKEA kitchen*

IKEA KITCHENS

Whether you're looking for a complete kitchen system like SEKTION or one of our other kitchens, this buying guide includes the products, prices and helpful information you need to choose the kitchen of your dreams.





Sinks and faucets.
See pages 72-84



Working in your kitchen is safer, easier and a lot more enjoyable with good lighting on the countertop, behind glass doors and in drawers. See page 52



You can do everything yourself, but you don't have to. With our broad service offer we can assist you with everything from measuring and planning to complete kitchen installation. See page 6



Table of contents

Steps to buying an IKEA kitchen	4	KNOXHULT kitchen	86
Services	6	ÖNNERUP kitchenette	90
More information and guidance	7	ÄSPINGE kitchenette	92
IKEA Kitchens	8	SUNNERSTA kitchenette	94
SEKTION kitchen system	10	Kitchen islands, carts, stools and accessories.....	96
Doors and drawer fronts.....	12	Knobs and handles.....	108
Cover panels, decorative moldings, toekicks and legs.....	24	Limited warranties	112
SEKTION cabinets.....	36		
SEKTION interior fittings and organizers.....	46		
Lighting and sound.....	52		
Countertops.....	56		
Sinks.....	72		
Sink accessories.....	77, 101-107		
Kitchen faucets.....	78		



Looking for extra counter space and storage? An island can do both. The thick oak veneer countertop of TORNVIKEN kitchen island is a durable natural material that can be sanded and surface treated when required. Oak is an exceedingly strong and durable hardwood with a prominent grain. It darkens beautifully with age, acquiring a golden-brown undertone. 10-year limited warranty. See pages 122-123

Life in the kitchen goes a lot smoother when your drawers open up fully to help you reach everything. With interior fittings and organizers inside cabinets and drawers, finding what you're looking for will be easy-peasy. See page 46

Steps to buying an IKEA kitchen

IKEA kitchens are designed so that you can install them yourself. To the right are some steps to ensure the process goes well for you. Should you have any questions, don't hesitate to talk to our kitchen experts at your local IKEA store or visit us at: [IKEA.us](https://www.ikea.us)



Find your style

It's time to dream a little, look at some ideas, consider your needs and decide what an ideal kitchen means for you. This buying guide is made to give you an overview of some of the possibilities but there is so much more. You can find more ideas and inspiration on our website, in the kitchen brochure or by visiting your local IKEA store.



Measure

When measuring it's important to take your time and get your measurements correct. This will form the foundation of all your planning. To see exactly what to measure, take a look at the planning guide, *IKEA Kitchen Planning Guide*, at [IKEA.us/buyingguide](https://www.ikea.us/buyingguide)

→ **We can do it for you**
To learn more about our Measuring services see [page 6](#)



Plan

Planning your kitchen is when your dreams and ideas take shape. Use the online IKEA Home Planner tool to start planning your kitchen. We have trained coworkers who can review your design, answer your questions, and provide advice. Or, we can do it for you in the store or online.

→ **We can do it for you**
To learn more about our Kitchen planning services, view [page 6](#)

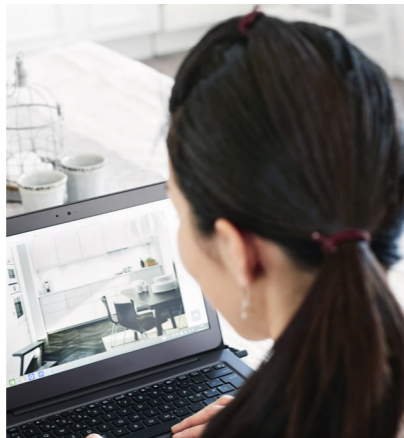

Order

When you're satisfied with your planning, visit your local IKEA store and talk to our kitchen experts. They will go over your kitchen plan with you, and help you with anything you're not sure about. When you are ready you can order and we can help with delivery.

→ **We can do it for you**
To learn more about our Delivery service, see [page 7](#)



Install

IKEA kitchens are designed to be installed by you, but we're here to offer as much help as you feel you need. You can start by picking up the kitchen installation guide from the store which gives step-by-step instructions on installing your kitchen.

→ **We can do it for you**
To learn more about our Kitchen installation service, view [page 7](#)

More tools and guidance

Buying guides



Appliances

This buying guide is filled with appliances developed to match perfectly with our kitchens. Inside, you'll find detailed information about styles and functions. Pick up a copy at your local IKEA store, or flip through them online at [IKEA.us/buyingguide](https://www.ikea.us/buyingguide)



SEKTION kitchen cabinets

This buying guide offers all you need to know to plan the inside of your cabinets and drawers in the most efficient way. [IKEA.us/buyingguide](https://www.ikea.us/buyingguide)

IKEA.us



IKEA.us/kitchens

On our webpage you'll find lots of inspiration and ideas to get the most out of your SEKTION, or KNOXHULT kitchen, whether it's a new one or an old that you want to freshen up. Plus, here you'll find all the products you can imagine to personalize and create the kitchen of your dreams.

Installation guides

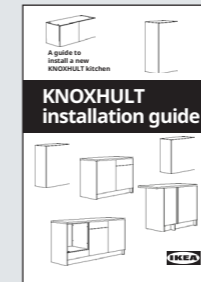

Our kitchen installation guides gives you tips and helpful information on how to install your new IKEA kitchen correctly. You'll find it at [IKEA.us/buyingguide](https://www.ikea.us/buyingguide)

Planning guide



Our kitchen planning guide is your guide to measuring, ordering and installing your new IKEA kitchen. Check it out at [IKEA.us/buyingguide](https://www.ikea.us/buyingguide)

Design and planning tools



The IKEA Kitchen planner

Design the SEKTION kitchen of your dreams in a 3D environment and get a price on every detail as well as the total kitchen. Print out your drawings and product list at home, or save to the IKEA website. At the IKEA store you can discuss your design and get lots of advice and guidance from our kitchen experts. Learn more at [IKEA.us/kitchenplanner](https://www.ikea.us/kitchenplanner)

KNOXHULT kitchen planner

Looking to create a practical kitchen with ease? The KNOXHULT kitchen planner is a simple design tool that can help you create a solution catered to your very needs. This tool allows you to select cabinets and combine them in a virtual environment, helping you visualize your kitchen setup. Once you select your preferred units, you can customize their arrangement to suit your needs, space, and preferences. Bring your KNOXHULT kitchen to life with just a few clicks. Discover more and get started at [IKEA.us/KNOXHULTplanner](https://www.ikea.us/KNOXHULTplanner)

Services

You can do it yourself, but you don't have to

Our service offer gives you the freedom to design your own price tag by choosing not only the products that suit your budget but also by deciding how much you want to do yourself and how much you want us to do for you. On this page you'll find the different services that are available to help and support you. For more details about our services, talk to a co-worker at your local IKEA store or visit us at [IKEA.us/kitchenservices](https://www.ikea.us/kitchenservices)



Kitchen Measurement Service

It's important to have your kitchen accurately measured before planning begins. An experienced IKEA Measurement Technician will come to your home, take all of the essential measurements, and enter the data in the IKEA Home Planner. Your Measurement Service fee is refunded when you have IKEA install your kitchen. Available for customers living within our service area.



IKEA Home Planner

You can plan your kitchen on your computer with our online 3D IKEA Home Planner at [IKEA.us/kitchenplanner](https://www.ikea.us/kitchenplanner). It's free, it's fun and it calculates your price as you click along. You can PRINT, SAVE and CHANGE your kitchen plan as many times as you want. Then come to the store and get advice — you can access the same plan you've been working on — and share it with our IKEA Kitchen Specialists.



Free Kitchen Planning Service

We offer two **no cost** options to have your kitchen professionally planned. You will receive a detailed layout of your kitchen including cabinets, appliances, and countertops, and a parts list to make it easy to order.

Most Convenient & available to everyone in the continental US:

Planning from Your Home Make a 90-minute appointment, online or in your local IKEA store. Allow time for you to measure your kitchen and select products before your appointment. A professional IKEA Kitchen Planner will work with you interactively online to plan your dream kitchen. You will be able to discuss every detail and view your plan being created. Your planner will follow-up with a second session to make any changes.

Visit an IKEA store:

Planning from the Store You can make an appointment online or at your local IKEA store for a two-hour in-store appointment with one of our professional IKEA Kitchen Planners. Allow time for measuring your kitchen and selecting products before your planning appointment.

Prior to your appointment, you will need to:

- **Measure your space** – The first step is getting your kitchen measurements. Instructions will be provided if you want to do this yourself. But if you live in an IKEA service area, a professional IKEA measurement technician can visit your home to measure your kitchen for you.
- **Choose your products** – Start browsing our kitchen products now to get a better understanding of what you want. You must know this before your planning session to make it productive.



In-Home Planning Service

Dreaming of a new kitchen but don't have the time to plan yourself? Our new in-home planning service has you covered! IKEA kitchen experts will come to your home, measure and assess your space and handle all the planning. The initial appointment may last up to four hours and requires a follow-up session (in-store or online) to finalize your design and complete your purchase. Best of all, the \$199 fee is applied toward your qualifying Kitchen Installation service.



IKEA Kitchen Installation Service

Professional IKEA kitchen installation makes your dream kitchen come true. Installation services are available in most areas. Check with your local store or the Kitchen Installation Services page on [IKEA.com](https://www.ikea.com) to see if installation is available in your area.

Kitchen installation includes:

- Assembly of cabinets, drawers, doors, and interior fittings
- Installation of cabinets, toe-kicks, and cover panels
- Adjustments of doors and drawers for proper appearance
- Installation of knobs and handles

Your kitchen will be installed to the highest industry standards by qualified professional carpenters

- Fully background checked, and trained
- Over a decade of experience with IKEA Kitchens
- Customer-focused with the ability to change orders and provide solutions
- Courteous, efficient, clean, and organized

Services and prices may vary. For more information about our services, visit [IKEA.us/services](https://www.ikea.us/services) or your local IKEA store.

5

IKEA Installation Services Limited Warranty

IKEA offers an industry-leading 5-year limited warranty on labor in conjunction with the IKEA 25-year product limited warranty you'll receive when purchasing your new IKEA Kitchen.



Delivery

Whether you're shopping in the store or online, and no matter how big the purchase, we can help do the heavy lifting and arrange delivery, by an Independent Service Provider, to your home or business.



IKEA Projekt Credit Card

Your dream home is now within reach. With the special financing options on our IKEA Projekt credit card*, you don't have to put off loving every room in your home.

*Subject to credit approval. IKEA Projekt Credit Card Accounts are issued by Comenity Capital Bank. To learn more visit [IKEA.us/creditcard](https://www.ikea.us/creditcard) or drop by your local store.



What type of kitchen are you looking for?

Whether you're looking for a complete kitchen system like SEKTION that you can personalize any way you want, or a simpler kitchen that you can install in a day, we have what you're looking for. Here you have four different types of IKEA kitchens to suit different needs and wishes.



SEKTION kitchen system

Our SEKTION kitchen system includes cabinets in several different sizes to fit your room layout as well as your kitchen routines. The flexibility of the system offers endless choices, giving you the freedom to build a kitchen that's ideal for you and your space. We've also developed an extensive range of kitchen organizers and interior fittings allowing you to quickly see and reach even the things farthest back in the corner cabinets. In addition you have a vast choice in front expressions, countertops, lighting, sinks, faucets, knobs, handles and much more to personalize every inch of your kitchen. **See pages 10-85**

KNOXHULT kitchen

KNOXHULT kitchen cabinets make it easy to create a practical kitchen. The selection of cabinets in different shapes and sizes come with pre-coordinated fronts and countertops and offer smart storage that help you stay organized, so all you have to do is combine them to suit your needs, space and preferences. When you're happy with the result, personalize with your favorite sink, faucet, appliances, knobs or handles and lighting to create a kitchen that works for you. **See pages 96-99**



KITCHENETTES

Not all of us have a lot of space or money for a traditional kitchen - and sometimes, we are just looking for a practical solution that isn't so complicated. Our kitchenettes offer all the ingredients for this very important function in clever, compact designs. Simply add TILLREDA small space appliances to customize your culinary space according to your needs. It's all there, personal, functional, affordable and easy to install. And guess what? Its easy to take it with you when you move. Simple as that. **See pages 100-105**

SEKTION KITCHEN SYSTEM

Endless possibilities

The modular design of SEKTION kitchen system is easy to install and gives you endless possibilities when designing your kitchen. Whether you have a taste for the traditional, love the minimalism in modern style or land somewhere in between, you'll surely find something that fits you.

To become truly beautiful, the kitchen has to be functional and take care of all your kitchen needs, too. With SEKTION you have the freedom to get the look you

want on the outside and keep everything in perfect order on the inside. Start by deciding the style of your dream kitchen by choosing the doors and drawer fronts, lighting, countertop, sink, faucet, knobs, handles and accessories that you like.

25
Year Limited
Warranty
Included

IKEA SEKTION kitchen has a free 25-year limited warranty. Find out more on [page 122](#).

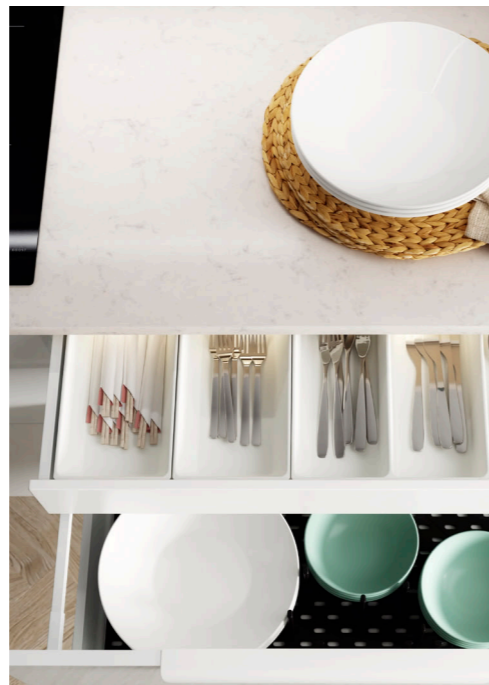

Doors and drawer fronts

Choose your style!

No matter what your personal style and preference is, make sure to choose a kitchen front you will love for years to come. It is the face of your kitchen, and most likely you will spend many hours in it.

We have a wide range of materials and finishes to choose from to suit your style — no matter what you like! Everything from traditional doors and drawer fronts that are rich in details, to high-gloss and modern doors and drawer fronts with integrated handles to give you that open clean look — we have it!

The process of choosing the style of your kitchen is all up to you, go for whatever you like — it is your kitchen! We have made sure that all our fronts are durable and of high quality. They all come with a free 25-year limited warranty to ensure that whatever you choose, it will last for years to come.

25
Year Limited
Warranty
Included

IKEA SEKTION kitchen has a free 25-year limited warranty. Find out more on [page 122](#).



Door and drawer front styles



Flat front doors and drawer fronts

Fat front doors offer you straight lines and smooth, easy to clean surfaces, simplicity in its truest form. Choose from a wide variety of finishes, colors and materials.



Frame doors and drawer fronts

Frame doors and drawer fronts are rich in detail, with a crafted look and feel—they create a kitchen with a rustic and traditional look. All our frame door families have a matching glass door.



High-gloss doors and drawer fronts

Glossy surfaces suit everyone from the minimalist to the wild family with kids. Stains are no problem as they are just as easy to wipe clean as they were to make.



Doors and drawer fronts with integrated handles

You might not notice them at first glance — and that's the idea! Integrated handles lend a minimalistic and modern feeling to your kitchen.

Sleek doors and drawer fronts



HAVSTORP

Color/design: Light gray
Material: Painted finish

HAVSTORP kitchen fronts in timeless light grey finish are defined by clean straight lines and smooth surface that create a neutral and harmonious expression that is easy to personalize.

Complement with HEJSTA white framed glass door and EKÖPING cover panels, decorative trim, and toe kicks as your finishing pieces.

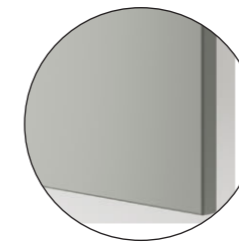

HAVSTORP

Color/design: Deep green
Material: Painted finish

HAVSTORP lacquered doors are smooth and seamless, resistant to moisture and staining and very easy to keep clean.

Complement with HEJSTA glass door.

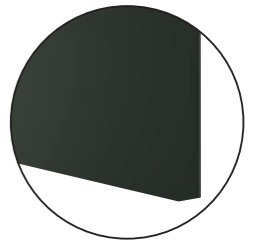

HAVSTORP

Color/design: Beige
Material: Painted finish

HAVSTORP lacquered doors are smooth and seamless, resistant to moisture and staining and very easy to keep clean.

Complement with HEJSTA glass door.

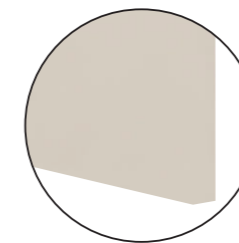

Sleek doors and drawer fronts



ASKERSUND
Color/design: Light ash wood effect
Material: Melamine foil finish

ASKERSUND is a blonde ash wood effect door, with a grain pattern that you can see and feel. It creates a light, modern kitchen. Complement with HEJSTA accent door.



TISTORP
Color/design: Brown walnut effect
Material: Foil finish

TISTORP door and drawer fronts offer a classic, modern walnut look with smooth surface and simple design. The wooden finish is easy on the eyes, yet makes an impression, adding instant warmth and style. Complement with HEJSTA white framed glass door and EKÖPING cover panels, decorative trim, and toe kicks as your finishing pieces.



NICKEBO
Color/design: Matte anthracite
Material: Foil finish

NICKEBO fronts with matte black surface create a stylish and modern look. A simple design that you can make your own. Made from recycled wood with a foil finish from mainly recycled plastic. Complement with HEJSTA reeded glass door.

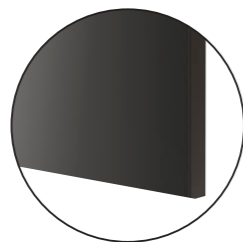

NICKEBO
Color/design: Matte green
Material: Foil finish

NICKEBO fronts with matte black surface create a stylish and modern look. A simple design that you can make your own. Made from recycled wood with a foil finish from mainly recycled plastic. Complement with HEJSTA reeded glass door.

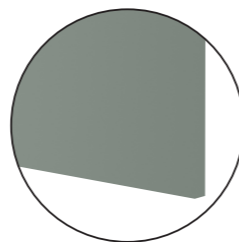

Sleek doors and drawer fronts



VEDDINGE
Color/design: White
Material: Painted finish

VEDDINGE white is a smooth, sleek door that gives your kitchen a bright, modern look. Complement with HEJSTA accent door.

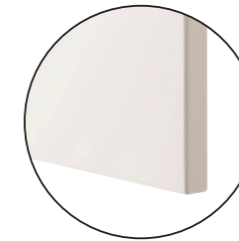

VALLSTENA
Color/design: White
Material: Foil finish with plastic edging

Simplicity at its best! VALLSTENA kitchen fronts have a smooth clean surface that is easy to coordinate and easy to like. A timeless expression that always feels right. Complement with HEJSTA glass door.

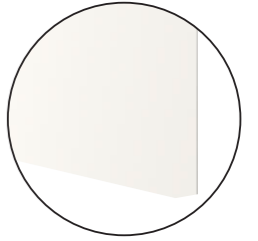

SINARP
Color/design: Oak veneer with solid oak edging
Material: Tinted lacquer finish

SINARP offers a timeless design with a modern twist, in dark wood tones that are full of character. The solid oak edging elegantly outlines the front adding fine detail and warmth to your kitchen. Complement with HEJSTA glass door.

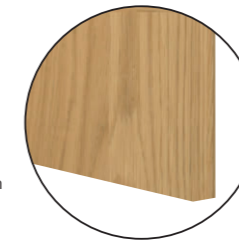

SINARP
Color/design: Brown
Material: Stain and lacquer finish

SINARP offers a timeless design with a modern twist, in dark wood tones that are full of character. The solid oak edging elegantly outlines the front adding fine detail and warmth to your kitchen. Complement with HEJSTA glass door.



Framed doors and drawer fronts

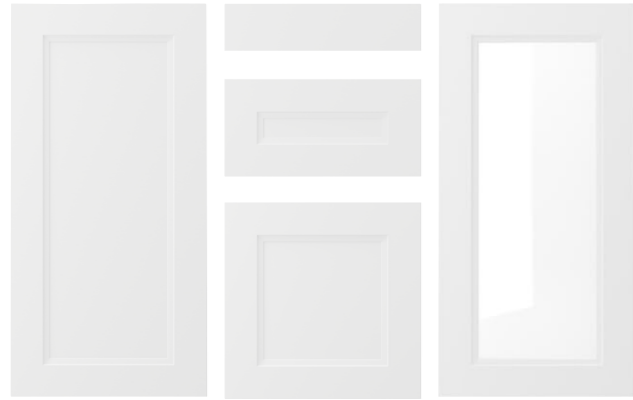

AXSTAD
Color/design: Matte white
Material: Foil finish

AXSTAD door has a matte, white surface with soft lines and a recessed center panel. The design allows you to use it to create both a modern and traditional kitchen. Complement with AXSTAD tempered glass doors.



AXSTAD
Color/design: Matte gray-green
Material: Foil finish

AXSTAD door has a matte, gray-green surface with soft lines and a recessed center panel. The tranquil color tone and traditional design give your kitchen a calm yet expressive atmosphere. Complement with AXSTAD tempered glass doors.

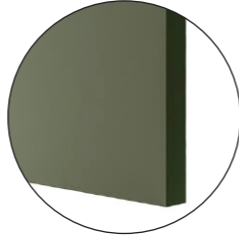

BODBYN
Color/design: Off-white
Material: Painted finish

Rich in detail, BODBYN off-white door has a panel that is bevelled on the inside and contoured on the outside. It gives your kitchen a traditional touch. Complement with BODBYN tempered glass doors.



Framed doors and drawer fronts



ENKÖPING
Color/design: White wood effect
Material: Foil finish

ENKÖPING has a classic look in white that feels inviting and will outlast the test of time. ENKÖPING framed fronts are covered in durable foil with a subtle grain structure that gives an authentic, warm wood character.



ENKÖPING
Color/design: Brown walnut effect
Material: Foil finish

ENKÖPING has a classic look in brown walnut that feels inviting and will outlast the test of time. ENKÖPING framed fronts are covered in durable foil with subtle grain structure that gives an authentic wood character.

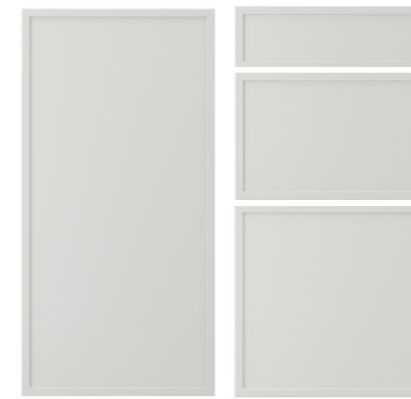

ASPUDDEN
Color/design: light gray.
No coordinating glass doors.
Material: Foil finish.

The elegant thin frame on ASPUDDEN fronts enhances the minimalist appeal, offering a timeless look with a subtle statement. The light gray finish brings a calm and inviting feel to your kitchen.

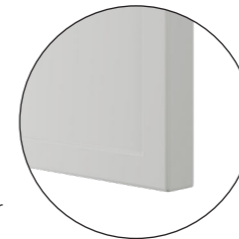

ASPUDDEN
Color/design: dark gray-green.
No coordinating glass doors.
Material: Foil finish.

The elegant thin frame on ASPUDDEN fronts enhances the minimalist appeal, offering a timeless look with a subtle statement. The dark gray-green finish creates a warm and welcoming kitchen expression.

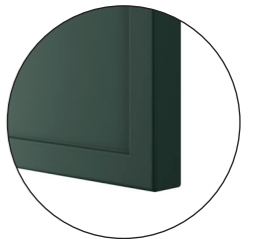

Framed doors and drawer fronts



LERHYTTAN
 Color/design: Light gray
 Material: Clear lacquered solid birch

LERHYTTAN door has a distinct traditional character, with a solid wood frame with bevelled edges and an inset veneer panel. It gives you a cozy kitchen with rustic charm. Complement with LERHYTTAN tempered glass doors.

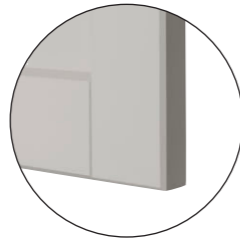

LERHYTTAN
 Color/design: Black stained
 Material: Stained ash veneer and solid ash

LERHYTTAN door has a distinct traditional character, with a solid wood frame, bevelled edges and a recessed veneer center panel. LERHYTTAN creates a cozy kitchen with rustic charm. Complement with LERHYTTAN tempered glass doors.



LERHYTTAN
 Color/design: Blue
 Material: Stained, tinted clear lacquered solid birch and birch veneer

LERHYTTAN door has a distinct traditional character, with a solid wood frame with bevelled edges and an inset veneer panel. LERHYTTAN creates a cozy kitchen with rustic charm. Complement with LERHYTTAN tempered glass doors.



VEDHAMN
 Color/design: Oak
 Material: Solid oak

VEDHAMN kitchen fronts in natural warm wood welcome you and make you feel right at home. The solid oak frame doors with oak veneer panels offer a beautiful, robust construction with attention to detail.



Doors and drawer fronts with integrated handles

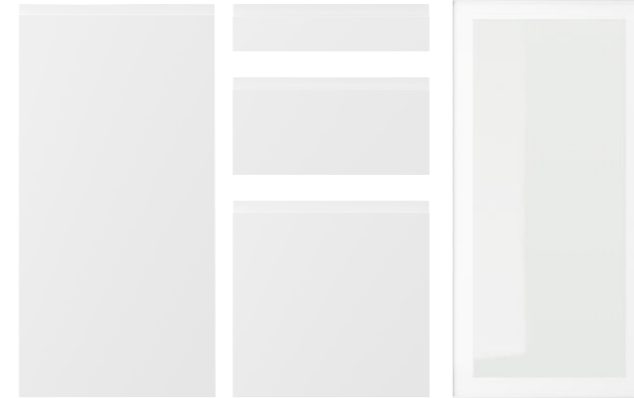

VOXTORP
 Color/design: Matte white
 Material: Foil finish

VOXTORP is a smooth, matte door with integrated handles. It brings clean lines and an open, modern look to your kitchen. Complement with HEJSTA glass door.

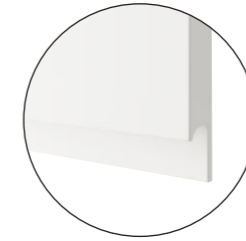

VOXTORP
 Color/design: Dark gray
 Material: Foil finish

VOXTORP is a smooth door with integrated handles. It brings clean lines and an open, modern look to your kitchen. Complement with HEJSTA glass door.

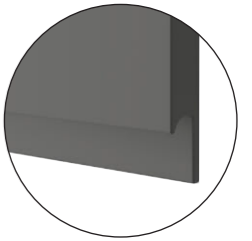

VOXTORP
 Color/design: High gloss dark gray-brown
 Material: Foil finish

VOXTORP is a smooth, high-gloss door with integrated handles. It brings clean lines and an open, modern look to your kitchen. Spills and stains wipe off easily. Complement with HEJSTA glass door.

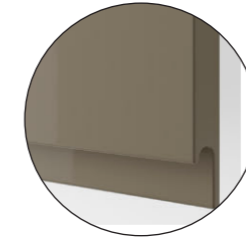

Accent drawer fronts

Accent drawer fronts are a great way to get a more personal look by adding a contrast, a pattern or a splash of color. They're designed to complement the other doors in your kitchen, which means they don't come in as many sizes as other fronts.

FROJERED bamboo accent drawer fronts can add a touch of warmth to your kitchen. And with stainless steel NOGSTA, you can bring that industrial, restaurant feel to your kitchen.

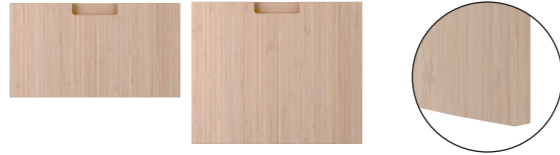

FRÖJERED Drawer front

Color/design: Light bamboo
Material: Bamboo

W18×H10"	004.416.35
W18×H15"	804.416.36
W24×H10"	604.416.37
W24×H15"	404.416.38
W30×H10"	204.416.39
W30×H15"	804.416.41



STENSTA Drawer front

Color/design: Dark brown
Material: Ash veneer

W18×H10"	105.609.63
W18×H15"	905.609.64
W24×H10"	605.609.65
W24×H15"	405.609.66
W30×H10"	205.609.67
W30×H15"	005.609.68
W36×H10"	005.928.27
W36×W15"	805.928.28



NOGSTA Drawer front

Color/design: Stainless steel
Material: Stainless steel

W18×H10"	505.315.96
W18×H15"	305.315.97
W24×H10"	105.315.98
W24×H15"	905.315.99
W30×H10"	505.316.00
W30×H15"	305.316.01

HEJSTA Glass doors

HEJSTA glass doors are very versatile fronts that blend perfectly with many of our other kitchen doors and drawer fronts. Handles are included.

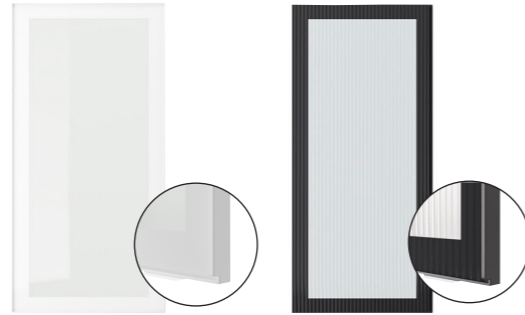

HEJSTA

Color/design: Glass doors and aluminum frame and a printed border.
Material: Tempered glass, glass enamel and aluminum with epoxy powder-coating

HEJSTA white with clear glass or anthracite with reeded glass doors are versatile and blend perfectly with all our other kitchen fronts. A perfect option if you've chosen a family of fronts with no glass doors. Handles included.

White with clear glass	
W15×H30"	805.266.21
W15×H40"	405.266.23
W18×H30"	905.266.25
W18×H40"	505.266.27

Anthracite with reeded glass	
W15×H30"	605.266.22
W15×H40"	205.266.24
W18×H30"	705.266.26
W18×H40"	305.266.28

High-gloss doors and drawer fronts

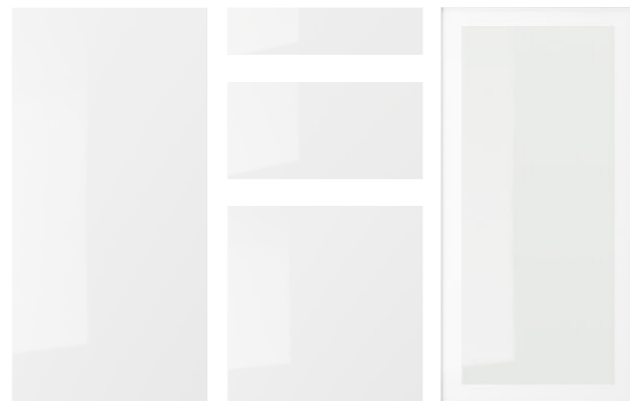

RINGHULT

Color/design: High-gloss white
Material: High-gloss foil finish

RINGHULT white doors have sleek, straight lines and a high-gloss surface that's durable and easy to clean. RINGHULT brings a bright, modern look to your kitchen. Complement with HEJSTA glass door.



Cover panels, decorative moldings, toekicks and legs

Add the finishing touches

Whether you've decided to go for a more traditional style with lots of drawers and decorative elements, or a sleek modern, more minimalistic style, there are still finishing touches for you to add to make your kitchen stunning.

Enhance your style with uniform cover panels, decorative moldings, legs and toekicks. Or, you can be a bit bold and go for a finish that contrasts with your doors and drawers. It's all up to you.

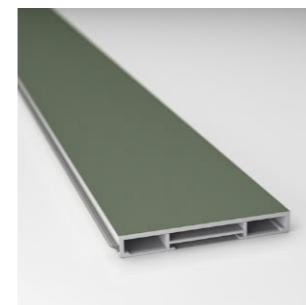

Decorative toekick



Cover panel



Decorative molding

*product varies by door style

Cover panels

Choose a cover panel in the same finish as your door for a uniform expression, or mix and match to suit your taste.

ASPUDDEN Decorative cover panel Light gray



New

W15×H30"	405.963.62
W25×H30"	205.963.63

ENKOPING Cover panel White wood

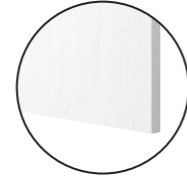

W15×H31½"	205.059.28
W15×H41½"	005.059.29
W15×H90"	805.059.30
W25×H30"	605.059.31
W25×H80"	405.059.32
W25×H90"	205.059.33
W26×H36"	005.059.34
W36×H96"	705.059.35

LERHYTTAN Cover panel Stained black

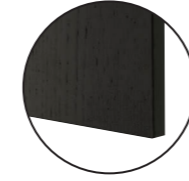

W15×H32½"	803.559.21
W15×H42½"	603.559.22
W15×H90"	403.559.23
W25×H30"	203.559.24
W25×H80"	903.559.25
W25×H90"	703.559.26
W26×H36"	503.559.27
W36×H96"	303.559.28

STENSTA Cover panel Dark brown



W15×H30"	505.609.61
W25×H30"	305.609.62

ASPUDDEN Decorative cover panel Dark gray/green



New

W15×H30"	206.033.87
W25×H30"	406.033.86

FRÖJERED Cover panel Light bamboo



W15×H30"	604.416.23
W25×H30"	404.416.24

LERHYTTAN Cover panel Blue

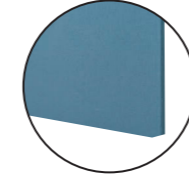

W15×H32½"	206.014.87
W15×H42½"	006.014.88
W15×H90"	806.014.89
W25×H30"	606.014.90
W25×H80"	406.014.91
W25×H90"	206.014.92
W26×H36"	006.014.93
W36×H96"	806.014.94

VALLSTENA Cover panel White

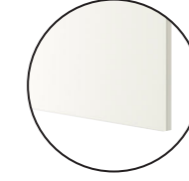

W15×H31½"	505.965.78
W15×H41½"	305.965.79
W15×H90"	105.965.80
W25×H30"	905.965.81
W25×H80"	705.965.82
W25×H90"	505.965.83
W26×H36"	305.965.84

ASPUDDEN Cover panel Light gray



New

W15×H32½"	205.963.05
W15×H42½"	005.963.16
W15×H90"	805.963.17
W25×H30"	605.963.18
W25×H80"	405.963.19
W25×H90"	205.963.20
W26×H36"	005.963.21
W36×H96"	805.963.22

HAVSTORP Cover panel Beige

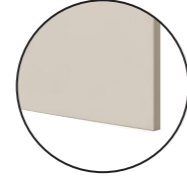

W15×H32½"	104.752.86
W15×H42½"	904.752.87
W15×H90"	704.752.88
W25×H30"	504.752.89
W25×H80"	304.752.90
W25×H90"	104.752.91
W26×H36"	904.752.92
W36×H96"	704.752.93

NICKEBO Cover panel Matte gray-green

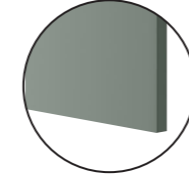

W15×H32½"	505.625.64
W15×H42½"	205.625.65
W15×H90"	005.625.66
W25×H30"	805.625.67
W25×H80"	605.625.68
W25×H90"	405.625.69
W26×H36"	205.625.70
W36×H96"	005.625.71

VEDHAMN Cover panel Oak



W15×H31½"	805.051.38
W15×H41½"	605.051.39
W15×H90"	405.051.40
W25×H30"	205.051.41
W25×H80"	005.051.42
W25×H90"	605.051.44
W26×H36"	305.051.45
W36×H96"	105.051.46

ASPUDDEN LERHYTTAN Cover panel Dark gray/green



New

W15×H31¾"	106.033.78
W15×H41½"	906.033.79
W15×H90"	706.033.80
W25×H30"	506.033.81
W25×H80"	306.033.82
W25×H90"	106.033.83
W26×H36"	906.033.84
W36×H96"	606.033.85

HAVSTORP Cover panel Light gray

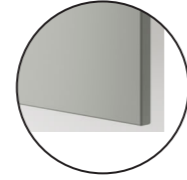

W15×H32½"	605.877.81
W15×H42½"	405.877.82
W15×H90"	205.877.83
W25×H30"	005.877.84
W25×H80"	705.877.85
W25×H90"	505.877.86
W26×H36"	305.877.87
W36×H96"	105.877.88

SINARP Cover panel Oak



W15×H32½"	906.034.40
W15×H42½"	306.034.43
W15×H90"	106.034.44
W25×H30"	806.034.45
W25×H80"	606.034.46
W25×H90"	406.034.47
W26×H36"	
W36×H96"	

VOXTORP Cover panel High gloss dark gray-brown

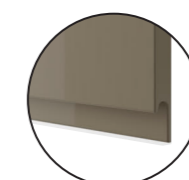

W15×H32½"	606.017.20
W15×H42½"	406.017.21
W15×H90"	206.017.22
W25×H30"	006.017.23
W25×H80"	806.017.24
W25×H90"	506.017.25
W26×H36"	306.017.26
W36×H96"	106.017.27

ASKERSUND Cover panel Light ash wood effect



W15×H32½"	403.483.48
W15×H42½"	203.483.49
W15×H90"	003.483.50
W25×H30"	803.483.51
W25×H80"	603.483.52
W25×H90"	403.483.53
W26×H36"	203.483.54
W36×H96"	803.483.94

HAVSTORP Cover panel Deep green

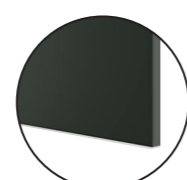

W15×H32½"	305.763.88
W15×H42½"	105.763.89
W15×H90"	905.763.90
W25×H30"	705.763.91
W25×H80"	505.763.92
W25×H90"	305.763.93
W26×H36"	105.763.94
W36×H96"	805.763.95

SINARP Cover panel Brown



W15×H32½"	604.046.73
W25×H30"	305.609.62
W25×H80"	704.046.77
W25×H90"	504.046.78
W26×H36"	304.046.79
W36×H96"	104.046.80

AXSTAD Cover panel Gray-green

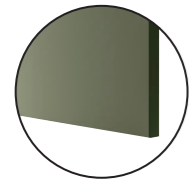

W15×H32½"	505.639.12
W15×H42½"	305.639.13
W15×H90"	105.639.14
W25×H30"	805.639.15
W25×H80"	605.639.16
W25×H90"	405.639.17
W26×H36"	205.639.18
W36×H96"	005.639.19

LERHYTTAN Cover panel Light gray

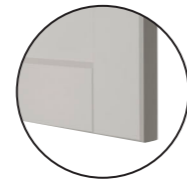

W15×H31¾"	803.532.34
W15×H41½"	503.532.35
W15×H90"	303.532.36
W25×H30"	103.532.37
W25×H80"	903.532.38
W25×H90"	703.532.39
W26×H36"	503.532.40
W36×H96"	303.532.41

NOGSTA Cover panel Stainless steel

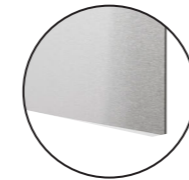

W15×H31½"	405.315.92
W25×H30"	205.315.93

NOGSTA Cover panel with legs Stainless steel

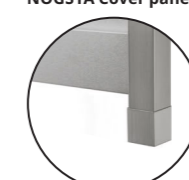

W15×H31½"	005.315.94
W25×H30"	705.315.95

FÖRBÄTTRA Cover panels

Our FÖRBÄTTRA cover panels are developed to fit all our various white doors and drawer fronts. Choose a FÖRBÄTTRA in the same color and finish as your door for a perfect match.

FÖRBÄTTRA Cover panel Off-white

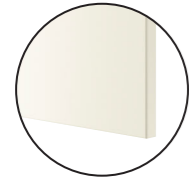

W15×H32½"	602.664.07
W15×H42½"	402.664.08
W15×H90"	202.664.09
W25×H30"	802.664.11
W25×H80"	402.664.13
W25×H90"	202.664.14
W26×H36"	602.664.12
W36×H96"	902.664.15

FÖRBÄTTRA Cover panel White

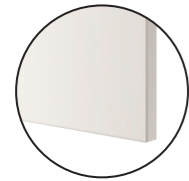

W15×H32½"	302.664.37
W15×H42½"	102.664.38
W15×H90"	902.664.39
W25×H30"	702.664.40
W25×H80"	302.664.42
W25×H90"	102.664.43
W26×H36"	502.664.41
W36×H96"	902.664.44

FÖRBÄTTRA Cover panel Dark gray

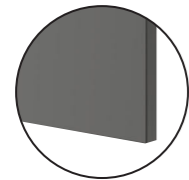

W15×H32½"	804.561.28
W15×H42½"	604.561.29
W15×H90"	404.561.30
W25×H30"	204.561.31
W25×H80"	004.561.32
W25×H90"	804.561.33
W26×H36"	604.561.34
W36×H96"	304.561.35

FÖRBÄTTRA Cover panel Brown walnut



W15×H31½"	305.167.09
W15×H41½"	105.167.10
W15×H90"	905.167.11
W25×H30"	705.167.12
W25×H80"	505.167.13
W25×H90"	305.167.14
W26×H36"	005.167.15
W36×H96"	805.167.16

FÖRBÄTTRA Cover panel High-gloss white



W15×H32½"	904.002.87
W15×H42½"	704.002.88
W15×H90"	504.002.89
W25×H30"	304.002.90
W25×H80"	104.002.91
W25×H90"	904.002.92
W26×H36"	704.002.93
W36×H96"	504.002.94

FÖRBÄTTRA Cover panel Matte white



W15×H32½"	504.177.46
W15×H42½"	304.177.47
W15×H90"	104.177.48
W25×H30"	904.177.49
W25×H80"	704.177.50
W25×H90"	504.177.51
W26×H36"	304.177.52
W36×H96"	104.177.53

FÖRBÄTTRA Cover panel Matte anthracite

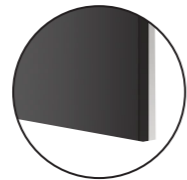

W15×H32½"	204.706.84
W15×H42½"	904.706.85
W15×H90"	704.706.86
W25×H30"	504.706.87
W25×H80"	304.706.88
W25×H90"	104.706.89
W26×H36"	904.706.90
W36×H96"	704.706.91

Decorative moldings

Decorative moldings provides the finishing touch to your kitchen. They come in many different styles, but we have something for all of our door and drawer families. Use them to tie your style together, hide lighting or just as a decorative element.

You can choose how to mount them on your cabinets. Below we show the entire range and some different ways of mounting them, both above as moldings and below your cabinet, either wrapped around the whole cabinet or just between your cover panels.

ASKERSUND Decorative molding rounded

Light ash wood effect

87×2¾" 803.318.50



AXSTAD Decorative molding rounded

Gray-green

87×2¾" 505.639.26



BODBYN Decorative molding contoured

Off-white

87×2¾" 804.177.59



ENKOPING Decorative molding contoured

White wood

87×1½" 805.057.51



Decorative moldings

HAVSTORP Decorative molding rounded
Light gray
87×2¾" 905.684.70



HAVSTORP Decorative molding rounded
Beige
87×2¾" 604.752.55



HAVSTORP Decorative molding rounded
Deep green
87×2¾" 405.683.64

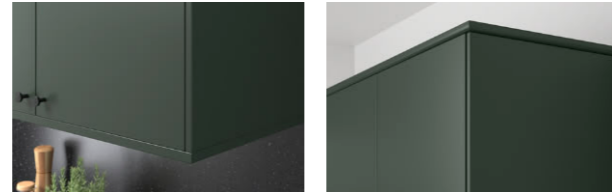

LERHYTTAN Decorative molding contoured
Stained black
87×1¾" 903.560.91



LERHYTTAN Decorative molding contoured
Light gray
87×1¾" 903.523.71



LERHYTTAN Decorative molding contoured
Blue
87×½" 205.949.86



NICKEBO Decorative molding rounded
Matte gray-green
87×½" 905.625.62

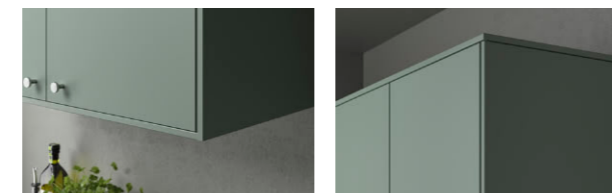

SINARP Decorative molding rounded
Oak
87×2¾"



SINARP Decorative molding rounded
Brown
87×2¾" 104.041.47

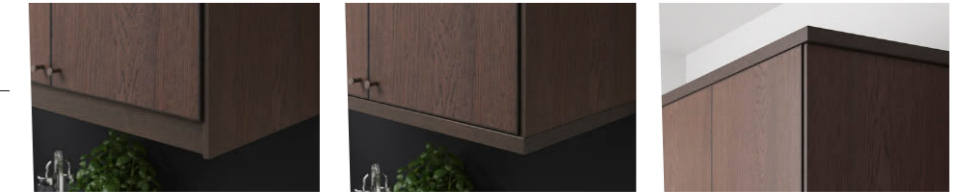

VEDHAMN Decorative molding contoured
Oak
87×1½" 205.003.70



VOXTORP Decorative molding rounded
High gloss dark gray-brown
87×2¾" 505.817.51



FÖRBÄTTRA Decorative moldings

Our FÖRBÄTTRA decorative moldings are developed to fit all our various white doors and drawer fronts. Choose a FÖRBÄTTRA in the same color and finish as your door for a perfect match.

FÖRBÄTTRA Decorative molding rounded Off-white

87×2¾" 702.069.60



FÖRBÄTTRA Decorative molding, rounded White

87×2¾" 202.978.87



FÖRBÄTTRA Decorative molding, rounded High-gloss white

87×2¾" 503.974.80



FÖRBÄTTRA Decorative molding, rounded Matte white

87×2¾" 704.176.65



FÖRBÄTTRA Decorative molding, rounded Dark gray

87×2¾" 504.540.84



FÖRBÄTTRA Decorative molding, rounded Matte anthracite

87×2¾" 005.267.43



FÖRBÄTTRA Decorative molding contoured Brown walnut

87×2½" 005.584.80



Toekicks and legs

Choose between a regular or a decorative toekick to cover the gap between your cabinet and the floor. As an alternative to a toekick you can also choose to put legs on your base and high cabinets.

LERHYTTAN Light gray



Standard toekick 84×4½"

604.825.43

Legs for decorative toekick

503.978.14 2pk

Corner legs for decorative toekick

004.032.33 2pk

LERHYTTAN Stained black

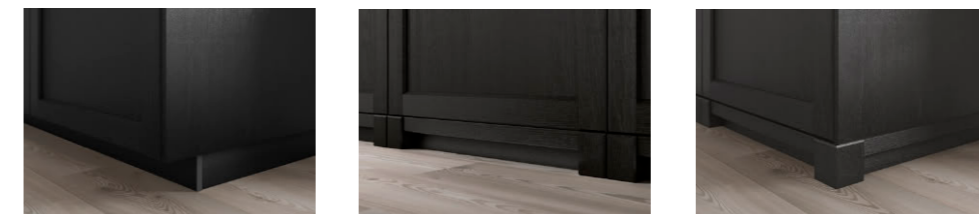

Standard toekick 84×4½"

303.559.71

Legs for decorative toekick

703.978.13 2pk

Corner legs for decorative toekick

804.032.29 2pk

LERHYTTAN Blue

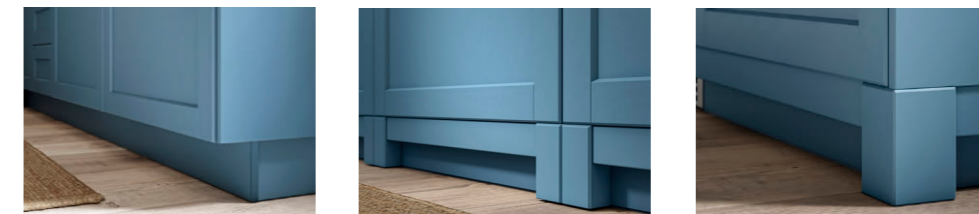

Standard toekick 84×4½"

206.015.38

Legs for decorative toekick

406.015.37 2pk

Corner legs for decorative toekick

406.014.86 2pk

Standard toekicks

ASKERSUND Light ash wood effect



Toekick 84×4½"

003.483.93

FÖRBÄTTRA Brown walnut



Toekick 84×4½"

105.585.59

STENSTA Dark brown



Toekick 84×4½"

305.921.28

Toekicks and legs

Standard toekicks

AXSTAD Gray-green



Toekick 84×4½"
505.640.06

HAVSTORP Light gray



Toekick 84×4½"
505.878.28

HAVSTORP Beige



Toekick 84×4½"
204.752.95

HAVSTORP Deep green



Toekick 84×4½"
505.764.34

NICKEBO Matte gray-green



Toekick 84×4½"
805.625.72

SINARP Oak

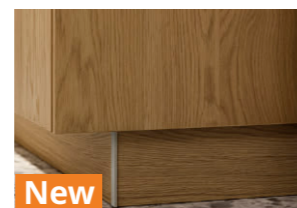

Toekick 84×4½"
206.111.89

SINARP Brown

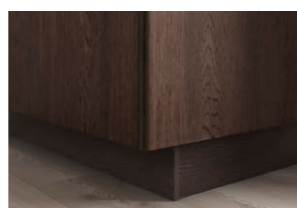

Toekick 84×4½"
704.047.24

VEDHAMN Oak

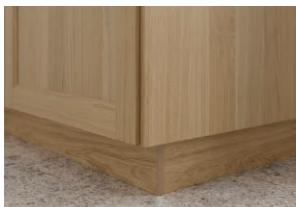

Toekick 84×4½"
305.051.88

VOXTORP High gloss dark gray-brown



Toekick 84×4½"
706.017.29

NOGSTA Stainless steel-color



Toekick 84×4½"
105.316.02

NOGSTA Stainless steel



Cover panel with legs
W15×H31½" 005.315.94
W25×H30" 705.315.95



SEKTION Legs H3½-5½".
May be completed with toekick.

905.560.71 **4pk**



VEDHAMN Legs H4¾".

Oak 105.054.10 **2pk**



CAPITA Legs H4-5".

Stainless steel 602.635.74 **4pk**



VEDHAMN Corner legs H4¾".

Oak 305.054.09 **2pk**

FÖRBÄTTRA Toekicks and legs

Our FÖRBÄTTRA toekicks and legs are developed to fit all our various white doors and drawer fronts. Choose a FÖRBÄTTRA in the same white color and finish as your door for a perfect match.

FÖRBÄTTRA Off-white



Standard toekick 84×4½"

402.875.90



Decorative toekick 87×4½"

002.786.77



Decorative toekick with cut out
26¾×4½"

702.930.85



Legs 4½"

402.786.75 **2pk**

FÖRBÄTTRA White



Standard toekick 84×4½"
602.668.17

FÖRBÄTTRA High-gloss white



Standard toekick 84×4½"
204.002.95

FÖRBÄTTRA Matte white



Standard toekick 84×4½"
904.177.54

FÖRBÄTTRA Dark gray



Standard toekick 84×4½"
704.561.81

FÖRBÄTTRA Matte anthracite



Standard toekick 84×4½"
204.707.35



FÖRBÄTTRA
Decorative toekick
Off-white
002.786.77

SEKTION cabinets

Modular cabinets that fits your space

What does your dream kitchen look like? How much time will you spend in it and how will you use it? When it comes to kitchens, we're all different. We have different dreams, different needs and different preconditions. To meet this diversity, what could be better than a highly flexible kitchen system with cabinets that can suit everyone, and be planned in everywhere? Whatever the size of your home or family, with cabinets in different sizes, drawers with endless possibilities and interior organizers made to match, you can turn the kitchen of your dreams into the kitchen in your home.

25
Year Limited
Warranty
Included

IKEA SEKTION kitchen has a free 25-year limited warranty.
Find out more on [page 122](#).



On this page you can see all available SEKTION cabinets and their sizes.
Choose and mix them to fit the architecture of your room as well as your own needs.



SEKTION Base cabinets

-  **SEKTION Base cabinet frame W12xD24xH30".**
White 102.653.92
-  **SEKTION Base cabinet frame W15xD24xH30".**
White 002.653.97
-  **SEKTION Base cabinet frame W18xD24xH30".**
White 202.653.96
-  **SEKTION Base cabinet frame W24xD24xH30".**
White 902.653.88
-  **SEKTION Base cabinet frame W30xD14¼xH30".**
White 502.653.90
-  **SEKTION Base cabinet frame W30xD24xH30".**
White 302.653.86
-  **SEKTION Base cabinet frame W36xD24xH30".**
White 802.653.98





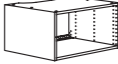





SEKTION Base cabinet for built-in oven







-  **SEKTION Base cabinet for oven W30xD24xH30".**
White 502.986.49

SEKTION Top cabinets

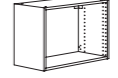
-  **SEKTION Fridge/freezer top cabinet frame W30xD24xH15".**
White 602.655.11
-  **SEKTION Fridge/freezer top cabinet frame W30xD24xH20".**
White 402.655.12
-  **SEKTION Fridge/freezer top cabinet frame W36xD24xH15".**
White 002.655.09
-  **SEKTION Fridge/freezer top cabinet frame W36xD24xH20".**
White 202.655.13

SEKTION Wall cabinets

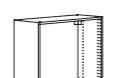
-  **SEKTION Wall cabinet frame W12xD14¼xH30".**
White 102.654.72
-  **SEKTION Wall cabinet frame W12xD14¼xH40".**
White 902.654.73
-  **SEKTION Wall cabinet frame W15xD14¼xH30".**
White 902.654.54
-  **SEKTION Wall cabinet frame W15xD14¼xH40".**
White 002.654.63
-  **SEKTION Wall cabinet frame W18xD14¼xH30".**
White 802.654.64
-  **SEKTION Wall cabinet frame W18xD14¼xH40".**
White 002.654.58
-  **SEKTION Wall cabinet frame W24xD14¼xH15".**
White 302.654.66
-  **SEKTION Wall cabinet frame W24xD14¼xH20".**
White 202.654.57
-  **SEKTION Wall cabinet frame W24xD14¼xH30".**
White 702.654.50
-  **SEKTION Wall cabinet frame W24xD14¼xH40".**
White 502.654.70
-  **SEKTION Wall cabinet frame W30xD14¼xH15".**
White 202.654.62

-  **SEKTION Wall cabinet frame W30xD14¼xH20".**
White 102.654.53
-  **SEKTION Wall cabinet frame W30xD14¼xH30".**
White 702.654.69
-  **SEKTION Wall cabinet frame W30xD14¼xH40".**
White 902.654.68
-  **SEKTION Wall cabinet frame W36xD14¼xH15".**
White 402.654.56
-  **SEKTION Wall cabinet frame W36xD14¼xH20".**
White 302.654.71
-  **SEKTION Wall cabinet frame W36xD14¼xH30".**
White 902.654.49
-  **SEKTION Wall cabinet frame W36xD14¼xH40".**
White 602.654.60



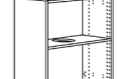

SEKTION Wall cabinet for built-in extractor hood

-  **SEKTION Wall cabinet for extractor hood with shelf W30xD14¼xH20".**
White 304.873.49
-  **SEKTION Wall cabinet for extractor hood with shelf W30xD14¼xH30".**
White 904.873.51

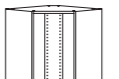

SEKTION High cabinets

	SEKTION High cabinet frame W15×D24×H80". White 802.654.40
	SEKTION High cabinet frame W15×D24×H90". White 102.654.48
	SEKTION High cabinet frame W18×D24×H80". White 002.654.44
	SEKTION High cabinet frame W18×D24×H90". White 002.654.39
	SEKTION High cabinet frame W24×D24×H80". White 202.654.38
	SEKTION High cabinet frame W24×D24×H90". White 702.654.45
	SEKTION High cabinet frame W30×D24×H80". White 204.874.15
	SEKTION High cabinet frame W30×D24×H90". White 404.874.19
	SEKTION High cabinet for fridge/freezer W24×D24×H80". White 804.997.31
	SEKTION High cabinet for fridge/freezer W24×D24×H90". White 004.997.30

SEKTION Corner cabinets

	SEKTION Corner base cabinet frame 38×24×30". White 705.967.56
	SEKTION Corner base cabinet frame W50×D26×H30". White 505.967.57
	SEKTION Corner wall cabinet frame W26×D26×H30". White 102.655.04
	SEKTION Corner wall cabinet frame W26×D26×H40". White 302.655.03

NYTTIG Fillers and separators







	NYTTIG Support bracket for microwave trim kit 104.844.55
	NYTTIG Cooktop/drawer separator Used for cooktop and drawer combination.
	30" 602.906.76
	36" 802.906.75

SEKTION Top rail

	SEKTION Reinforced ventilated top rail Galvanized. Use for sink and cook top base cabinet solutions.
	L24" 002.845.79
	L30" 802.845.80
	L36" 602.845.81

Open storage

Create a nice break in a row of cabinets with doors using open cabinets. Your kitchen becomes more personal and you can have often-used items like cookbooks within arm's reach.

	TORNVIKEN Open cabinet 9×14½×30" Off-white 103.590.36		TORNVIKEN Box 7½×13×5½". A flexible box that you can place in TORNVIKEN open cabinet and also lift out and place somewhere — like on the countertop or the dining table. White 803.590.33
	9×14½×40" Off-white 303.590.35		VADHOLMA Drawer unit 15×14½×15". Smooth-running drawers with stop, self-closing the last inches. You can view and access what's inside, as the drawers fully extend. Brown/stained ash 403.743.42
	VADHOLMA Open storage Brown/stained ash 9×14½×30" 003.743.44		VADHOLMA Wine shelf 15×14½×15". Brown/stained ash 503.743.46
	9×14½×40" 703.743.45		

Roll-front cabinet

	TITTEBO Roll-front cabinet Keeps smaller appliances hidden behind a closed door so your kitchen stays neat and tidy. Black 24×11¾×29¼" 205.692.27
---	---

Wall storage

	TORNVIKEN Wall shelf Off-white 19¾×11¾×9½" 803.935.17		KLAVRESTRÖM Wall shelf Oak 23¾×6¾×7⅞" 306.016.89
	47¼×11¾×9½" 603.916.61		

MAXIMERA Drawers and drawer accessories

MAXIMERA drawers fully extend, and thanks to a built-in damper they always close softly and quietly. You have a complete view and you can easily reach the smallest of utensils even at the back of the drawer. MAXIMERA drawers are available in different sizes to give you plenty of options depending on your storage needs. You can also add inner drawers to fully utilize the cabinet space.

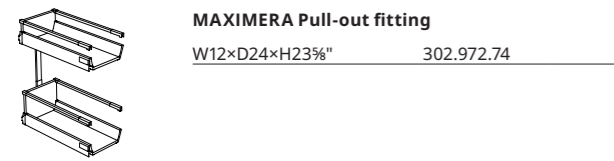

MAXIMERA Pull-out fitting

W12×D24×H23¾"	302.972.74
---------------	------------



MAXIMERA Drawer low, White

W15×D14¾×H3¾"	302.656.59
W18×D14¾×H3¾"	502.656.58
W24×D14¾×H3¾"	402.656.54
W30×D14¾×H3¾"	102.656.60
W36×D14¾×H3¾"	102.656.55
W15×D24×H3¾"	502.656.63
W18×D24×H3¾"	702.656.57
W24×D24×H3¾"	702.656.62
W30×D24×H3¾"	902.656.56
W36×D24×H3¾"	902.656.61



MAXIMERA Drawer medium, White

W15×D14¾×H5½"	402.656.73
W18×D14¾×H5½"	202.656.74
W24×D14¾×H5½"	402.656.68
W30×D14¾×H5½"	802.656.71
W36×D14¾×H5½"	202.656.69
W15×D24×H5½"	002.656.70
W18×D24×H5½"	002.656.65
W24×D24×H5½"	802.656.66
W30×D24×H5½"	302.656.64
W36×D24×H5½"	602.656.67



MAXIMERA Drawer high, White

W24×D17¾×H8¾"	402.766.95
W30×D17¾×H8¾"	202.766.96
W36×D17¾×H8¾"	002.766.97
W15×D24×H8¾"	302.656.78
W18×D24×H8¾"	502.656.82
W24×D24×H8¾"	102.656.79
W30×D24×H8¾"	702.656.76
W36×D24×H8¾"	102.656.84



UTRUSTA Drawer front low, White

W15×H3¾"	402.656.25
W18×H3¾"	602.656.29
W24×H3¾"	802.656.28
W30×H3¾"	202.656.26
W36×H3¾"	002.656.27



UTRUSTA Drawer front medium, White

W15×H6½"	602.656.34
W18×H6½"	102.656.36
W24×H6½"	202.656.31
W30×H6½"	002.656.32
W36×H6½"	802.656.33



UTRUSTA Drawer front high, White

W15×H8¾"	902.656.37
W18×H8¾"	702.656.38
W24×H8¾"	502.656.39
W30×H8¾"	302.656.40
W36×H8¾"	902.656.42



UTRUSTA Pull out larder, Galvanized

Fitting only, cabinet and doors sold separately.

W21¾×D22½×H49¾"	105.177.95
-----------------	------------



UTRUSTA under-sink organizer

White	606.123.99	2pk
-------	------------	-----

MAXIMERA Add-ons and UPDATERA Dividers



MAXIMERA Add-on sides for drawer, medium Glass

D14¾"	702.388.62	2pk
D24"	302.388.59	2pk



UPDATERA Divider for drawer White

W15"	804.914.43
W24"	604.914.44
W30"	304.914.45



MAXIMERA Add-on sides for drawer, high Glass

D24"	502.388.58	2pk
------	------------	-----

UTRUSTA Shelves



UTRUSTA Shelves W12×D14¾"

White	402.655.31	2pk
-------	------------	-----



UTRUSTA Shelves W12×D24"

White	902.655.24	2pk
-------	------------	-----



UTRUSTA Shelves W15×D14¾"

Glass	202.656.07	2pk
White	802.655.48	2pk



UTRUSTA Shelves W15×D24"

White	602.655.25	2pk
-------	------------	-----



UTRUSTA Shelves W18×D14¾"

Glass	002.656.13	2pk
White	802.655.29	2pk



UTRUSTA Shelves W18×D24"

White	202.655.32	2pk
-------	------------	-----



UTRUSTA Shelves W24×D14¾"

White	102.655.23	2pk
-------	------------	-----



UTRUSTA Shelves W24×D24"

White	002.655.33	2pk
-------	------------	-----



UTRUSTA Shelves W30×D14¾"

Glass	802.656.09	2pk
White	502.655.35	2pk



UTRUSTA Shelves W30×D24"

White	002.655.28	2pk
-------	------------	-----



UTRUSTA Shelves W36×D14¾"

Glass	402.656.11	2pk
White	402.655.26	2pk



UTRUSTA Shelves W36×D24"

White	802.655.34	2pk
-------	------------	-----



UTRUSTA Shelf for corner wall cabinet W26"

Glass	802.656.14
White	702.656.19



UTRUSTA Reinforced ventilated shelf W30×D24"

White	704.873.47
-------	------------



UTRUSTA Pull-out work surface W22½×D21¾"

White	605.105.79
-------	------------



UTRUSTA Shelf for corner base cabinet W50"

White	605.967.66
-------	------------



UTRUSTA Shelf for corner base cabinet W38"

White	706.024.89
-------	------------

UTRUSTA Corner interior



UTRUSTA Wall corner cabinet carousel

Ø24"	802.656.47
------	------------

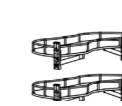

UTRUSTA Corner base cabinet pull-out fitting

Gray	
W50"	505.967.62



UTRUSTA Corner base cabinet carousel Gray

Ø38"	606.018.00
------	------------

UTRUSTA Wire basket



UTRUSTA Wire basket

W15×D24"	802.656.52
W18×D24"	202.656.50
W24×D24"	002.656.51



UTRUSTA Cleaning interior 13×20¾×52½"

Pull-out organizers make it easy for you to see and reach your cleaning supplies.

	105.808.24
--	------------

SEKTION system fittings and hinges

Even the smaller details are important when you are planning a complete kitchen. It all depends on your needs and wishes—but maybe it's just this small part that will make a big difference.



SEKTION Suspension rail 84"

Galvanized 602.615.27



SEKTION Ventilation grill 16 1/8 x 3 3/4"

Stainless steel 702.561.77



MAKRILLA Ventilated plinth 20 1/8 x 4 1/2"

Stainless steel 403.238.09



UTRUSTA Push opener, electrical. You can open the waste sorting bin with the push of a finger – or use your hip, knee or foot if your hands are busy.

302.387.03



UTRUSTA Push openers Push to open; no handles needed.

802.302.24

2pk

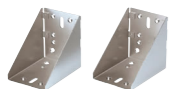

UTRUSTA Corner fittings By using the corner fitting, you can build a corner wall cabinet solution at a 90° angle.

Galvanized 103.436.44

2pk



UTRUSTA Hinges 95° Fits cabinets for built-in fridge/freezers.

202.046.47

2pk



UTRUSTA Hinges 110° With built-in damper.

805.248.82

2pk



UTRUSTA Hinges 153° With built-in damper. The extra wide opening angle of 153° makes it possible to have a drawer behind a door.

104.272.62

2pk



UTRUSTA Hinges with damper for horizontal door

Door lift with catch for gentle closing included.

White

804.654.15

2pk



UTRUSTA Hinges with push opener for horizontal door

Push to open, no handle needed. Door lift with catch included.

White

404.654.17

2pk



UTRUSTA Hinges for kitchen corner cabinet 95°

806.073.73

2pk



VARIERA Cover caps Covers drill holes in the glass door cabinet or open shelf. Suitable for all products with 3/16" holes.

White

002.263.15

100pk



UTRUSTA Connection fitting for doors UTRUSTA connection fitting for doors is used to connect two doors to one, so you get a uniform look, for example a high cabinet.

303.669.17



UTRUSTA Connecting rail for fronts You can easily align the drawer front with the other doors and drawer fronts in your kitchen and create a smooth, streamlined look with the help of UTRUSTA connection rail.

202.774.36

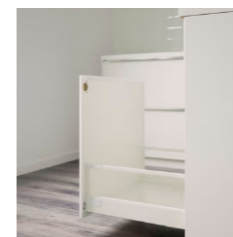

UTRUSTA Fitting for mounting drawer on door

002.807.55



UTRUSTA Assembly kit for pull-out function Allow you attach a door to your drawers to create a pull-out pantry storage, giving you a good overview of everything stored inside.

805.105.83



SEKTION Connecting rail for cabinet/cover panel

This rail helps you to connect your base cabinets back-to-back. It can also be used to attach a cover panel to the back side of base cabinet, giving your kitchen island or peninsula a uniform look.

005.570.32



SEKTION Floor anchor frame for kitchen island

This floor anchoring frame simplifies the task of securing your kitchen island or peninsula to make sure that it stays in place. The feet can be adjusted to level your frame on uneven floors.

105.570.36



VAGLIG Connection rail for panel-ready dishwasher

205.910.25

SEKTION interior fittings and organizers











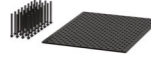
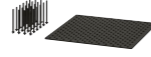

Hidden helpers

With SEKTION interior fittings and organizers, you can get the look you want on the outside without revealing what's inside. The cabinets can be hiding all sorts of kitchen surprises. Behind a door you can find pull-out organizers for your cleaning equipment, organizers keeping all your pots, pans and lids in perfect order, or a great bunch of fully extendable drawers making everything easy to reach. Not to mention drawers inside drawers allowing you to utilize the cabinet space to a maximum. It's really up to you what goes inside your kitchen cabinets.

On the following pages you'll find numerous handy helpers making your daily work in the kitchen so much easier.



UPPDATERA series

	UPPDATERA Flatware caddy L4¾×W4¾×H9½". Anthracite 404.331.05
	UPPDATERA Plate holder 6-9" Adjustable to fit your plates. Plate Ø6-9". W9-12×H6". Anthracite 704.861.78
	UPPDATERA Plate holder 7-12" Adjustable to fit your plates. Plate Ø7-12". W10-15×H6". Anthracite 504.861.79
	UPPDATERA Pegboard drawer organizer Includes 32 adjustable pegs. Fits in 30" frames. W25×D19½×H5¼". Anthracite 505.029.85
	UPPDATERA Pegboard drawer organizer Includes 24 adjustable pegs. Fits in 24" frames. W18¾×D19¾×H5¼". Anthracite 405.541.16
	UPPDATERA Knife rack W4×D20". Anthracite 804.913.63
	UPPDATERA Utensil tray W6×H12". White 204.914.03
	UPPDATERA Utensil tray W6×H19½". White 604.913.64
	UPPDATERA Flatware tray W15×D12". White 404.914.02
	UPPDATERA Flatware tray W12×D19½". White 704.914.10
	UPPDATERA Flatware tray W15×D19½". White 604.942.06
	Add NEW UPPDATERA spice rack 4 x 20". White 306.005.76
	UPPDATERA Tray with knife rack W6×D19½". White/anthracite 594.326.91
	UPPDATERA Utensil tray Light bamboo W5¾×D19½×H2½" 004.913.57 W6×D12×H2¼" 405.881.21

	UPPDATERA Adjustable organizer Gray A flexible organizer to manage the mess in your kitchen drawers. Simply cut and rearrange the dividers to fit your storage needs. The soft material dampens sound and upscales the look inside your drawers. W15" 805.441.92 W24" 405.441.94
	UPPDATERA Sliding organizer for drawer W23¾". Just when you thought there wasn't room for anything more inside your drawer, this sliding organizer works magic by creating extra storage for spice jars, rolls, utensils and more. Gray 005.441.86
	UPPDATERA Boxes Set of 3. 100% polyester. Gray 305.497.95
	UPPDATERA Flatware tray Light bamboo W19½×D5¾×H2½" 004.913.57 W12×D5¾×H2¼" 405.881.21 W14¾×D12×H2¼" 605.881.20 W12×D19½×H2½" 204.914.84 W15×D19½×H2½" 204.913.56
	UPPDATERA Tray with knife rack W6×D19½". Light bamboo/anthracite 194.327.06
	UPPDATERA Box 9½×6¾" Anthracite 805.040.49 Green 805.040.54 Light pink 105.040.57 White 205.464.67
	UPPDATERA Box 13¼×9½" White 405.464.71
	UPPDATERA Storage box 6¼×9½×6" Light Bamboo 405.207.20
	UPPDATERA Storage box 9½×12½×6" Light Bamboo 805.207.18

Additional interior fittings and organizers

	UPPDATERA Box with slider UPPDATERA box is easy to carry and take out of your kitchen drawers or shelves since it has two grip-friendly handles. Pulls out for easy reach and good overview, when connected to the UPPDATERA slider (to be mounted in the pre-drilled holes inside your kitchen cabinet). W5¾×D19¾×H4¾" Anthracite 895.907.16	
	VARIERA Pot lid organizer Stainless steel L3¼-19¾×W5¾×H4" 701.548.00	
	VARIERA Plastic bag dispenser Ideal for storing things like plastic bags, toilet/kitchen rolls, gloves and socks. White 800.102.22	
	VARIERA Drawer mat L59¼×W19¾". Transparent 800.128.53	
	UPPDATERA Drawer mat L31×W20". Gray 605.510.46	
	VARIERA Shelf insert White W12¾×D5½×H6¼" 801.366.22 W12¾×D11×H6¼" 601.366.23 W17¾×D11¾×H6¼" 805.429.61 W17¾×D5½×H6¼" 405.429.58	
	RISATORP Basket L9¾×W10¼×H7". White 902.816.18 Dark gray 205.887.11 Pink 805.886.90 Dark green 205.886.88	

Recycling

Our easy-to-clean bins are available in a variety of sizes so you can create the recycling solution that suits your needs. Pull-out functions can help make recycling and composting less of a chore.

Pull-out recycling tray

Make tossing things out and taking the bin to the curb more convenient.



Recycling center

Have two large bins for recycling paper, plastic, bottles and cans conveniently in your kitchen.



Recycling combinations

Choose the combination that best fits your needs. You can use waste bins behind cabinet doors or in high drawers.

24-30-36" cabinet with door/doors

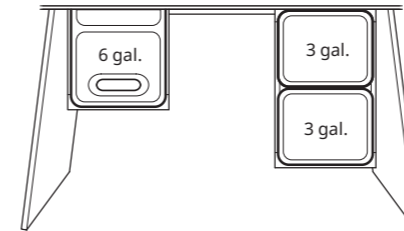

Behind cabinet doors, 36".

HÅLLBAR series

1 × Bin

6 gal. 204.202.03

2 × Bin

3 gal. 803.980.58

2 × Pull-out frame for recycling /ea
204.228.53

18" drawer

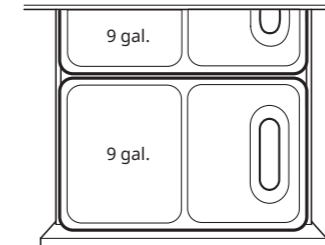

In a drawer, 18".

HÅLLBAR series

2 × Bin

9 gal. 504.202.06

30" drawer under sink

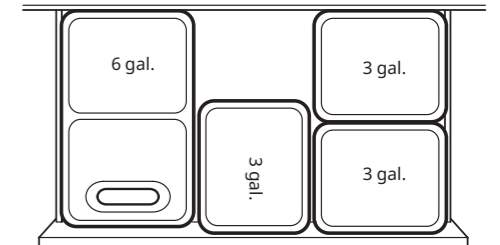

In a drawer under sink, 30".

HÅLLBAR series

1 × Bin

6 gal. 204.202.03

3 × Bin

3 gal. 803.980.58

HÅLLBAR recycling



HÅLLBAR Pull-out frame for recycling

L10³/₈×W17³/₄×H12³/₈" 204.228.53



HÅLLBAR Bin Light gray, 101 oz.

L7⁷/₈×W6³/₈×H6³/₄" 904.321.94



HÅLLBAR Bin Light gray, 3 gal.

L10³/₈×W8³/₈×H12⁷/₈" 803.980.58



HÅLLBAR Bin Light gray, 6 gal.

L15¹/₄×W10³/₈×H12⁷/₈" 204.202.03



HÅLLBAR Bin Light gray, 9 gal.

L15¹/₄×W9⁷/₈×H21¹/₈" 504.202.06



HÅLLBAR Recycling solution with pull-out Light gray, 5 gal.

793.088.03



HÅLLBAR Recycling solution with pull-out Light gray, 6 gal.

093.088.25



VARIERA Plastic bag dispenser White.

D5¹/₈×W6¹/₄×H17³/₄" 800.102.22



UTRUSTA Push opener Electrical.

302.387.03

Lighting and sound for SEKTION

A brighter kitchen life

Good lighting is an essential part of any kitchen. That's why we have different families of integrated lighting that are perfectly designed to fit into our kitchen cabinets. Including integrated lighting in your kitchen is the best way to show off your favourite dinnerware, behind glass doors or in drawers.

Worktop lighting helps you focus on function and makes kitchen work less of a chore. Preparing and cooking meals becomes safer, easier and more fun when you have a good, even light across your worktop.

Enjoy an even better kitchen life with the ability to light turn on and off wirelessly, or soften the light when you dine or socialise. All you need is a wireless dimmer or remote control. Or connect your smart lighting to DIRIGERA and connect all your lights together with other smart products in the IKEA Home Smart app.

You can choose the features and functions that are most important to you and add products to create your perfect kitchen atmosphere.



Drawer lighting simplifies finding what you need even during those midnight kitchen raids. Opening and closing the drawer turns the light on and off automatically.



Countertop lighting should give you a clean, clear view of all the work you're doing in the kitchen.



Spotlights provide a focused light that is good for lighting smaller areas and behind glass doors.

MITTLED series

MITTLED has a compact design for both under cabinets and inside drawers. And **hardwiring is not necessary**

Countertop lighting



Drawer lighting



Cabinet lighting



when installed with TRÅDFRI LED driver(s) and ANSLUTA power supply cord.



MITTLED LED dimmable countertop lighting Matches your cabinet sizes and features a compact design. LED life time approx. 25,000 hrs. Lamps are able to connect together for a seamless look and even task lighting across a run of connected wall cabinets. Lights are dimmable with TRÅDFRI LED driver, TRÅDFRI dimmer, and DIRIGERA hub, sold separately. **Note:** The VAGDAL connection cord is not included with MTTLED countertop lights, it must be purchased separately according to the number of connected lights you are using.

Only one VAGDAL connection cord is required per group of MTTLED countertop lights connected together. If installing a single MTTLED countertop light, one VAGDAL connection cord is needed for that unit. If connecting 3 MTTLED lights, 1 VAGDAL cord is needed.

The VAGDAL connection cords then connect to TRÅDFRI LED driver(s). The LED driver then connects to an electrical outlet using an ANSLUTA power supply cord, all sold separately.

White	L12", 3.3W	904.725.14
	L15", 4.3W	104.554.34
	L18", 5W	504.554.27
	L24", 6W	004.554.20

Purchase VAGDAL connection cord separately for each group of lights.



VAGDAL Connection cord		
	137¾"	704.636.00



MITTLED LED lighting strip for drawers In an IKEA kitchen you can have lighting inside all your drawers. Opening and closing the drawer turns the light on and off automatically. Must be completed with an LED driver. For drawer lighting, it is best to use a dedicated driver not connected to other lighting. Use either a TRÅDFRI driver coupled with ANSLUTA power supply cord or an ANSLUTA LED driver which already includes the power cord. All sold separately.

Why a dedicated driver? Drawer lighting must stay in an 'on' position so that the MTTLED lights on/off sensors operate properly. A dedicated LED driver for drawer lighting ensures there is no interference by other smart devices connected to TRÅDFRI drivers, such as dimmers, remote controls or wireless controls.

White	L14", 2W	404.635.26
	L17", 2W	504.720.40
	L23", 2W	604.635.54
	L29", 3.5W	204.635.70
	L34", 3.5W	304.720.41



MITTLED LED spotlight Interior cabinet lighting enhances the atmosphere and gives a good overview of things inside your glass door cabinets. Dimmable with TRÅDFRI LED driver, dimmer and ANSLUTA power supply cord, sold separately. Can be installed in its housing or integrated into coving. Ø2¾".

White	2.2W	404.536.45
	2.2W	504.721.39

Cabinet lighting



TVÄRDRAG Cabinet lighting A lovely traditional cabinet lamp. The metal shade creates a direct light that illuminates your cabinets. If you want the lamp's light to be directed into your display cabinet, just angle the lamp head inwards. You can turn up to 6 light sources on and off simultaneously if you complete with ANSLUTA driver. If you also want to be able to dim, choose TRÅDFRI driver and STYRBAR remote control instead, sold separately.

Black	1.5W	405.168.41
-------	------	------------



YTBBERG Cabinet lighting The lamp's slim and neat design goes with most styles and is perfect if space is limited between the top of your cabinet and the ceiling. You can easily direct the light where you like since the arm can be bent 180° and the lamp head angled 90°. You can turn up to 6 light sources on and off simultaneously if you complete with ANSLUTA driver. If you also want to be able to dim, choose TRÅDFRI driver and wireless dimmer instead. Sold separately.

Black	2W	105.278.98
White	2W	505.168.31



Cabinet lighting illuminates your favorite kitchen doors and creates a cozy mood light in the entire kitchen.

SKYDRAG Countertop lighting series



SKYDRAG LED countertop lighting with sensor Must be completed with TRÅDFRI LED driver and ANSLUTA power supply cord, sold separately. You can connect as many LED light strips as you like, as long as the total wattage of the products does not exceed the maximum wattage of the connected driver(s). Add the DIRIGERA hub and IKEA Home smart app for wireless control through Amazon Alexa, Apple HomeKit or Google Home. Dimmable with TRÅDFRI wireless dimmer, sold separately.

L18"	White	4W	004.395.95
	Black	4W	904.396.09
L24"	White	6W	404.396.02
	Anthracite	6W	104.791.66

SKYDRAG LED lighting is dimmable and long lasting. Lighting creates atmosphere in homes and makes everyday life easier. This LED worktop lighting has been specially designed for ENHET kitchen series, but is of course just as easy to install in an existing kitchen or also works great in AURDAL and BOAXEL wardrobe systems!

Countertops

Your kitchen is the heart of your home, it's a room for everyone! How it performs and how it looks are two important factors. Even though doors and drawer fronts are the main style decision you make when updating your kitchen, your countertop can have a big impact on the overall look. However, the perfect countertop is not just about completing the look of your kitchen, it has an impact on its functionality too. When picking the right countertop there are many factors to consider, including your style, durability, maintenance, lifestyle and cost. Our countertops are available in pre-cut and custom-made as well as in durable materials, finishes and thicknesses. Each surface has unique properties, with differing levels of water, wear and heat resistance.

How to choose your countertop:

1

What's your budget?
A stylish look does not have to cost a fortune, our countertops are available in wide range of materials and expressions, pre-cut as well as custom-made to perfectly fit your style, needs and wallet.

2

What kind of material do you prefer? When deciding on material, consider how robust you need your countertop to be, how much you are prepared to look after it, and how you want it to look in your kitchen environment.

3

Custom-made countertops are made-to-fit your kitchen layout, you can order the exact size you need, as well as cut-outs for your sink, faucet and cooktop. Pre-cut countertops are available in different sizes, you can take them home today and cut to desired length.

Built to last

When we test our countertops we put them up against everything they'll face in your kitchen: liquids, oil, steam, heat, thumps, bumps and scratches. Once we're done we're so sure our countertops will last for many years to come.

25
Year Limited
Warranty
Included

Countertops have a free 25-year limited warranty. Exclusions apply. See pages 122-123 or [IKEA.us.com/warranty](https://www.ikea.us.com/warranty) for details.



Materials

Laminate

Laminate countertops are durable, affordable and easy to maintain, with lots of colors and expressions to choose from. Spills and grease are easy to wipe clean and the countertop keeps its beauty over time, making it a practical solution.

Wood

Countertops with a top layer of wood have all the qualities of solid wood, enhanced by modern technology. They are made with 1/8" layer of solid wood wrapped on particleboard. This increases the stability and makes them less likely to split or crack. They can be sanded down to remove minor scratches, and will keep their natural beauty over the years.

Recycled glass

Countertops made of recycled glass offer a sleek and expressive look inspired by beautiful materials found in nature. The easy to care for, durable, non-porous surface is both stain- and moisture-resistant.

Color overview

We offer pre-cut laminate countertops in two lengths. Choose between the many colors and expressions to find the perfect look. The laminate countertops can be cut into the length you need and finished with the edge strip included in the package.



White



White marble effect



White lively marble effect



Light gray concrete effect



White/light gray stone effect



Gray beige stone effect

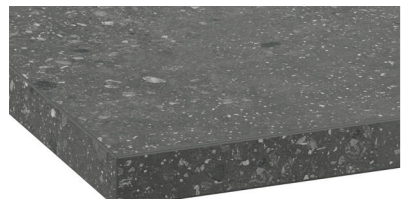

Gray terrazzo effect

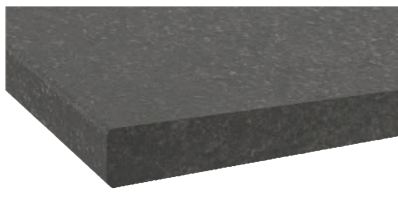

Dark gray stone effect



Terracotta effect



Plywood effect



Black



Ash effect



Bamboo veneer



Oak effect

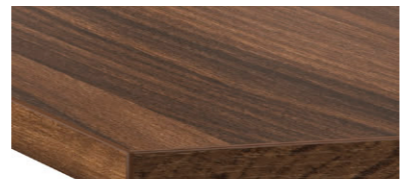

Brown walnut effect



Laminate countertops 1 1/8" thick

25
Year Limited
Warranty
Included

JÄRSTORP and EKBACKEN countertops have a free 25-year limited warranty. Find out more on pages 122-123.



JÄRSTORP Countertop
White

L74xD25% \times H1 1/8"	005.896.55
L98xD25% \times H1 1/8"	805.896.56
L74xD42 \times H1 1/8"	605.896.57



EKBACKEN Countertop
White marble effect

L74xD25% \times H1 1/8"	106.090.35
L98xD25% \times H1 1/8"	906.090.36
L74xD42 \times H1 1/8"	006.090.26



EKBACKEN Countertop
White lively marble effect

L74xD25% \times H1 1/8"	305.703.53
L98xD25% \times H1 1/8"	105.703.54
L74xD42 \times H1 1/8"	505.703.47



EKBACKEN Countertop
Light gray concrete effect

L74xD25% \times H1 1/8"	803.954.46
L98xD25% \times H1 1/8"	603.954.47
L74xD42 \times H1 1/8"	504.991.10

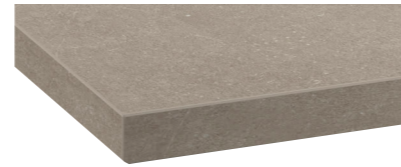

EKBACKEN Countertop
Gray beige stone effect

L74xD25% \times H1 1/8"	206.043.15
L98xD25% \times H1 1/8"	006.043.16
L74xD42 \times H1 1/8"	506.043.14

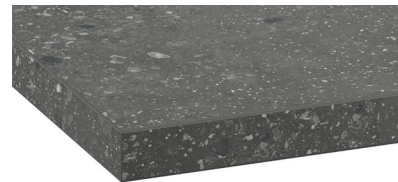

EKBACKEN Countertop
Gray terrazzo effect

L74xD25% \times H1 1/8"	306.090.15
L98xD25% \times H1 1/8"	106.090.16
L74xD42 \times H1 1/8"	806.090.08



EKBACKEN Countertop
Terracotta effect

L74xD25% \times H1 1/8"	306.090.58
L98xD25% \times H1 1/8"	106.090.59
L74xD42 \times H1 1/8"	506.090.57



EKBACKEN Countertop
Plywood effect

L74xD25% \times H1 1/8"	006.090.50
L98xD25% \times H1 1/8"	806.090.51
L74xD42 \times H1 1/8"	906.090.41



EKBACKEN Countertop
Ash effect

L74xD25% \times H1 1/8"	303.376.23
L98xD25% \times H1 1/8"	103.376.24



EKBACKEN Countertop
Brown walnut effect

L74xD25% \times H1 1/8"	604.764.86
L98xD25% \times H1 1/8"	004.429.89



EKBACKEN Countertop
Black

L74xD25% \times H1 1/8"	905.896.70
L98xD25% \times H1 1/8"	505.896.72

Laminate countertops 1 1/2" thick

25
Year Limited
Warranty
Included

HOLMARED, SÄLJAN and MÖCKLERYD countertops have a free 25-year limited warranty. Find out more on pages 112-113.



HOLMARED Countertop
Bamboo veneer

L74xD25% \times H1 1/2"	005.573.86
L98xD25% \times H1 1/2"	805.573.87



SÄLJAN Countertop
White/light gray stone effect

L74xD25% \times H1 1/2"	905.568.82
L98xD25% \times H1 1/2"	705.568.83

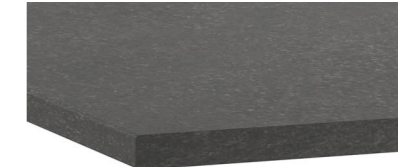

SÄLJAN Countertop
Dark gray stone effect

L74xD25% \times H1 1/2"	306.043.29
L98xD25% \times H1 1/2"	106.043.30
L74xD42 \times H1 1/2"	606.043.43



SÄLJAN Countertop
Oak effect

L74xD25% \times H1 1/2"	804.392.14
L98xD25% \times H1 1/2"	304.392.16
L74xD42 \times H1 1/2"	004.991.22



**Small island/
work bench**

Create a simple island from a couple of open cabinets with a durable laminate countertop that can withstand all the baking and preparing you can handle.

Pre-cut thick veneer wood countertops



Natural and durable, wood brings a warm feeling to your kitchen and makes each countertop unique. It ages beautifully and you just sand and treat it to keep it looking great.

Pre-cut thick veneer wood countertops have a layer of solid wood covering a particleboard core. They feel and look the same as solid wood. With this technique we can create new unique expressions, using less wood and reducing the impact on the environment. We pre-treat them with a hard wax oil, so you don't have to oil them when you get them or treat them at all until the surface starts to wear. They're available to take home today.



Natural and durable, wood brings a warm feeling to your kitchen and makes each countertop unique. With thick veneer, a 1/8" layer of wood covers a particleboard core to add excellent stability.

Thick veneer countertops come in the following crafted patterns: full plank, butcher-block, fine line and chevron.

The countertops are pre-treated with hard wax oil to create an easy-care surface for immediate use. Over time, it will only look better, gaining in character. They can be sanded and treated when needed, meaning that they will age gracefully.

Thick veneer countertops are available in pre-cut sizes that you take home today. They can be cut into the exact length you need and finished with the edge strip included in the package.



Ash

Ash is a blonde hard wood with a beautiful grain pattern. Ash is a tough and strong, yet elastic material with great resilience and finishing properties. It gets gradually darker with age. In its natural form it is heavy and gives a very solid feel.



Walnut

Walnut wood is relatively heavy, hard and resilient. The natural color light brown to dark chocolate brown adds warmth to your kitchen decor. Walnut gets lighter in color with age. It has a rich variation in color and a decorative, curved grain pattern.



Oak

Oak wood is exceedingly strong, heavy and durable. It is an attractive light color with a prominent grain. Its color ranges from light brown to a rich reddish-brown and it darkens beautifully with age.

Thick veneer wood countertops Walnut



The natural color and grain of wood adds warmth to your kitchen decor. Walnut gets lighter in color with age. It has a rich variation in color and a decorative, curved grain pattern.

They are all available to take home today.



BARKABODA Countertop
Thick veneer walnut

L74×D25%×H1½" 103.314.72
L98×D25%×H1½" 903.314.73



KARLBY Countertop
Thick veneer walnut

L74×D25%×H1½" 503.352.08
L98×D25%×H1½" 703.352.12



PINNARP Countertop
Thick veneer walnut

L74×D25%×H1½" 004.674.75
L98×D25%×H1½" 204.674.79



EKBACKEN Countertop
Brown walnut effect/laminate

L74×D25%×H1½" 604.764.86
L98×D25%×H1½" 004.429.89

Thick veneer wood countertops Oak



Oak is a very hard wood, making it a popular choice for countertops and interiors. Its color ranges from light brown to a rich reddish-brown and it darkens with age.

They are all available to take home today.



KARLBY Countertop
Thick veneer oak

L74×D25%×H1½" 703.352.07
L98×D25%×H1½" 903.352.11



MÖLLEKULLA Countertop
Thick veneer oak

L74×D25%×H1½" 003.011.35
L98×D25%×H1½" 803.011.36



SKOGSÅ Countertop
Thick veneer oak

L74×D25%×H1½" 203.829.94
L98×D25%×H1½" 903.829.95



VRENA Countertop
Thick veneer oak

L74×D25%×H1½" 304.371.56
L98×D25%×H1½" 004.371.53

Thick veneer wood countertops Ash



Ash is a blonde hard wood with a beautiful grain pattern. The variations in the color make each countertop unique and give it a distinctive natural look. It gets gradually darker with age.

They are all available to take home today.



PINNARP Countertop Thick veneer ash

L74×D25%×H1½" 703.723.13
L98×D25%×H1½" 503.723.14

Wood treatment oil



STOCKARYD Wood treatment oil
For indoor use.

17 oz 202.404.62

Wood protection



FENSJÖ Diffusion barrier

Prevent dishwasher steam/moisture damage to wood and wood veneer countertops. This plastic strip is easy to adhere to the underside of the countertop.

L31½×W3½" 006.135.42

Big advantages of a custom-made countertop

Your custom-made countertop is made to fit your kitchen layout perfectly, with the least number of seams. You can order the exact length and depth you need for your kitchen island or bar solution as well as cut-outs for your sink, faucet and cooktop.



How to buy a custom-made countertop

1

Material and color

Choose a color that makes the kitchen your own.

2

The countertop profiles

Choose the desired profile for the edges. Depending on the material you've chosen for your countertop, you have different options.

3

Choose your sink

Choose the sink you want and if you want it top mounted or under-mounted.

4

Take measurements

Then start to measure to see what size and shape of countertop you need. If you would like help with this, or with anything to do with measuring your kitchen, our measuring service can come to your home.

5

We're here to help

To design your custom-made countertop get help from an IKEA co-worker in the kitchen department at your local store.

6

Order

To order your custom-made countertop, please contact an IKEA co-worker in the kitchen department at your local store.

How to measure your countertop

Start by measuring your countertop from the corner where it attaches to the wall. Make sure to make your measurements alongside the wall and always start from the same point. When measuring the depth, start from the wall and measure out. Don't forget to add 1½" for an overhang too.

If you need to measure for a freestanding countertop (for a kitchen island for example), simply start from one end and add 1½" extra for an overhang.

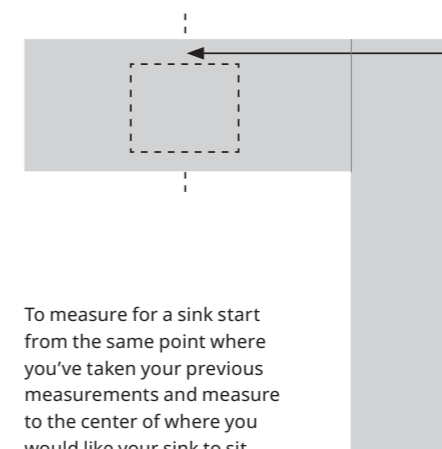
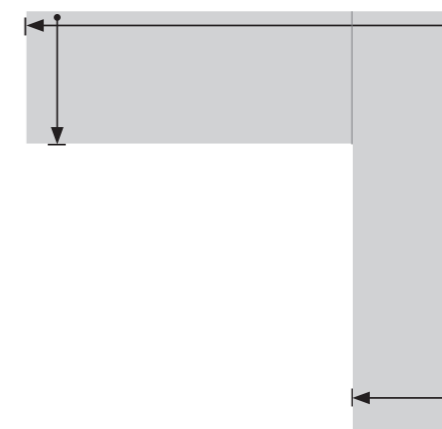

To measure for a sink start from the same point where you've taken your previous measurements and measure to the center of where you would like your sink to sit.

LOCKEBO glass composite custom-made countertops



When you choose a LOCKEBO glass composite custom countertop you get a work surface that's extremely durable as well as sustainable. It is made with at least 80% recycled materials. It's scratch, stain, and heat resistant and withstands heavy impacts. The special high tech process results in a beautiful, low maintenance, and sustainable material that is easy to keep clean. You can also order coordinating backsplashes to complement your countertop.

3cm thick glass composite countertops are available in five edge styles:

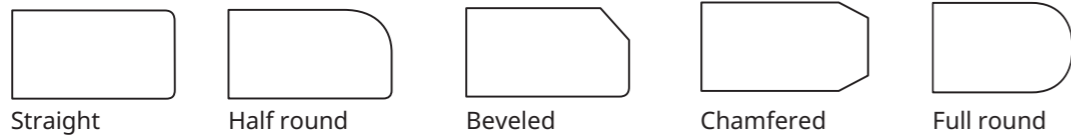

LOCKEBO Countertop
Light gray/white marble effect glass composite
3cm thick 206.168.08



LOCKEBO Countertop
Off-white brown/marble effect glass composite
3cm thick 706.168.20



LOCKEBO Countertop
Off-white gray marble effect glass composite
3cm thick 406.168.12



LOCKEBO Countertop
White lively marble effect glass composite
3cm thick 806.208.93



LOCKEBO Countertop
White marble effect glass composite
3cm thick 806.168.10



LOCKEBO Countertop
Black marble effect glass composite
3cm thick 406.208.90



LOCKEBO Countertop
Off-white gray/concrete effect glass composite
3cm thick 006.168.14



LOCKEBO Countertop
White/gray lively marble effect glass composite
3cm thick 306.168.17

Good to know
Clean using a soft cloth or sponge and warm water with a mild, non-abrasive detergent. Avoid using scouring products.



LOCKEBO Countertop
White/glass composite
3cm thick 306.208.95



LOCKEBO Countertop
White mineral effect glass composite
3cm thick 606.208.94



LOCKEBO Countertop
Off-white marble effect glass composite
3cm thick 006.208.92

Too new for photo



LOCKEBO Countertop
Gray marble glass effect glass composite
3cm thick 706.351.02



LOCKEBO Countertop
Gray stone effect glass composite
3cm thick 206.208.91

LOCKEBO Countertop
Black stone effect glass composite
3cm thick 606.208.89



Sinks

A busy place in the kitchen

The sink and the area around it is one of the busiest places in the kitchen. You use it for everything from preparing food and rinsing vegetables, to storing dirty dishes and cleaning up. To make the activities as easy as possible, choose a sink and sink accessories that match your needs and the way you work in the kitchen.

How to choose your sink

01

How much space have you allocated for the sink? Our sink cabinets are 24, 30 or 36" wide.

02

Think about how you prepare food, but also how you clean up. Do you have a dishwasher or do you wash the dishes by hand? Do you need one bowl, two bowls or a sink with drainboard?

03

Complete your sink with sink accessories that help you organize the area in and around the sink, both when you prepare food and when you clean up. **See pages 77, 101-107.**

25

We test our sinks to ensure they can withstand the demands of everyday life in the kitchen. That's why all our sinks come with a free 25-year limited warranty (except FYNDIG). Find out more on [page 112-113](#).



Our range of sinks

Single bowl sinks

If space is an issue, one single bowl is a good option. Plus, in a big single bowl you can easily wash large pots and pans. Combine with sink accessories to make the bowl as functional as possible. **See pages 79, 111-117.**

Double bowl sinks

Having two bowls is ideal if you have a lot going on at the same time. For example, if one of the bowls is piling up with dirty dishes, you can still rinse off vegetables and the like in the other.

1½ bowl sinks

A one and a half bowl sink gives you the same advantages as a double bowl sink, but in a smaller area.

Sinks with drainboard

A sink with a drainboard is ideal for drying dishes as the sloping surface make excess water flow back into the bowl. Our sink with drainboard is reversible, so you can choose if you want the drainboard to the left or to the right.

Sink cabinet sizes

24"

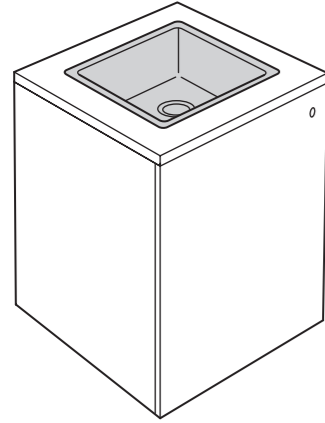

30"

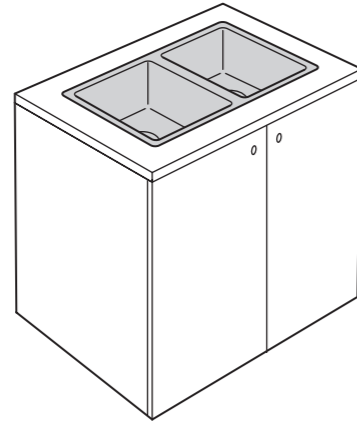

36"

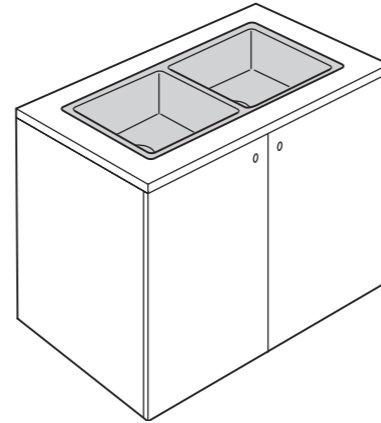

Fits 24" cabinets



FYNDIG Inset sink, 1-bowl

May be completed with GRUNDVATTNET sink accessories for effective use of space of the sink. LILLVIKEN strainer is included, but packaged separately. Requires installation. W18½×D15¾×H5½".

Stainless steel 691.580.07



BOHOLMEN Inset sink, 1-bowl

Can be undermounted. May be completed with GRUNDVATTNET sink accessories for effective use of space of the sink. LILLVIKEN strainer is included, but packaged separately. Requires installation. Ø17¾×H5½".

Stainless steel 891.574.98



VATTUDALEN Inset sink, 1-bowl with drainboard

Reversible; can be used with the drainboard to the right or left. May be completed with GRUNDVATTNET sink accessories for effective use of space of the sink. LILLVIKEN strainer is included, but packaged separately. Requires installation. W27½×D18½×H7½".

Stainless steel 891.581.72



VRESJÖN Inset sink, 1-bowl

Can be undermounted. LILLVIKEN strainer and LILLVIKEN lid included, but packaged separately. Requires installation. L14½×D17¾".

Stainless steel 294.257.10



VRESJÖN Inset sink, 1-bowl

Can be undermounted. LILLVIKEN strainer and LILLVIKEN lid included, but packaged separately. Requires installation. L21¼×D17¾".

Stainless steel 694.257.27



TALLSJÖN Apron front sink, 1-bowl

Two additional holes are marked underneath as an option for faucets needing multiple holes, a sprayer or soap dispenser. LILLVIKEN strainer and LILLVIKEN lid included, but packaged separately. Quartz composite. Requires installation. L23¾×D26½×H7¾".

Dark gray 894.913.54

Fits 24" cabinets



HAVSEN Apron front sink, 1-bowl

Ceramic sinks are kiln-fired which makes each one unique, therefore the size may vary slightly from the measurements given. Fits countertop with a minimum thickness of 1". LILLVIKEN strainer is included but packaged separately. Ceramic. Requires installation. W25×D18¾×H7¾".

White 792.537.25



HAVSEN Inset sink, 1-bowl

Ceramic sinks are kiln-fired which makes each one unique, therefore the size may vary slightly from the measurements given. LILLVIKEN strainer is included, but packaged separately. Ceramic. Requires installation. W21×D19×H7¾".

White 192.537.28



LÅNGUDDEN Inset sink, 1-bowl

Has a pre-drilled hole for a kitchen faucet. May be completed with GRUNDVATTNET sink accessories for effective use of space of the sink. LILLVIKEN strainer is included, but packaged separately. Requires installation. W22×D20¾×H7¾".

Stainless steel 891.574.84



KILSVIKEN Inset sink, 1-bowl

Can be undermounted. The natural color variations of the quartz make each KILSVIKEN sink one of a kind bringing a unique look to your kitchen. The surface is durable and resistant to scratches, heat, stains and impacts. LILLVIKEN strainer and LILLVIKEN lid are included, but packaged separately. Quartz composite. Requires installation. W14½×D18½×H7¾".

Black 993.370.22



KILSVIKEN Inset sink, 1-bowl

Can be undermounted. The natural color variations of the quartz make each KILSVIKEN sink one of a kind bringing a unique look to your kitchen. The surface is durable and resistant to scratches, heat, stains and impacts. LILLVIKEN strainer and LILLVIKEN lid are included but packaged separately. Quartz composite. Requires installation. W22×D18½×H7¾".

Black 393.370.15



KILSVIKEN Inset sink, 1-bowl

Can be undermounted. The natural color variations of the quartz make each KILSVIKEN sink one of a kind bringing a unique look to your kitchen. The surface is durable and resistant to scratches, heat, stains and impacts. LILLVIKEN strainer and LILLVIKEN lid are included but packaged separately. Quartz composite. Requires installation. W22×D18½×H7¾".

White 795.799.60



Fits 30" cabinets



HILLESJÖN Inset sink, 1½-bowls

Can be undermounted. May be completed with GRUNDTVATTNET sink accessories for effective use of sink space. LILLVIKEN strainer is included but packaged separately. Requires installation. W22¾×D18½×H7½".

Stainless steel 991.407.04



HILLESJÖN Inset sink, 1½-bowls

Can be undermounted. May be completed with GRUNDTVATTNET sink accessories for effective use of space of the sink. LILLVIKEN strainer is included but packaged separately. Requires installation. W29½×D18½×H7½".

Stainless steel 091.407.08



HILLESJÖN Inset sink, 2 bowls

Can be undermounted. May be completed with GRUNDTVATTNET sink accessories for effective use of space of the sink. LILLVIKEN strainer is included but packaged separately. Requires installation. W29½×D18½×H7½".

Stainless steel 391.574.91



KILSVIKEN Inset sink, 1-bowl

Can be undermounted. The natural color variations of the quartz make each KILSVIKEN sink one of a kind bringing a unique look to your kitchen. The surface is durable and resistant to scratches, heat, stains and impacts. LILLVIKEN strainer and LILLVIKEN lid are included but packaged separately. Requires installation. W28¾×D18½×H7½".

Quartz/acrylic black 993.370.17



KILSVIKEN Inset sink, 1-bowl

Can be undermounted. The natural color variations of the quartz make each KILSVIKEN sink one of a kind bringing a unique look to your kitchen. The surface is durable and resistant to scratches, heat, stains and impacts. LILLVIKEN strainer and LILLVIKEN lid are included but packaged separately. Requires installation. W28¾×D18½×H7½".

Quartz/white 495.903.94



LÅNGUDDEN Inset sink, 2-bowls

Has a pre-drilled hole for a kitchen faucet. May be completed with GRUNDTVATTNET sink accessories for effective use of space of the sink. LILLVIKEN strainer is included but packaged separately. Requires installation. W29½×D20¾×H7½".

Stainless steel 991.574.88



TALLSJÖN Apron front sink, 1-bowl

Two additional holes are marked underneath as an option for faucets needing multiple holes, a sprayer or soap dispenser. LILLVIKEN strainer and LILLVIKEN lid are included but packaged separately. Quartz composite. Requires installation. W29¾×D26¼×H7¾".

Dark gray 694.913.69



VRESJÖN Inset sink, 1-bowl

Can be undermounted. LILLVIKEN strainer and LILLVIKEN lid are included but packaged separately. Requires installation. W28¾×D17¾".

Stainless steel 994.257.35



BOVIGGEN Apron front sink, 1-bowl

BOVIGGEN ceramic undermount sink with an apron front has large bowl that swallows both oven trays and big pots. A practical and decorative solution that goes just as well in a traditional kitchen as in a modern one. Fits countertop with a minimum thickness of 1". LILLVIKEN strainer is included but packaged separately. Ceramic. Requires installation. W34¼×D19×H9¾".

White 694.431.04

Sink accessories

Our sink accessories support all activities in and around the sink, helping you when preparing food and washing up. Plus, they help you to save both water and space, too.



LILLVIKEN Sink strainer

Strainer and strainer basket

Stainless steel 503.254.26



LILLVIKEN Lid Attaches via a magnet to all sink bowls with LILLVIKEN water-trap and can be used as a handle for lifting the basket. The lid creates a flat surface at the bottom of the sink and prevents food waste from getting into the basket, making the sink easy to keep clean.

Stainless steel 203.178.52



NORRSJÖN Colander The colander is designed to rest steadily on the edges of the bowl. You can use it as a colander to rinse vegetables and salad or drain pasta. Fits on the bowl of all NORRSJÖN sinks. L16½×W7½×H3½".

Stainless steel 003.397.13



NORRSJÖN Cutting board You can place the chopping board over the sink to get more space on the countertop and to hide dirty dishes. Fits over the bowl of NORRSJÖN sinks. L17¼×W16½".

Solid oak 403.397.11

Fits 36" cabinets

Kitchen faucets

Saving water at every step

Earth may be covered in a lot of water, but very little of it is drinkable and even less is accessible. No organism can survive without it, and no new water is created. It's constantly recycled, but our freshwater supply is overused; not evenly distributed; and impacted by pollution, contamination and climate change. That's why we equip all our kitchen faucets with a water saving aerator that reduces water use up to 40%—while maintaining the same pressure. We didn't invent aerators, but think they are an important example of how we can work together to save water for everyone's benefit.

10

All IKEA kitchen faucets come with a free 10-year limited warranty. Find out more on [pages 122-123](#).



Functions



Kitchen faucets with high spout

The high spout makes it easier to wash dishes, including large pots.

DELSJÖN Kitchen faucet*

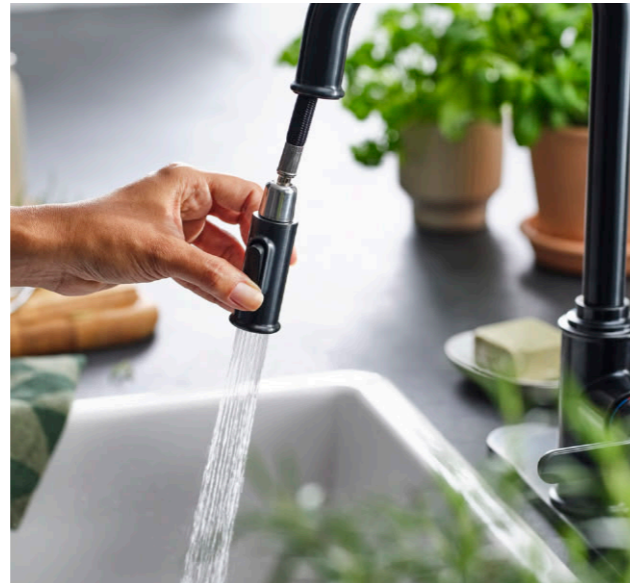

Kitchen faucets with pull-down spout

Rinsing dishes is easier with the pull-out spout. A counterweight makes the hose easily retract back into the kitchen faucet.

TAKSJÖN Kitchen faucet with pull-down spout



Kitchen faucets with low spout

Kitchen faucets with low spouts always have the handle on top, and are ideal for small single bowl sinks.

LAGAN Kitchen faucet*



Kitchen faucet pull-out with sprayer

The dual function spray head switches from between aerated stream and full spray for all your rinsing needs.

SALLSJÖN Kitchen faucet with pull-out spout
Includes optional deck plate*

Kitchen faucets with high spout



EDSVIK Dual control kitchen faucet H12³/₄". This faucet is for use on high pressure water systems. Tested to work with a max. pressure of 10 bar (1000 kPa). Recommended working pressure range is 1.0–5.0 bar (100 kPa–500 kPa). Swivel spout is preset to 360°. Also available with pull-out spout. Requires installation.

Chrome-plated 304.955.23



GLITTRAN Kitchen faucet H11". Swivel spout 360°. Requires installation.

Brass-color 804.686.83



ÄLMAREN Kitchen faucet H14¹/₄". Swivel spout is preset to 360° but can be changed to 120°. Also available with pull-out spout. Requires installation.

Stainless steel-color 503.416.43
Black 206.052.06



DELSJÖN Kitchen faucet H14¹/₄". Swivel spout is preset to 360° but can be changed to 120°. Requires installation.

Brass-color 104.780.44

Brushed black metal 504.888.09

Kitchen faucets with low spout



LAGAN Kitchen faucet H6¹/₄". Swivel spout: 360°. Requires installation.

Chrome-plated 700.850.29



GLYPEN Kitchen faucet H10¹/₄". Swivel spout is preset to 360° but can be changed to 90° or 120°. Requires installation.

Stainless steel-color 704.423.92



MACKSJÖN Kitchen faucet H8³/₈". Swivel spout 120°. The spout can be pulled out approx. 12". Dual-function spray head switches between aerated stream and full spray. Includes optional deck plate. Requires installation.

Stainless steel-color 406.013.73

Kitchen faucets with pull-out spout



ÄLMAREN Kitchen faucet with pull-out spout H14¾". Swivel spout 120°. Also available without pull-out spout. Requires installation.

Stainless steel-color	803.416.51
Black	406.052.05

Kitchen faucets with handspray



New

MAJSJÖN pull out Kitchen faucet with handspray. H18½". Swivel spout 120°. Requires installation.

Stainless steel-color	606.106.54
-----------------------	------------



New

SALLSJÖN pull down kitchen faucet with handspray H18". Swivel spout is preset to 360° but can be changed to 120°. Requires installation.

Black	106.106.56
-------	------------



New

SALLSJÖN pull down kitchen faucet with handspray H18". Swivel spout is preset to 360° but can be changed to 120°. Requires installation.

Stainless steel-color	906.106.38
-----------------------	------------



New

SALLSJÖN pull out Kitchen faucet with handspray. H18½". Swivel spout 360°. Requires installation.

Stainless steel-color	406.106.26
-----------------------	------------



New

TAKSJÖN pull down kitchen faucet handspray H18". Swivel spout is preset to 360° but can be changed to 120°. Requires installation.

Stainless steel-color	106.105.00
-----------------------	------------



New

TAKSJÖN pull out kitchen faucet with handspray H18". Swivel spout is preset to 360° but can be changed to 120°. Requires installation.

Black	706.092.59
-------	------------



MACKSJÖN Kitchen faucet with pull-down spray H16½". Swivel spout 360°. The spout can be pulled out approx. 12". Dual-function spray head switches between aerated stream and full spray. Includes optional cover plate. Requires installation.

Stainless steel-color	806.008.33
Black	406.013.68
Brass-color	606.013.72



Lighting for ENHET

SKYDRAG series



SKYDRAG lighting kit is designed for the ENHET series, perfect both as countertop lighting and to create ambience in the kitchen. With the TRÅDFRI driver and the wireless dimmer, you can easily turn on, off and dim your lighting.



SKYDRAG LED countertop/wardrobe lighting strip with sensor, dimmable.

18"	
White	004.395.95
Anthracite	904.396.09
24"	
White	404.396.02
Anthracite	104.791.66

Cords, LED drivers and Dimmer



ANSLUTA Power supply cord This cord is the power source for TRÅDFRI LED drivers. With this cord, you can connect up to 10 LED drivers of connected lamps to the power grid — and turn on, turn off and dim all of them at the same time with TRÅDFRI wireless dimmer.

L11'6".	301.214.11
---------	------------



ANSLUTA Intermediate connection cord. Can be used as a direct connection between TRÅDFRI LED drivers, e.g. between two sections of wall cabinets, with one single connection to the mains with ANSLUTA power supply cord.

L28"	401.199.26
L79"	601.199.25



ANSLUTA LED driver with power cord 19W Use this driver if you want turn all connected light sources on and off with a single switch. *Does not work with TRÅDFRI dimmer, STYRBAR remote control or DIRIGERA hub.

L11'6"	904.058.45
--------	------------



TRÅDFRI LED driver Must be completed with ANSLUTA power supply cord, sold separately. Can be used with STYRBAR remote control and DIRIGERA hub.

Holds 3 lights or max 10W	103.561.89
Holds 6 lights or max 30W	603.426.61



RODRET Wireless dimmer/power switch Use the wireless dimmer to dim, turn on/off up to 10 light sources - all will behave in the same way. You can dim your lighting wirelessly and easily adapt the lighting based on activity. Requires 1-AAA battery, sold separately.

White	805.598.00
-------	------------



LADDA Rechargeable batteries Reduce waste and save money by recharging your batteries.

AAA 750mAh HR03 1.2V	905.098.19	4pk
AA 1900mAh HR06 1.2V	005.098.14	4pk
AA 2450mAh HR06 1.2V	505.046.92	4pk



STENKOL Battery charger Four individual charging channels allows you to charge one or up to four batteries at a time and to mix both AA and AAA batteries. The charger will stop charging when the batteries are fully charged.

Gray-green	505.065.25
------------	------------

Complete your combination with lighting

How to build

SKYDRAG LED cabinet lighting is easy to install by yourself.

- When you start building your system, you must first consider the widths of your cabinets. For example, for a cabinet with a width of 23%", you'll need the SKYDRAG lighting strip 23% too.
- Choose the number of SKYDRAG lighting strips that you need.
- Add the TRÅDFRI driver. You can connect up to three or nine units to the driver, as long as the total wattage does not exceed 10W or 30W. TRÅDFRI drivers need to be connected to the plug with an ANSLUTA power cable.

- Add TRÅDFRI wireless dimmer or STYRBAR remote control to dim your lighting. Pair the dimmer to the TRÅDFRI driver and the entire combination will dim at the same time.
- Add the DIRIGERA hub to control SKYDRAG connected lighting from the IKEA Home smart app in different ways together with other TRÅDFRI lighting in your home.

ENHET open frames



On top of frame



Under shelf

ENHET closed solutions



Under wall cabinet

KNOXHULT kitchen

A kitchen made easy, with great value for your money

KNOXHULT kitchens make it easier than you think to create a kitchen to love.

The selection of cabinets in different shapes and sizes help create a practical kitchen catered to your varied needs. Add to this, they come with pre-coordinated fronts and countertops, so all you have to do is combine the cabinets to suit your space and preferences. When you're happy with the result, personalize it with your favorite sink, faucet, appliances, knobs/handles and lighting and you're ready to cook.

On the inside, you have great storage possibilities for things both large and small. To create order and make efficient use of space inside cabinets and drawers in your KNOXHULT kitchen, add organizers, so you can spend less time searching and more time cooking.

KNOXHULT kitchen cabinets offer a simple path to a great kitchen that will be your companion for years to come.

5

The KNOXHULT kitchen has a free 5-year limited warranty. Find out more on [page 112](#).



KNOXHULT front and countertop expressions



White front with oak effect countertop

White fronts paired with oak effect countertop gives the kitchen a fresh and timeless expression that is easy to like.



Dark gray front with white marble effect countertop

Dark gray fronts combined with a white marble effect countertop brings a modern air to your kitchen and makes it feel warm and inviting.



Oak effect front with white marble effect countertop

The oak effect fronts paired with a white marble effect countertop creates a vibrant expression that adds warmth to your kitchen.



White framed front with oak effect countertop

Timeless white framed fronts combined with oak effect countertop creates a welcoming kitchen with a traditional appeal.

Base cabinets



New

KNOXHULT Case cabinet with drawers W15×D24×H36". This base cabinet with three drawers lets you organize your kitchen essentials, using space wisely and making things easy to find. The ¾ drawer extension provides a good overview and easy access to the content. The laminate countertop is durable and easy to maintain. With a little care, it will look good as new for many years. The cabinet and drawer fronts are covered with melamine, providing a scratch-resistant surface that is easy to wipe clean.

White	403.722.63
Dark gray	106.040.09
Oak effect	606.040.02
White frame	106.039.91



New

KNOXHULT Base cabinet with doors and drawer W48×D24×H36". This base cabinet can be fitted with a sink and faucet and it has convenient countertop space giving you room to prepare food as well as easy access to cookware in the cabinet below. With both a drawer and adjustable shelves, you can organize the space inside the cabinets according to what is being stored. The cabinet can be assembled in two ways, with the cabinet for the sink and faucet positioned either to the left or right, depending on your needs. The laminate countertop is durable and easy to maintain. With a little care, it will look good as new for many years. Cabinets and fronts are covered with melamine providing a scratch-resistant surface that is easy to wipe clean.

White	603.722.62
Dark gray	506.040.07
Oak effect	006.040.00
White frame	506.039.89

New



KNOXHULT Base cabinet with doors and drawers W72×D24×H36". This base cabinet can be fitted with a sink and faucet and it has convenient countertop space giving you room to prepare food as well as easy access to cookware in the cabinets below. With both a drawer and adjustable shelves, you can organize the space inside cabinets according to what is being stored. The cabinet can be assembled in three ways, with the cabinet for the sink and faucet positioned either to the left, right or in the middle, depending on your needs. The laminate countertop is durable and easy to maintain. With a little care, it will look good as new for many years. Cabinets and fronts are covered with melamine providing a scratch-resistant surface that is easy to wipe clean.

White	003.722.60
Dark gray	306.040.08
Oak effect	806.040.01
White frame	306.039.90



New

KNOXHULT Corner base cabinet W44×D24×H36". This base cabinet makes good use of corner spaces, providing extra depth for working and roomy storage for larger pots and pans. The included shelf is adjustable and allows you to optimize the storage space inside the cabinet. The laminate countertop is durable and easy to maintain. With a little care, it will look good as new for many years. The cabinet and front are covered with melamine, providing a scratch-resistant surface that is easy to wipe clean.

White	703.722.71
Dark gray	906.040.10
Oak effect	406.040.03
White frame	906.039.92

Wall cabinets



KNOXHULT Wall cabinet with door W15×D12×H30". This wall cabinet is ideal for creating additional storage space in the kitchen, providing easy access to often used items. The adjustable shelf allow for efficient use of space inside the cabinet. The cabinet and front are covered with melamine, providing a scratch-resistant surface that is easy to wipe clean. The door can be mounted to open left or right.

White	903.722.65
Dark gray	506.040.12
Oak effect	906.040.05
White frame	506.039.94



KNOXHULT Wall cabinet with door W24×D12×H30". This wall cabinet is ideal for creating additional storage space in the kitchen, providing easy access to often used items. The adjustable shelf allows for efficient use of space inside the cabinet. The cabinet and front are covered with melamine, providing a scratch-resistant surface that is easy to wipe clean. The door can be mounted to open left or right.

White	503.722.67
Dark gray	306.040.13
Oak effect	706.040.06
White frame	206.039.95



KNOXHULT Wall cabinet with doors W30×D12×H12½". This wall cabinet offers well-needed storage without taking up too much space. Can be completed with a range hood. The cabinet and fronts are covered with melamine providing a scratch-resistant surface that is easy to wipe clean.

White	905.002.77
Dark gray	706.040.11
Oak effect	206.040.04
White frame	706.039.93

KNOXHULT Wall cabinet with sliding doors W48×D11½×H12½". This wall cabinet with sliding glass doors makes good use of wall space. You get functional storage with a good overview, and the possibility to put your favorite objects on display. Adjustable glass shelves allow you to customize your storage. The cabinet is covered with melamine, providing a scratch-resistant surface that is easy to wipe clean.

White	406.040.22
Oak effect	206.240.97



ÖNNERUP KITCHENETTE

Warm and traditional

ÖNNERUP serves as a beautiful, functional hutch cabinet that easily complements your kitchen or dining area. Use the open shelves to show off the things you want to or hide clutter in the drawers or behind the doors.



ÖNNERUP Kitchenette serves as a beautiful, functional hutch cabinet that easily complements your kitchen or dining area. Use the open shelves to show off the things you want to or hide clutter in the drawers or behind the doors. W51 $\frac{1}{2}$ "x D25 $\frac{1}{4}$ "x H86 $\frac{1}{4}$ ". Includes: off-white painted kitchen cabinet frame, warm oak effect countertop, four shelves, two doors, and white drawers. Knobs and handles sold separately.

White 005.002.86

ÖNNERUP Kitchenette Shown on right page
Save space with the ÖNNERUP kitchenette. Perfect for any small space kitchen needs, such as in-law suite or basement apartment. 994.944.27

- Includes: off-white painted kitchen cabinet frame, warm oak effect countertop, four shelves, two doors, and three drawers. Also included, but sold separately: FYNDIG kitchen sink, GLYPEN kitchen faucet, LILLVIKEN sink strainer with stopper, and ENERYDA knobs. Complete with your choice of TILLREDA portable cooktop, TILLREDA microwave oven, LAGAN or TILLREDA refrigerators, HÅLLBAR waste management, and VARIERA/UPPDATERA organizers. Sold separately.

10

The ÖNNERUP kitchenette has a 10-year limited warranty. Find out more on page 112.



ÄSPINGE KITCHENETTE

Flexible and affordable

ÄSPINGE kitchenette doesn't compromise on quality, function or personal expression. Clever storage solutions and a blend of materials make this small-size unit into a big show of who you are.



ÄSPINGE Kitchenette W47¼×D23¾×H79¾". Includes: kitchen frame, hanging wall shelves, backsplash with shelf, countertop, doors, drawer boxes, two cutlery trays, 12 hooks, two handles, legs, hinges and hardware. FYNDIG sink and LAGAN faucet included, packaged separately. Complete with your choice of TILLREDA portable cooktop, LAGAN or TILLREDA refrigerator, TILLREDA microwave oven, HÄLLBAR waste management and VARIERA/UPPDATERA organizers, sold separately.

Black/ash 994.782.67



TILLREDA Portable induction cooktop W10½×D12¾×H2½".

Black 104.935.20



TILLREDA Microwave oven 676 oz. W17¼×D13¾×H10½".

White 404.934.20

Black 905.464.78

Key Features:

- No need to custom-cut as the countertop comes with pre-cut holes for FYNDIG sink 1-bowl 18¼×15¾" and LAGAN faucet. Sink and faucet sold separately.
- Three drawer boxes with felt underneath for smooth opening and closing.
- The black metal cabinet door has an adjustable wire storage on the inside that can be used to store flatter items like lids and cutting boards. This door is always hung on the left side of the kitchen.
- The backsplash has a shallow shelf where you can display cherished knick-knacks or store spices, fresh herbs, oil and vinegar keeping them close at hand while cooking.
- The two hanging open wall shelves can be positioned left, right or center and are perfect for putting your favorite items on display.
- The ash-effect door coordinates with the hanging wall shelves and drawer boxes made of the same material. It is always hung on the right-hand-side under the sink.



SUNNERSTA KITCHENETTE

Flexible and affordable

With SUNNERSTA kitchenette you can create an open and welcoming kitchen even if space is limited. It's also great for dorm rooms and guest houses. Use the hooks and containers to keep track of utensils, and use the cart as a utility surface

when there's a lot going on in the kitchen. By adding our TILLREDA portable induction cooktop and compact fridge, you'll have everything you need. This affordable and flexible kitchen is easy to buy, get home, install and move to new places.



SUNNERSTA Kitchenette
LAGAN faucet and LILLVIKEN strainer and water trap included in the price, but packaged separately.
W44 $\frac{1}{2}$ "x D22" x H54 $\frac{3}{4}$ ".
591.396.89



SUNNERSTA Rail with 4 hooks and 2 containers
White. L23 $\frac{3}{4}$ "x D5 $\frac{1}{2}$ " x H5 $\frac{1}{2}$ ".
404.545.60



SUNNERSTA Paper towel holder White. W12" x D5" x H2".
805.000.08



SUNNERSTA Container
White. Fits SUNNERSTA rail, cart and mini-kitchen.
W4 $\frac{3}{4}$ " x D4 $\frac{3}{4}$ " x H5 $\frac{1}{2}$ ".
503.037.35



LAGAN Kitchen faucet
Single lever. Swivel sprout 360°. Chrome-plated. H6 $\frac{1}{4}$ ".
700.850.29



TILLREDA Portable induction cooktop
W10 $\frac{5}{8}$ " x D12 $\frac{3}{4}$ " x H2 $\frac{1}{2}$ ".
Black
104.935.20



TILLREDA Microwave oven
676 oz. W17 $\frac{1}{4}$ " x D13 $\frac{3}{8}$ " x H10 $\frac{1}{8}$ ".
White 404.934.20
Black 905.464.78



TILLREDA Refrigerator
2 cu.ft. W18 $\frac{5}{8}$ " x D17 $\frac{3}{8}$ " x H19 $\frac{3}{8}$ ".
White
204.970.23



Kitchen islands, carts, stools and accessories

A kitchen easy to live in

Your kitchen isn't fully functional until everything in it has found a place of its own. With smart organizers and accessories, you'll find what you need, when you need it.

Utilize the full area in the kitchen, even the walls. With smart wall storage often-used items can be close at hand, at the same time you free up workspace.

Your best kitchen friends

Our carts and islands boost your storage space and kitchen functionality while adding a social focal point in your kitchen at the same time.

The sink area is a busy place. We have accessories with multiple purposes that can help you utilize the area in and around the sink, supporting the workflow both when preparing food and washing up.



Kitchen islands and sideboards

Boost your storage space and kitchen functionality while adding a social focal point in your kitchen at the same time. A kitchen island or sideboard is great for many things.



TORNVIKEN Kitchen island

W28¾×D20½×H35¾".

Off-white/oak 003.933.71



VADHOLMA Kitchen island

W31¼×D24¾×H35¾".

Black/oak 403.661.15



TORNVIKEN Kitchen island

W49¾×D30¾×H35¾".

Off-white/oak 403.916.57

Gray/oak 803.933.72



VADHOLMA Kitchen island

W49×D31¼×H35¾".

Black/oak 203.591.54



RIMFORSA Work bench

W47¼×D25¾×H36¼".

Stainless steel/bamboo 603.994.12



VADHOLMA Kitchen island with rack

W49×D31¼×H88¾".

Black/oak 592.762.28



RESARÖ Mobile drop-leaf table with storage

W25¼×L16¾/24¾/48¾×H35¾". This mobile drop-leaf table is a space-saving, multi-functional companion that comes in handy for dining, studying, preparing food or serving snacks while socializing. Storage keeps essentials nearby.

Pine 205.333.37



Carts

A cart is a quick, easy and affordable solution giving you more flexible storage space.



BEKVÄM Cart W19¾×D22¾×H33½". Provides mobile extra storage, utility and work space. Solid wood is a durable natural material that you can sand and treat the surface as needed.

Birch 702.403.51



LOSHULT Cart W15×D15×H32¼". Helps keep smaller items organized and within reach in the kitchen, office, hobby room or wherever you could use some extra storage. Simple, straightforward design with a thin layer of transparent lacquer. Keep it the way it is or paint it in your favorite color to add a personal touch.

Pine 405.762.79



KUNGSFORS Cart W23¾×D15¾×H35¾". The top part of the kitchen cart is loose and can be used separately as a tray. Lockable casters for high stability. Stainless steel is very easy to clean thanks to its smooth, non-porous and hard surface.

Stainless steel 803.349.24



GROERYD Cart W28¾×D14¾×H31½". Lockable casters for high stability. Smooth tempered glass surface makes it easy to clean.

Bronze-color 304.989.46



FÖRHÖJA Cart W39¾×D16¾×H35¾". You can quickly view and access what's inside because the drawers can be pulled out from both sides. Open storage with space for 9 bottles on each shelf. Solid wood is a natural material that is easy to repair, refinish and change whenever you like.

Birch 800.359.20

Birch/white 804.867.24

Carts and stools

A cart is a quick, easy and affordable solution giving you more flexible storage space.

RÅSKOG Cart Perfect for use in your kitchen, bathroom or where you need some extra storage space. The sturdy construction and four casters make it easy to move wherever you like. The adjustable middle section is easy to move to adapt to different storage needs. Stands evenly on uneven floors as the casters are adjustable. Lockable casters.



W13¾×D17¾×H30¾"

White	305.867.83
Black	405.821.81
Gray-blue	105.867.84



W11×D15×H24"

White	005.867.89
Gray-green	505.917.69
Beige yellow	905.917.67



NORRÅVA Lid This bamboo lid is designed for a perfect fit on the top tier of RÅSKOG cart, adding a warm touch whilst hiding cluttering objects like kitchen utensils, desk accessories, keys and chargers.

W12¼×L16½"	005.428.61
W10¼×L14¼"	505.917.74



NISSAFORS Cart Use as an extra work area in the kitchen or bathroom, as practical storage in the hall or as a different bedside table in your bedroom. W19¾×D11¾×H32¾".

White	404.657.33
Black	203.997.77
Beige	405.858.01
Light green	106.067.82



JUTTERSBO Cart Indoor/outdoor use. Perfect for use in your kitchen, bathroom or where you need some extra storage space. The wheels and a handle on top make it easy to move to wherever you need it. Ø14¾", H33¾".

Gray-green	404.989.41
------------	------------



SUNNERTSA Storage unit This slim unit is sturdy and robust and provides extra storage in any room of the home. Must be secured to the wall for a safe installation. W15×L22×H38¾".

White	705.002.78
-------	------------



BEKVÅM Stepstool Max load 220 lbs. W16¾×D15¾×H19¾".

White	406.110.32
Rubberwood	506.110.22



BEKVÅM Stepladder, 3 steps W17¾×H24¾".

Black	304.846.71
Beech	504.846.70

Rails and accessories

Our selection of kitchen helpers gives you more work and storage space without the expense of a remodel.

SUNNERSTA series



SUNNERSTA Rail with four hooks/two containers
L23¾×D5½×H5½".

White	404.545.60
-------	------------



SUNNERSTA Drill-free adjustable rack
W18×H17¼-25¾".

White	204.409.51
-------	------------



SUNNERSTA Container 4¾×6¾".

White	503.037.35
Pale green	005.561.79



SUNNERSTA Hooks

403.037.26	5pk
------------	-----



SUNNERSTA Shelf

L9¾×D5½×H2"	904.439.27
-------------	------------



SUNNERSTA Shelf/dish drainer

L14¾×D5¾"	304.439.30
-----------	------------



SUNNERSTA Paper towel holder

L11"	805.000.08
------	------------

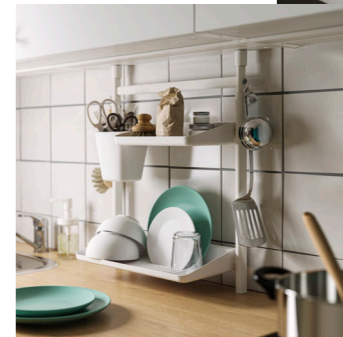

PÅLYCKE series

PÅLYCKE Clip-on basket



W14¾×D10¼×H5½"	005.344.32
----------------	------------



W8¾×D10¼×H7½"	805.344.33
---------------	------------



PÅLYCKE Clip-on hook rack

White	805.411.55
-------	------------



PÅLYCKE Clip-on multi-purpose rack

White	905.344.37
-------	------------



Rails and accessories

NEREBY series



NEREBY Container

Natural 904.290.97



NEREBY Wall shelf L15¾×D4¾×H3⅞".

Birch 904.659.24



NEREBY Rail Birch

L15¾" 004.673.00

L23½" 904.763.43



NEREBY S-hooks H3¾".

White 204.763.51 **5pk**

HULTARP series



HULTARP Container W5½×D6¼×H4¾".

Black 304.444.54

Black/mesh 704.628.27

Blue/nickel-plated 805.887.13

White/brass-color polished 104.628.30



HULTARP Container W12¼×D6¼×H4¾".

Black/mesh 204.488.34



HULTARP Dish drainer L11¾×W15¼×H14¾".

Black 604.487.66



HULTARP Hooks H2¾".

Black 104.444.45 **5pk**

Polished/brass-color 104.487.78 **5pk**



HULTARP Magnet knife rack L15".

Black 804.444.42



HULTARP Rail

L23½"

Black 004.487.69

Polished/brass-color 504.487.76



L31½"

Black 204.487.73

Polished/brass-color 304.487.77



HULTARP Papertowel holder W6×D6×H7".

Black 604.444.38



BEKVÄM Spice rack W15¾×D3⅞×H3½".

Aspen 204.871.75



Rails and accessories

Our selection of kitchen helpers gives you more work and storage space without the expense of a remodel.

KUNGSFORS series



KUNGSFORS Net bags

Natural 203.728.34 **set of 2**



KUNGSFORS Container Ø4¾, H10¾"

Stainless steel 003.349.18



KUNGSFORS Container W9½×D4¾×H10¾"

Stainless steel 603.349.20



KUNGSFORS Dish drainer W23½×D11¾×H4"

Stainless steel 403.712.25



KUNGSFORS Rail Stainless steel.

W22" 403.349.16



KUNGSFORS S-hooks Stainless steel.

H2¼" 203.349.22 **5pk**



KUNGSFORS Magnet knife rack Stainless steel.

W22" 403.349.21



KUNGSFORS Magnetic clips Stainless steel.

H3¾" 003.349.23 **3pk**



KUNGSFORS Wall grid W22×H10½"

Stainless steel 803.349.19



KUNGSFORS Shelf W23¾×D11¾"

Ash 903.712.23

Stainless steel 503.349.25



KUNGSFORS Suspension rail, L31½"

Stainless steel 803.348.58

KUNGSFORS combinations



KUNGSFORS Suspension rail with shelf/ wall grid W25¼×D12¾×H31½"

A stainless steel combination which includes two shelves that allow you to see what is on the shelf from underneath. On the wall grid you can create more storage space by hanging utensils using the S-hooks or containers in this series.

Stainless steel 192.543.32



KUNGSFORS Suspension rail with shelf/ magnet knife rack W25¼×D12¾×H31½"

This combination comprises three shelves in ash that help you store what you need, while providing a mixture of materials that feel warm and professional in the kitchen. The magnetic knife rack makes it easy to see and reach all your different knives when cooking.

Ash/stainless steel 392.543.26



KUNGSFORS Cart W23¾×D15¼×H35¾"

The top part of the kitchen cart is loose and can be used separately as a tray. Lockable casters for high stability. Stainless steel is very easy to clean thanks to its smooth, non-porous and hard surface.

Stainless steel 803.349.24



Sink accessories

Our sink accessories support all activities in and around the sink, helping you when preparing food and washing up. Plus, they help you to save both water and space.



LILLHAVET Multifunctional dish rack L18¾×W6¾".
The soft coating prevents rusting and will outlast many years and washes.

Anthracite 804.612.76



LILLHAVET Colander This over-the-sink colander is perfect to use as a strainer for washing fruit and vegetables, as a dish drainer or simply to hold sink bowl accessories. W19×D7¾×H4".

Anthracite 505.034.66

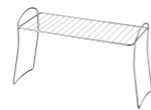

VÄLVÄRDAD Dish drying shelf
L12½×W5×H7½".
Stainless steel 704.737.17



VÄLVÄRDAD Dish drying rack
L12½×W4¾×H6¼". Fits 10 plates.
Stainless steel 604.737.13



VÄLVÄRDAD Dish drain Galvanized steel.
White/galvanized
L20½×W13¾×H¾" 306.053.24



VÄLVÄRDAD Dish drain Galvanized steel.
Beige
L13¾×W6" 404.301.64

Sink accessories



NORRSJÖN Chopping board, L17¼×W16½".
You can place the chopping board over the sink to get more space on the countertop and to hide dirty dishes.

Solid oak 604.584.49



NORRSJÖN Colander L16½×W7½×H3½".
The colander is designed to rest steadily on the edges of the sink bowl. You can use it as a colander to rinse vegetables and salad or drain pasta.

Stainless steel 003.397.13

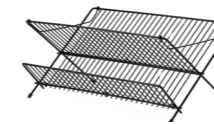

KVOT Dish drainer Plates and dishes on top, and glasses and bowls below. This robust drainer happily takes care of the washing up. And after everything has dried, it's simple to fold up and set aside until next time.

L18¾×W11¾×H9" 106.053.15



ORDNING This stainless steel dish drainer has space for 29 plates – and a whole bunch of bowls and glasses. Holds plates up to Ø13".

L19¾×W10¾×14¾" 100.181.94



ORDNING Utensil holder This stainless-steel stand is just as suitable for wet cutlery by the sink as for clean and dry cutlery on a shelf.

Ø4¾, H5¾" 300.118.32
Ø4¾, H7¾" 301.317.16



ÖBONÄS Triple hook with suction cup
W2¾×H4¼".

Gray-beige 806.060.95



ÖBONÄS Container with suction cup
W5¼×D4×H8¾".

Gray-beige 906.060.90



ÖBONÄS Wall shelf with suction cup
W22×D4×H4¾".

Gray-beige 406.061.01



Knobs and handles

Small details that make a difference!

Knobs and handles are like icing on the cake or your kitchen's jewelry. Enhance the style you like, refresh the look of doors and drawers, coordinate with the rest of your home — or simply change because it's fun.

Knobs and handles may seem small but they can help you to really personalize your kitchen. You can enhance a style to make your kitchen look more traditional or more modern. Mix them or match them perfectly and play with placements to create the finishing touches to the look you want in your dream kitchen.



FIXA Drill template

This simple tool helps you easily and accurately mark where you want to place your knobs and handles. 903.233.93



KNOBBS AND HANDLES

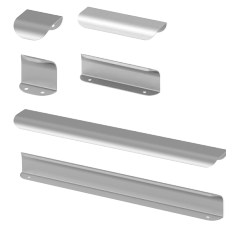

BILLSBRO Handles Stainless steel-color		
L1 9/16"	603.235.92	2pk
L11 15/16"	803.236.28	2pk
L15"	603.236.29	2pk
L18"	403.236.30	2pk
L21"	203.236.31	2pk
L27"	003.236.32	2pk
L33"	803.236.33	2pk



BILLSBRO Handles White		
L1 9/16"	203.343.14	2pk
L11 9/16"	903.343.15	2pk
L15"	903.343.01	2pk
L18"	603.343.07	2pk
L21"	003.343.10	2pk
L27"	903.343.20	2pk
L33"	703.343.21	2pk



BILLSBRO Handle White		
L87"	203.343.09	



BILLSBRO Handle Stainless steel-color		
L87"	103.235.99	

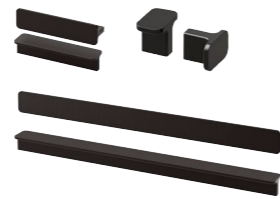

HACKÅS Handles Anthracite		
L3 15/16"	303.424.79	2pk
L11 13/16"	503.424.78	2pk
HACKÅS knob, anthracite.		
Ø9/16"	803.397.90	2pk



DRAGSMARK Clip-on handles White		
L1 9/16"	005.598.04	2pk



GUBBARP Handles White		
L4 9/16"	003.364.32	2pk

GUBBARP Knobs White		
Ø1 1/16"	803.364.33	2pk



STJÄRNHOV Handles Chrome plated		
L4 15/16"	606.096.22	2pk

STJÄRNHOV Knobs Chrome plated		
L1 5/16"	906.096.25	2pk



BAGGANÅS Handles Black		
L5 5/8"	803.384.13	2pk
L13 3/16"	603.384.14	2pk

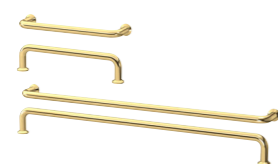

BAGGANÅS Handles Brass-color		
L5 5/8"	003.384.07	2pk
L13 3/16"	203.384.11	2pk



BAGGANÅS Handles Stainless steel		
L5 5/8"	703.384.18	2pk
L13 3/16"	503.384.19	2pk



BAGGANÅS Knobs Black		
Ø13/16"	903.384.17	2pk



BAGGANÅS Knobs Brass-color		
Ø13/16"	003.384.12	2pk



BAGGANÅS Knobs Stainless steel		
Ø13/16"	903.384.22	2pk



TÄRNSTAD Knobs Oak		
Ø11/16"	205.428.60	2pk



VINNÅSET Knobs Beech		
Ø1 7/16"	504.342.94	2pk



ÖSTERNÅS Handles Tanned leather		
L6"	403.488.95	2pk

KNOBBS AND HANDLES



KALERUM Handles Stainless steel-color		
L5 7/16"	605.536.44	2pk
L10 1/2"	305.536.50	2pk
L15 1/2"	405.536.59	2pk



KALERUM Knobs Stainless steel-color		
Ø1 3/16"	405.428.59	2pk



KALERUM Handles Brass-color		
L5 7/16"	405.965.50	2pk



KALERUM Knobs Brass-color		
Ø1 3/16"	605.965.54	2pk



KLINGSTORP Handles Black/chrome-plated		
L5 9/16"	405.652.85	2pk



KLINGSTORP Handles Off-white/chrome-plated		
L5 9/16"	905.536.85	2pk



SKRUVSHULT Handles Anthracite		
L6"	505.059.55	2pk

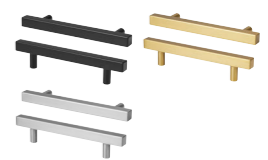

GRIBBOL Handles L5 1/2"		
Black	004.963.07	2pk
Brass-color	404.963.05	2pk
Chrome-plated	204.963.06	2pk



KLINGSTORP Knobs Black/chrome-plated		
Ø7/8"	305.652.81	2pk
L1 3/16"	905.652.83	2pk



KLINGSTORP Knobs Off-white/chrome-plated		
Ø7/8"	605.428.58	2pk
L1 3/16"	605.536.82	2pk



SKRUVSHULT Knobs Anthracite		
Ø11/16"	805.074.82	2pk
L1"	705.074.87	2pk



GRIBBOL Knobs L5 9/16"		
Black	704.963.23	2pk
Brass-color	504.963.24	2pk
Chrome-plated	204.963.25	2pk



ENERYDA Cup handles Black		
L3 1/2"	503.475.17	2pk



ENERYDA Knobs Black		
Ø1 1/16"	803.475.06	2pk



ENERYDA Knobs Chrome-plated		
Ø1 1/16"	003.475.10	2pk



KALLRÖR Handles Stainless steel		
L8 3/8"	503.570.02	2pk
L15 15/16"	103.570.04	2pk



ENERYDA Handles Black		
L4 7/16"	703.475.16	2pk



ENERYDA Cup handles Brass-color		
L3 1/2"	706.108.37	2pk



ENERYDA Cup handles Chrome-plated.		
L3 1/2"	403.475.13	2pk

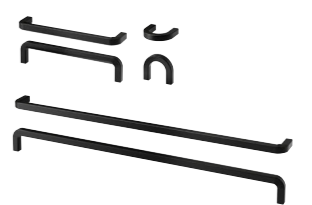

BORGHAMN Handles Steel		
L6 3/4"	203.160.46	2pk
L16 3/4"	403.189.78	2pk
BORGHAMN Knobs Steel		
L1 5/8"	003.160.47	2pk



ENERYDA Handles Brass-color		
L4 7/16"	306.108.58	2pk



ENERYDA Handles Chrome-plated		
L4 7/16"	603.475.12	2pk

LIMITED WARRANTY

GENERAL CONDITIONS

What is limited warranted?

The extent of the limited warranty given for each product is described alongside each product.

Duration of limited warranty

Each limited warranty lasts for the number of years stated against each product starting from the date of purchase.

What will IKEA do to correct the problem?

IKEA will examine the product and decide if it's covered under this limited warranty. IKEA will then, at its choice, either repair the defective product or replace it with the same or a comparable product. In these cases, IKEA will be responsible for the costs of repairs, spare parts, labor and travel for repair staff that IKEA incurs, provided that the product is accessible for repair without IKEA incurring additional expenditure to gain access. This will not apply in cases where repair work has not been authorized by IKEA. Any defected parts removed in the course of repair works will become the property of IKEA. If the item is no longer sold by IKEA, IKEA will provide an appropriate replacement. IKEA will decide at its discretion, what will constitute an appropriate replacement.

Conditions for the limited warranties

The limited warranties are valid from the date of purchase at IKEA. The original purchase receipt is required as proof of purchase.

Exclusions

The limited warranties do not apply to products that have been stored or assembled incorrectly, used inappropriately, abused, misused, altered or cleaned with wrong cleaning methods or wrong cleaning products. Follow our assembly instructions and care instructions carefully.

The limited warranties do not cover normal wear and tear, cuts or scratches or damage caused by impacts, accidents or waterborne debris.

The limited warranties do not apply if products have been placed outdoors, in a humid environment, in a corrosive environment or if the products have been used for non-residential purposes (unless otherwise stated).

The limited warranties do not cover consequential or incidental damages. Some states do not allow the limitation or exclusion of incidental or consequential damage, so this limitation or exclusion may not apply to you.

For details see the limited warranty conditions and description for every product.

Care instructions

To be able to rely on this limited warranty you need to follow the specific care instructions for every product.

► You will find all care instructions in the IKEA stores and on the IKEA website: IKEA.us

General legal rights

This limited warranty gives you specific legal rights. This limited warranty does not, in any way, affect the rights given to you by law.

How to reach us if you need service:

Contact your local IKEA store.

► You will find the address and phone number in the IKEA catalog or at IKEA.us. Save your sales receipt as proof of purchase.

► Proof of purchase is required for the limited warranties to be valid.

► For more information, see the IKEA Kitchen limited warranty booklet at IKEA.us/warranty.

25
Year Limited
Warranty
Included

SEKTION KITCHEN SYSTEM

What products are covered under this limited warranty?

This limited warranty applies to residential kitchen use only. It covers defects in material and workmanship in the SEKTION kitchen system. This limited warranty

covers all of the following parts of the SEKTION kitchen system: • Cabinet frames • Fronts • Wall rail • UTRUSTA hinges • MAXIMERA fully-extending drawers • UTRUSTA shelves of tempered glass and melamine • Toe-kicks • Legs • Door dampers • Push opener for doors • Cover panels • Deco strips/moldings • Pre-cut countertops • Sinks except FYNDIG.

Products not covered under this limited warranty:

• Knobs and handles and VÅGLIG connecting rails.

10

UTRUSTA wire baskets • UTRUSTA push opener electrical • VADHOLMA and TORNVIKEN open cabinets • TORNVIKEN kitchen island • ÅSPINGE kitchenette • ÖNNERUP kitchenette have a 10-year limited warranty.

10

ENHET KITCHEN SYSTEM

What is covered under this limited warranty?

The 10-year limited warranty is valid for all ENHET products. This limited warranty applies to residential use only.

Products not covered under this limited warranty:

• Knobs and handles

5

KNOXHULT KITCHEN SYSTEM

What is covered under this limited warranty?

The 5-year limited warranty is valid for all KNOXHULT products. This limited warranty applies to residential use only.

Products not covered under this limited warranty:

• Knobs and handles

10

KITCHEN FAUCETS

What is covered under this warranty?

The 10-year limited warranty is valid for all kitchen faucets at IKEA. This limited warranty applies to residential use only and covers defects in material and workmanship in all kitchen faucets. Our kitchen

faucets are tested well beyond all relevant international standards and we use only top brand components to secure our 10-year limited warranty promise.

Exclusions

The limited warranty does not apply to the filter/aerator which should be cleaned regularly or replaced when worn out. Follow our assembly instructions and care instructions carefully.

LIFETIME
Limited
Warranty
Included

LOCKEBO GLASS COMPOSITE COUNTERTOPS

Limited residential lifetime warranty

- Thickness of LOCKEBO is 3mm.
- Color may vary slightly from in-store samples.
- Glass composite is not perfectly smooth, minor pitting is common and does not affect the performance or constitute a material defect.

Conditions for the limited warranty

- Owner must register warranty on or before 30 days of installation at www.Caesarstoneus.com.
- Original proof of purchase receipt is required.

What is covered under this limited warranty?

- Warranty against any manufacturing performed by the supplier, as well as the correct installation of the product.
- The warranty is effective only if the owner of the countertop is the occupant of an indoor single-family residence.

What is not covered under this limited warranty?

- The warranty does not protect against natural causes (e.g., fire, flood, tornado, etc.).
- Does not cover wear and tear such as stains, scratches, water spots and burns.
- Does not cover failure to comply with care instructions.
- Does not cover chips or damage from abuse or excessive impact.
- Does not cover any products moved from their original place of installation.
- Does not cover repair to electrical, tile or wall surfaces and plumbing modifications possibly required to install the custom countertop.
- Does not cover damages from alterations performed after initial installation.

Care instructions

- Clean with soap and water on a regular basis. For tougher dirt, use warm water and a damp cloth or a Scotch Brite delicate sponge pad with a small amount of non-abrasive cleaner that does not contain bleach.
- Trivets and hot pads must be used when placing hot skillets, pans, crock-pots or other heat generating kitchenware on the surface.
- Using cutting boards and taking care not to drop or move heavy objects on the surface will help to ensure long-lasting beauty.

Planning needs

- For LOCKEBO custom countertop planning needs and term and conditions, please see a co-worker at your local IKEA store.

NEED HELP?

You can contact us in different ways:

Online: Read the FAQs at [IKEA.us](https://www.IKEA.us)—they might answer your question: [IKEA.us/FAQ](https://www.IKEA.us/FAQ)

In person: Speak to us in store—those friendly people in the yellow and blue shirts are ready to help you through your buying process.

By phone: If you ever need to talk to us in person, we're happy to answer your call. You can reach us over the phone at: 1-888-888-IKEA (4532)

Installation Services: Save time and effort with professional installation. For full details visit [IKEA.us/kitchenservices](https://www.IKEA.us/kitchenservices)

Special Information

This buying guide has been prepared by IKEA to better assist customers when purchasing products. Sources of supply and specifications are subject to change. Every reasonable effort will be made to ensure that all advertised merchandise is available in adequate supply. A high standard of accuracy has been sought in the preparation of this buying guide. Errors and omissions are always a possibility. Although IKEA cannot be held responsible, upon discovery of any error or omission, all reasonable steps will be taken to inform IKEA customers.

Country of origin

For all our products, we choose specialized manufacturers who can produce our components at the lowest price. A single item may consist of several components from different countries. Country of origin information is available on each component when you pick it up.

NEW

This symbol appears on products that are new in the buying guide this year. New items continue to arrive all the time, so visit the store often.

Stock Availability

Not all products may be available in all stores. See what is available in your local store by visiting [IKEA.us](https://www.IKEA.us)

Valid as of May 1, 2026 posting. Prices and availability of products are subject to change without notice. Please see [IKEA.us](https://www.IKEA.us) or your local IKEA store for the most up to date pricing.

