

Buying guide

PAX & KOMPLEMENT

Wardrobe system

Safety

Secure It! Prevent tip-over injury. Furniture with included restraints must be secured to the wall according to the assembly instructions.

Different wall materials require different types of hardware. Use hardware (sold separately) suitable for the walls in your home.

PAX frames must be mounted flush to the wall, according to assembly instructions.

Assembly

Minimum ceiling heights required:
D22 $\frac{7}{8}$ ×H79 $\frac{1}{4}$ " : 82 $\frac{1}{2}$ "
D22 $\frac{7}{8}$ ×H93 $\frac{3}{8}$ " : 95 $\frac{3}{4}$ "

IMPORTANT: Two people are required to assemble this furniture safely.

10

The PAX Wardrobe system has a 10-year limited warranty. Read more in the limited warranty booklet at IKEA-USA.com/warranty

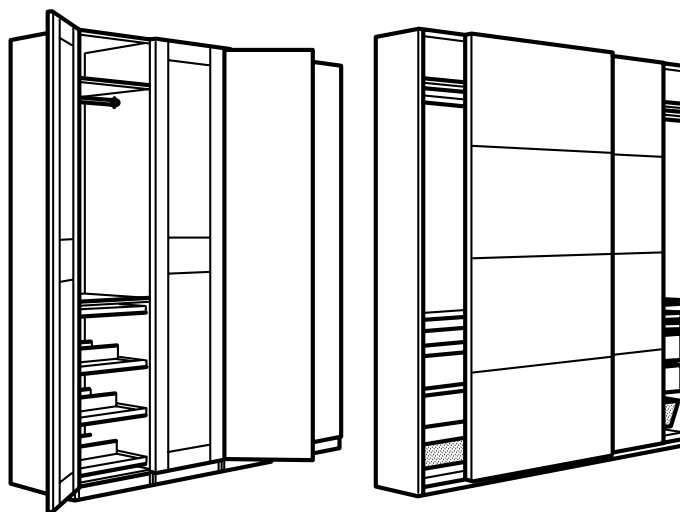

Create your own wardrobe

By combining frames and doors from the PAX series with items from the KOMPLEMENT series of interior organizers, you can create exactly the wardrobe you need. Or you can choose one of our suggested storage solutions and add or remove interior organizers as you wish. Whatever you choose, the result is a wardrobe to suit both your home and your clothes.

Use our planning tools

You can create your wardrobe in the planner found in the PAX area of the store or in the comfort of your own home. Just visit the bedroom section of the IKEA website, go to the PAX planner at IKEA-USA.com/PAXplanner and start making a wardrobe uniquely designed for you, by you.

Do it yourself or let us help

You might well be able to do everything yourself, but you don't have to! Let us help make your wardrobe dream a reality with our service offers like home delivery and assembly. Read more at the end of this buying guide or visit IKEA-USA.com/services

A high standard of accuracy has been sought in the preparation of this buying guide. We apologize for, but will not be bound by or responsible for, errors and omissions in this buying guide.

Not all products may be available in all stores. See what is available at your local store by visiting IKEA-USA.com. For more detailed product information, see the price tag or visit IKEA-USA.com. All products shown require assembly. All textiles shown are imported.



Choose your wardrobe

We have a wide range of PAX/KOMPLEMENT combinations to choose from which you can find in the store or on our website at IKEA-USA.com. If you don't find a pre-designed solution that you like, you can use our PAX/KOMPLEMENT planner to create the perfect solution that suits your needs and taste.

Begin by looking through the ready-made combinations on the web or in the planner gallery and choose one that inspires you. You will then have a pre-designed combination to start from that you can customize to your needs. You can, for example, change the size and the color of the wardrobe, or the interior organizers.

You can also use the planner to design your own unique PAX/KOMPLEMENT combination from scratch. There are three simple steps to follow when choosing your wardrobe solution.

- 1. Choose frames.** Consider how much space you have available in your room. It's important to know the maximum height and width of your new wardrobe. Remember, you can also make the most of unused space with corner units.
- 2. Pick your style.** What color do you want your wardrobe to be? We can offer a wide selection selection of doors in different colors.

- 3. Choose interior organizers.** Think through your day-to-day needs. Do you have a lot of shoes? Then a pull-out tray with shoe inserts could be a good option for you. Or perhaps you have a lot of pants? Then a pants hanger will come in handy. If you keep your summer and winter clothes in the same place, deep baskets will store your clothes neatly away.

Once you have decided on the interior organizers, it's time to add the finishing touches. Complete your new wardrobe with your choice of boxes and inserts from our extensive range of interior accessories. And for a really great result, don't forget the integrated lighting! Simple to install and makes it so much easier for you to find the right outfit.

The PAX/KOMPLEMENT planner helps you to calculate the price of your wardrobe and allows you to print or save a product list that you can bring to the store or use to buy online.

The planner can be found in the wardrobe area of the store or in the comfort of your own home. Just visit the wardrobe department on the IKEA website and go to the PAX/KOMPLEMENT wardrobe planner:
IKEA-USA.com/PAXplanner

Good to know measurements

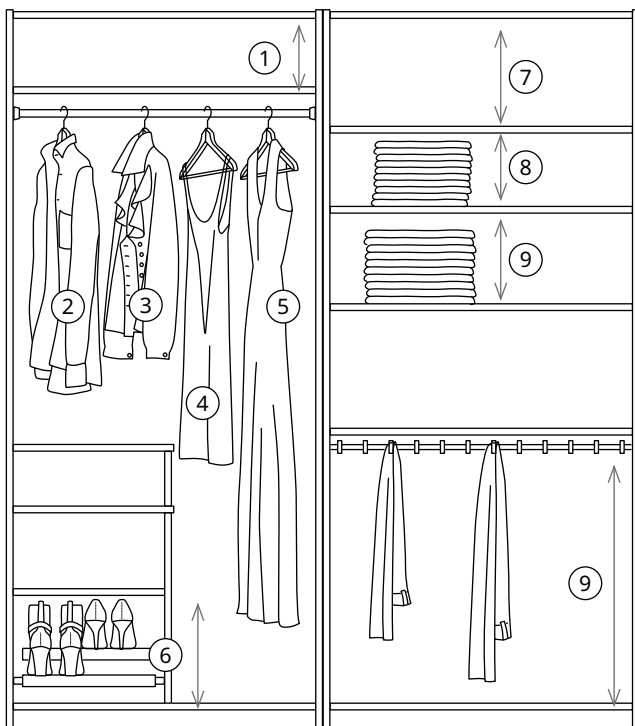

Hard to know how much space your clothes will take? Here's a useful guide of a few measurements and generic clothes sizes that could come in handy when planning your wardrobe.

1. Plan 7½" to fit HEMMAFIXARE storage boxes.
2. Plan approximately 39" for coats.
3. Plan approximately 32" for blouses.
4. Short dresses need approximately 47".
5. Really long garments might need up to 75".
6. Plan 13" for a pull-out shoe shelf.
7. Plan approximately 11" to fit a HEMMAFIXARE storage box.
8. Plan approximately 10" for 10 folded t-shirts.
9. Plan approximately 12" for 10 folded sweaters.
10. Plan approximately 9-10" for hanging pants.

Frames

Width×Depth×Height

10 The PAX Wardrobe system has a 10-year limited warranty. Read more in the limited warranty booklet at IKEA-USA.com/warranty

Choose frames in the height, width and depth that suits your home. You can choose between 79¼" and 93½" high frames, a depth of 13¾" or 22½" and a width of 19½", 29½" and 39¼". Available colors for each size are listed below.

Depth 22½", Height 79¼"



Wall-mounted storage frame with rail 19½×22½×79¼".

White	605.881.58
Gray-beige	205.881.84
Dark gray	505.881.68

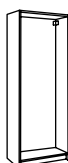

Wall-mounted storage frame with rail 29½×22½×79¼".

White	805.881.62
Gray-beige	705.881.86
Dark gray	105.881.70



Wall-mounted storage frame with rail 39¼×22½×79¼".

White	905.881.66
Gray-beige	605.881.82
Dark gray	705.881.72

Depth 22½", Height 93½"



Wall-mounted storage frame with rail 19½×22½×93½".

White	405.881.59
Gray-beige	905.881.85
Dark gray	305.881.69

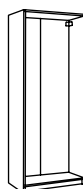

Wall-mounted storage frame with rail 29½×22½×93½".

White	605.890.06
Gray-beige	505.881.87
Dark gray	905.881.71



Wall-mounted storage frame with rail 39¼×22½×93½".

White	705.881.67
Gray-beige	405.881.83
Dark gray	505.881.73

Depth 13¾", Height 79¼"

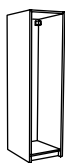

Wall-mounted storage frame with rail 19½×13¾×79¼".

White	005.881.56
Dark gray	605.881.77

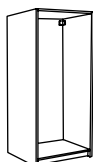

Wall-mounted storage frame with rail 29½×13¾×79¼".

White	205.881.60
Dark gray	205.881.79

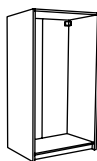

Wall-mounted storage frame with rail 39¼×13¾×79¼".

White	405.881.64
Dark gray	005.881.75

Depth 13¾", Height 93½"



Wall-mounted storage frame with rail 19½×13¾×93½".

White	805.881.57
Dark gray	405.881.78



Wall-mounted storage frame with rail 29½×13¾×93½".

White	005.881.61
Dark gray	805.881.81



Wall-mounted storage frame with rail 39¼×13¾×93½".

White	105.881.65
Dark gray	805.881.76

Create a corner solution

10 The PAX Wardrobe system has a 10-year limited warranty. Read more in the limited warranty booklet at IKEA-USA.com/warranty

With this add-on unit for corner frame, you can also make use of the corners when building your wardrobe. It fits all frames in the PAX wardrobe system, so all you need to do is combine the add-on unit with the frame that suits your space best. No matter which depth or height you choose for your add-on unit, four adjustable shelves are always included. You can also

complete with 13 $\frac{3}{4}$ " deep interior organizers from the KOMPLEMENT series to create exactly the wardrobe you've dreamed of.

Depth 22 $\frac{7}{8}$ ", Height 79 $\frac{1}{4}$ "

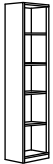

Add-on unit for corner, 20%×22 $\frac{7}{8}$ ×79 $\frac{1}{4}$ ".

White	703.469.32
Gray-beige	505.151.10
Dark gray	605.151.19

Depth 22 $\frac{7}{8}$ ", Height 93 $\frac{1}{8}$ "



Add-on unit for corner, 20%×22 $\frac{7}{8}$ ×93 $\frac{1}{8}$ ".

White	303.469.34
Gray-beige	105.151.12
Dark gray	205.151.21

Depth 13 $\frac{3}{4}$ ", Height 79 $\frac{1}{4}$ "

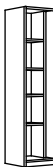

Add-on unit for corner, 20%×13 $\frac{3}{4}$ ×79 $\frac{1}{4}$ ".

White	403.469.38
Dark gray	705.151.14

Depth 13 $\frac{3}{4}$ ", Height 93 $\frac{1}{8}$ "

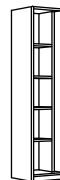

Add-on unit for corner, 20%×13 $\frac{3}{4}$ ×93 $\frac{1}{8}$ ".

White	803.469.41
Dark gray	205.151.16

How to build

Here you can see how the add-on unit for corner frame can be used with other frames. The examples shown here are combinations that work together with hinged doors. For open

storage solutions, there are even more possibilities – please see more at IKEA-USA.com or ask a co-worker at your nearest IKEA store.

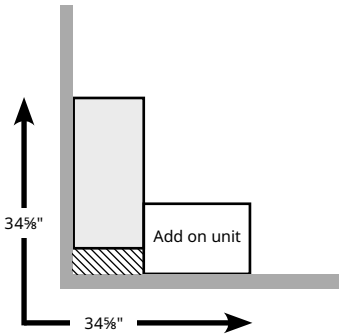

13 3/4" deep add-on unit for corner with one 29 1/2 x 13 3/4" frame.

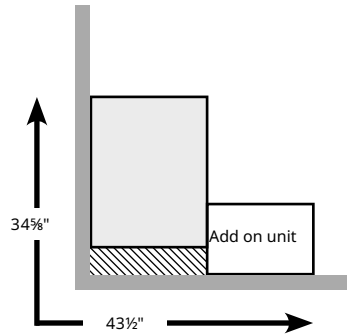

13 3/4" deep add-on unit for corner with one 29 1/2 x 22 7/8" frame.

Suggestion of interior organizers to use in this combination

Standard frame 29 1/2 x 13 3/4":

- Clothes rail 29 1/2 x 13 3/4"
- Shelf 29 1/2 x 13 3/4"
- Shoe shelf 29 1/2 x 13 3/4"
- Multi-use hanger 13 3/4"

Add-on unit for corner:

All 13 3/4" deep KOMPLEMENT interior organizers.

Suggestion of interior organizers to use in this combination

Standard frame 29 1/2 x 22 7/8":

- Clothes rail 29 1/2 x 22 7/8"
- Shelf 29 1/2 x 22 7/8"
- Multi-use hanger 22 7/8"

Add-on unit for corner:

All 13 3/4" deep KOMPLEMENT interior organizers.

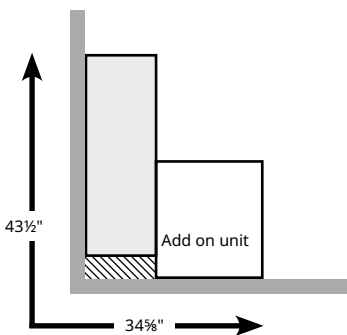

22 7/8" deep add-on unit for corner with one 39 1/4 x 13 3/4" frame.

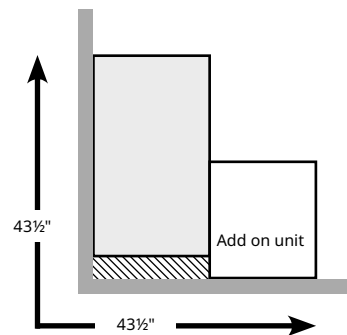

22 7/8" deep add-on unit for corner with one 39 1/4 x 22 7/8" frame.

Suggestion of interior organizers to use in this combination

Standard frame 39 1/4 x 13 3/4":

- Clothes rail 39 1/4 x 13 3/4"
- Shelf 39 1/4 x 13 3/4"
- Shoe shelf 39 1/4 x 13 3/4"
- Divider for frame 19 5/8" with your choice of pull-out interior organizers
- Multi-use hanger 13 3/4"

Add-on unit for corner:

All 13 3/4" deep KOMPLEMENT interior organizers.
Clothes rail 19 5/8 x 22 7/8" (turn the fitting around).

Suggestion of interior organizers to use in this combination

Standard frame 39 1/4 x 22 7/8":

- Clothes rail 39 1/4 x 22 7/8"
- Shelf 39 1/4 x 22 7/8"
- Divider for frame 19 5/8" with your choice of pull-out interior organizers
- Multi-use hanger 22 7/8"

Add-on unit for corner:

All 13 3/4" deep KOMPLEMENT interior organizers.
Clothes rail 19 5/8 x 22 7/8" (turn the fitting around).

Hinged doors

Handles and knobs are sold separately except where noted. See our complete range of knobs and handles in the store or at IKEA-USA.com/knobshandles

All available hinged doors are listed below. Remember to pick up one 3-pack of KOMPLEMENT hinges for each 76¾" tall door, and one 4-pack of KOMPLEMENT hinges for each 90¾" tall door. If you choose to add doors to a corner frame, remember to

purchase a 6-pack of corner-specific hinges for 76¾" doors, and an 8-pack for 90¾" doors. The soft closing hinges catches the door and close it slowly, silently and softly.

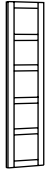

BERGSBO Door White	
19½×76¾"	202.074.10
19½×90¾"	301.604.07
Gray-beige	
19½×76¾"	905.109.45
19½×90¾"	505.109.47
Dark gray	
19½×76¾"	605.109.37
19½×90¾"	205.109.39



BERGSBO Door White/frosted glass	
19½×90¾"	501.604.06

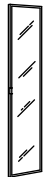

ÅHEIM Door Mirror glass	
9¾×76¾"	204.148.29
9¾×90¾"	004.148.30
19½×76¾"	803.319.30
19½×90¾"	804.100.55



GRIMO Door White	
19½×76¾"	403.434.64
19½×90¾"	903.434.66
Gray	
19½×76¾"	204.351.86
19½×90¾"	804.351.88



FARDAL Door High-gloss white	
9¾×76¾"	703.446.26
9¾×90¾"	503.446.27
19½×76¾"	901.905.24
19½×90¾"	801.905.29
High-gloss dark beige	
19½×76¾"	403.306.21
19½×90¾"	303.306.07

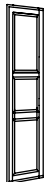

TYSSEDAL Door White	
19½×76¾"	902.981.24
19½×90¾"	402.981.26



TYSSEDAL Door White/glass	
19½×90¾"	803.291.97



TYSSEDAL Mirror door	
19½×90¾"	004.491.13



FORSAND Door White	
9¾×76¾"	204.236.02
9¾×90¾"	804.236.04
19½×76¾"	403.910.92
19½×90¾"	603.910.91

Gray stained ash effect	
19½×76¾"	405.109.24
19½×90¾"	505.109.28

Gray-beige	
19½×76¾"	905.109.26
19½×90¾"	905.109.31

Dark gray	
19½×76¾"	405.109.24
19½×90¾"	505.109.28



MISTUDDEN Door Gray/patterned	
19½×76¾"	005.685.49
19½×90¾"	805.685.50



REINSVOLL Door Gray-beige	
19½×76¾"	004.731.41
19½×90¾"	604.731.38



TONSTAD Door Brown stained oak veneer	
19½×76¾"	005.102.52
19½×90¾"	305.102.55

Brown stained oak veneer glass	
19½×76¾"	705.525.02
19½×90¾"	105.525.00

Oak veneer	
19½×76¾"	505.102.59
19½×90¾"	905.102.62

Oak veneer glass	
19½×76¾"	905.525.01
19½×90¾"	505.525.03

Hinged doors



GULLABERG Door	
White	
19½×76¾"	405.806.67
19½×90¾"	805.806.65
Gray	
19½×76¾"	105.806.64
19½×90¾"	605.806.66



STORKLINTA Door	
Oak effect	
19½×76¾"	105.843.65
19½×90¾"	105.843.70
Dark brown oak effect	
19½×76¾"	405.843.64
19½×90¾"	905.843.71

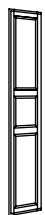

FLISBERGET Door	
Light beige	
19½×90¾"	603.447.35



KOMPLEMENT Soft closing hinges	
For doors with a height of 76¾".	
3-pack	002.145.05
For doors with a height of 90¾".	
4-pack	302.145.04



KOMPLEMENT Soft closing hinges for add on corner unit	
For doors with a height of 76¾".	
6-pack	103.684.89
For doors with a height of 90¾".	
8-pack	503.684.92

Handles

The handles below are developed specially to fit doors for PAX wardrobes.

You can find even more knobs and handles to choose from at IKEA-USA.com/knobshandles

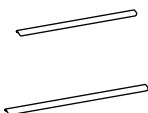

BILLSBRO Handle White. 1pk.	
33"	703.343.21
87¾"	203.343.09

BILLSBRO Handle Stainless steel. 1pk	
33"	803.236.33
87¾"	103.235.99

Sliding doors

10

The PAX Wardrobe system has a 10-year limited warranty. Read more in the limited warranty booklet.

The sliding doors are sold in pairs. The size and price refers to the total measurement of the two doors together.

The soft opening and closing device is integrated into the rail for all sliding doors. It catches the running doors and makes sure they open and close slowly, silently and softly.

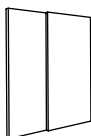

HASVIK Pair of sliding doors The soft open/closing mechanism is integrated into the rail.

White

59×79½"	105.215.37
78¾×79½"	705.215.39
59×92½"	905.215.38
78¾×92½"	305.215.41

Gray-beige

59×79½"	205.109.58
78¾×79½"	805.109.60
59×92½"	405.109.62
78¾×92½"	005.109.64

Dark gray

59×79½"	905.109.50
78¾×79½"	105.109.54
59×92½"	505.109.52
78¾×92½"	605.109.56

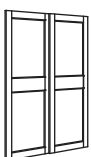

GRIMO Pair of sliding doors, white. The soft open/closing mechanism is integrated into the rail.

White

59×79½"	205.215.27
78¾×79½"	205.215.32
59×92½"	805.215.29
78¾×92½"	805.215.34

Glass/white

59×79½"	105.452.94
78¾×79½"	405.452.97
59×92½"	605.453.00
78¾×92½"	005.453.03

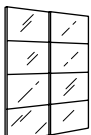

SVARTISDAL Pair of sliding doors* The soft open/closing mechanism is integrated into the rail.

White paper effect with aluminum metal frame

59×79½"	294.397.88
78¾×79½"	294.397.93
59×92½"	894.397.90
78¾×92½"	794.397.95

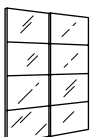

BJÖRNÖYA Pair of sliding doors* The soft open/closing mechanism is integrated into the rail.

Gray tinted effect with aluminum metal frame

59×79½"	894.396.86
78¾×79½"	894.396.91
59×92½"	494.396.88
78¾×92½"	494.396.93

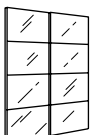

AULI Mirror, pair of sliding doors* The soft open/closing mechanism is integrated into the rail.

Mirror with aluminum metal frame

59×79½"	395.602.79
78¾×79½"	595.602.83
59×92½"	995.602.81
78¾×92½"	095.602.85



HOKKSUND Pair of sliding doors* The soft open/closing mechanism is integrated into the rail.

High gloss light gray with aluminum metal frame

59×79½"	094.397.08
78¾×79½"	094.397.13
59×92½"	694.397.10
78¾×92½"	594.397.15



MEHAMN Double sided, pair of sliding doors* The soft open/closing mechanism is integrated into the rail.

White/white stained oak with aluminum metal frame

59×79½"	794.397.62
78¾×79½"	594.397.77
59×92½"	094.397.70
78¾×92½"	894.397.85

Dark gray/gray-beige with aluminum metal frame

59×79½"	194.362.62
78¾×79½"	094.362.67
59×92½"	794.362.64
78¾×92½"	694.362.69

Light blue/light green with aluminum metal frame

59×79½"	195.485.42
78¾×79½"	795.485.44
59×79½"	995.485.43
78¾×79½"	495.485.45

*NOTE: The door is divided into three packages. Please use a picking list to ensure you collect one door frame and two packages of door panels.

Create your own sliding door

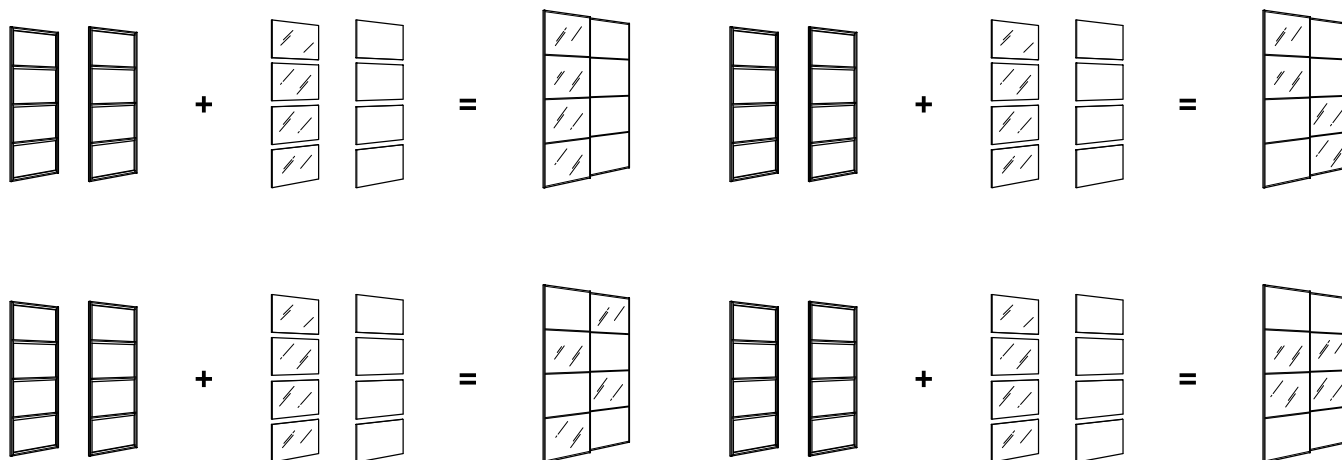

You can also choose your own combination of metal frames and panels for your sliding doors. The metal frame is available in white, black and aluminum and the panels come in a variety of materials and colors. Choose one frame and two packages of panels for each sliding door.

You will find all sliding door frames and panels on our website [IKEA-USA.com/PAXplanner](https://www.ikea.com/us/en/paxplanner)

You can also create your own sliding door in the PAX planning tool or contact staff at the PAX area in the store for more info.

Interior organizers

10 The PAX Wardrobe system has a 10-year limited warranty. Read more in the limited warranty booklet.

Organize all your shoes, ties, bed linen, lingerie, scarves, pants, handbags, shoes, jewelry etc. The KOMPLEMENT range perfectly matches the different doors and frames in the PAX series.

Width and depth of KOMPLEMENT articles is stated to match the dimensions of the corresponding frame, actual dimensions vary.

Fits 13³/₄" deep frames



KOMPLEMENT Clothes rail		
19¹/₂×13³/₄"		
White		504.464.52
Dark gray		905.094.66
29¹/₂×13³/₄"		
White		804.464.55
Dark gray		305.094.69
39¹/₂×13³/₄"		
White		104.464.49
Dark gray		605.094.63

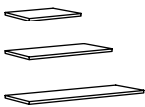

KOMPLEMENT Shelf		
For 19¹/₂×13³/₄"		
White		402.779.92
Dark gray		205.094.55
For 29¹/₂×13³/₄"		
White		702.779.95
White stained oak effect		502.735.02
Dark gray		605.094.58
For 39¹/₂×13³/₄"		
White		002.779.89
White stained oak effect		102.735.04
Dark gray		905.094.52

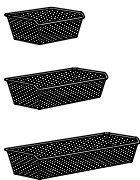

KOMPLEMENT Mesh basket To be completed with KOMPLEMENT pull-out rail for basket 13 ³ / ₄ ". Sold separately.		
19¹/₂×13³/₄"		
Dark gray		402.573.00
White		002.573.02
29¹/₂×13³/₄"		
Dark gray		702.573.08
White		102.573.11
39¹/₂×13³/₄"		
Dark gray		302.572.92
White		902.572.94

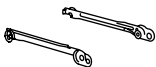

KOMPLEMENT Pull-out rails for baskets 13 ³ / ₄ "		
Dark gray		902.632.33 2pk
White		602.632.44 2pk



KOMPLEMENT Drawer		
19¹/₂×13³/₄"		
White		302.467.22
Dark gray		105.095.02
29¹/₂×13³/₄"		
White		702.467.44
Dark gray		405.095.05
39¹/₂×13³/₄"		
White		702.467.58
Dark gray		005.094.99

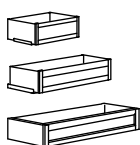

KOMPLEMENT Drawer with framed front		
19¹/₂×13³/₄"		
White		804.465.92
Dark gray		205.095.25
29¹/₂×13³/₄"		
White		104.465.95
Dark gray		805.095.27
39¹/₂×13³/₄"		
White		404.465.89
Dark gray		705.095.23

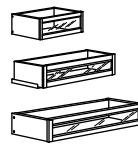

KOMPLEMENT Drawer with framed glass front		
19¹/₂×13³/₄"		
White		204.470.14
29¹/₂×13³/₄"		
White		504.470.17
39¹/₂×13³/₄"		
White		804.470.11



KOMPLEMENT Pull-out tray		
19¹/₂×13³/₄"		
White		50433987
Dark gray		105.094.89
29¹/₂×13³/₄"		
White		904.339.90
Dark gray		505.094.92
39¹/₂×13³/₄"		
White		204.339.84
Dark gray		705.094.86



KOMPLEMENT Pull-out pants hanger		
19¹/₂×13³/₄"		
White		804.465.49
Dark gray		605.094.77
29¹/₂×13³/₄"		
White		204.465.52
Dark gray		805.094.81
39¹/₂×13³/₄"		
White		604.465.45
Dark gray		505.094.73

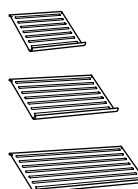

KOMPLEMENT Shoe shelf		
19¹/₂×13³/₄"		
Dark gray		002.572.55
White		602.572.57
29¹/₂×13³/₄"		
Dark gray		202.572.59
White		802.572.61
39¹/₂×13³/₄"		
Dark gray		902.572.51
White		502.572.53



KOMPLEMENT Valet hanger		
6³/₄×3¹/₂×2"		
Dark gray		602.571.82
White		702.569.31



KOMPLEMENT Drawer mat 35×20". Easy to cut to the desired size.		
Light gray		304.339.93

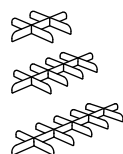

KOMPLEMENT Divider for pull-out tray Felt.		
19¹/₂×13³/₄"		
Light gray		504.675.62
29¹/₂×13³/₄"		
Light gray		804.675.65
39¹/₂×13³/₄"		
Light gray		704.66793

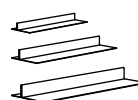

KOMPLEMENT Shoe insert for pull-out tray Felt.		
19¹/₂×13³/₄"		
Light gray		504.465.60
29¹/₂×13³/₄"		
Light gray		904.465.63
39¹/₂×13³/₄"		
Light gray		104.465.57

Interior organizers

Fits 22 $\frac{7}{8}$ " deep frames

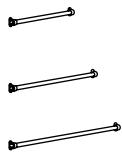

KOMPLEMENT Clothes rail 19$\frac{1}{2}$"	
Dark gray	402.569.42
White	902.568.93
29$\frac{1}{2}$"	
Dark gray	002.569.44
White	402.568.95
39$\frac{1}{2}$"	
Dark gray	802.569.40
White	302.568.91

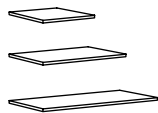

KOMPLEMENT Shelf For 19$\frac{1}{2}$×22$\frac{7}{8}$"	
White	302.779.59
Gray-beige	605.090.43
Dark gray	905.091.45
For 29$\frac{1}{2}$×22$\frac{7}{8}$"	
White	902.779.61
Gray-beige	705.090.47
Dark gray	105.091.49
For 39$\frac{1}{2}$×22$\frac{7}{8}$"	
White	702.779.57
Gray-beige	405.090.39
Dark gray	605.091.42

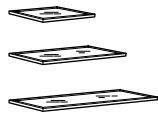

KOMPLEMENT Glass shelf For 19$\frac{1}{2}$×22$\frac{7}{8}$"	
White	002.576.46
Gray-beige	005.091.16
Dark gray	605.091.56
For 29$\frac{1}{2}$×22$\frac{7}{8}$"	
White	802.576.47
Gray-beige	405.091.19
Dark gray	005.091.59
For 39$\frac{1}{2}$×22$\frac{7}{8}$"	
White	702.576.38
Gray-beige	705.091.13
Dark gray	305.091.53

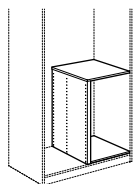

KOMPLEMENT Divider for frames 29 $\frac{1}{2}$ -39 $\frac{1}{2}$ ×22 $\frac{7}{8}$ ". Fits 29 $\frac{1}{2}$ " and 39 $\frac{1}{2}$ " wide PAX frames, 22 $\frac{7}{8}$ " deep.	
White	602.463.96
Gray-beige	105.091.06
Dark gray	005.092.15

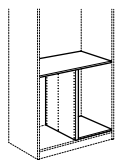

KOMPLEMENT Divider for frames 37 $\frac{1}{2}$ ×22 $\frac{7}{8}$ ×32 $\frac{1}{8}$ ".	
Gray-beige	305.091.10
Dark gray	405.092.18

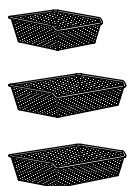

KOMPLEMENT Mesh basket To be completed with KOMPLEMENT pull-out rail for basket 22 $\frac{7}{8}$ ". Sold separately. 19$\frac{1}{2}$×22$\frac{7}{8}$"	
Dark gray	602.573.04
White	102.573.06
29$\frac{1}{2}$×22$\frac{7}{8}$"	
Dark gray	702.573.13
White	202.573.15
39$\frac{1}{2}$×22$\frac{7}{8}$"	
Dark gray	402.572.96
White	002.572.98

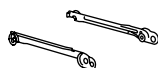

KOMPLEMENT Pull-out rails for 22$\frac{7}{8}$" basket		
Dark gray	102632.32	2pk
White	302.632.45	2pk

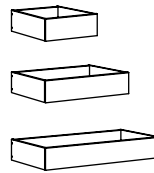

KOMPLEMENT Drawer 19$\frac{1}{2}$×22$\frac{7}{8}$"	
White	102.463.08
Gray-beige	605.090.76
Dark gray	205.091.96
29$\frac{1}{2}$×22$\frac{7}{8}$"	
White	102.463.32
Gray-beige	005.090.79
Dark gray	605.091.99
39$\frac{1}{2}$×22$\frac{7}{8}$"	
White	902.463.52
Gray-beige	505.090.72
Dark gray	905.091.93

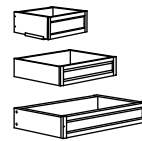

KOMPLEMENT Drawer with framed front 19$\frac{1}{2}$×22$\frac{7}{8}$"	
White	704.466.01
Dark gray	105.095.16
29$\frac{1}{2}$×22$\frac{7}{8}$"	
White	104.466.04
Dark gray	505.095.19
39$\frac{1}{2}$×22$\frac{7}{8}$"	
White	504.465.98
Dark gray	805.095.13

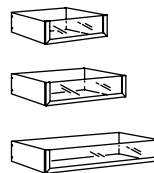

KOMPLEMENT Drawer with glass front 19$\frac{1}{2}$×22$\frac{7}{8}$"	
White	702.466.83
Gray-beige	505.090.86
Dark gray	105.092.05
29$\frac{1}{2}$×22$\frac{7}{8}$"	
White	102.466.95
Gray-beige	905.090.89
Dark gray	505.092.08
39$\frac{1}{2}$×22$\frac{7}{8}$"	
White	202.467.08
Gray-beige	205.090.83
Dark gray	805.092.02

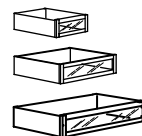

KOMPLEMENT Drawer with framed glass front 19$\frac{1}{2}$×22$\frac{7}{8}$"	
White	304.470.23
Dark gray	905.096.59
29$\frac{1}{2}$×22$\frac{7}{8}$"	
White	604.470.26
Dark gray	905.096.64
39$\frac{1}{2}$×22$\frac{7}{8}$"	
White	904.470.20
Dark gray	505.096.56



KOMPLEMENT Pull-out tray Combines with different inserts and shoe racks, see organizing accessories. 19$\frac{1}{2}$×22$\frac{7}{8}$"	
White	202.463.60
Gray-beige	805.090.99
Dark gray	105.091.87
29$\frac{1}{2}$×22$\frac{7}{8}$"	
White	302.463.74
Gray-beige	005.091.02
Dark gray	505.091.90
39$\frac{1}{2}$×22$\frac{7}{8}$"	
White	702.463.86
Gray-beige	405.090.96
Dark gray	805.091.84

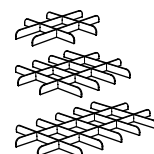

KOMPLEMENT Divider for pull-out tray Felt.	
19 $\frac{1}{2}$ ×22 $\frac{7}{8}$ "	204.667.95
29 $\frac{1}{2}$ ×22 $\frac{7}{8}$ "	804.667.97
39 $\frac{1}{2}$ ×22 $\frac{7}{8}$ "	704.667.93

Interior organizers

10

Most KOMPLEMENT accessories have a 10-year limited warranty. Read more in the limited warranty booklet.

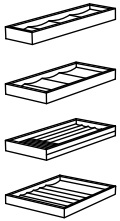

KOMPLEMENT Insert for pull-out tray Light gray.

To fit KOMPLEMENT pull-out tray 19½×22¾" you will need: One KOMPLEMENT insert 25×22¾" and one KOMPLEMENT insert 15×22¾" or one KOMPLEMENT insert 40×22¾".

To fit KOMPLEMENT pull-out tray 29½×22¾" you will need: Two KOMPLEMENT inserts 25×22¾" and one KOMPLEMENT insert 15×22¾" or one KOMPLEMENT insert 25×22¾" and one KOMPLEMENT insert 40×22¾".

To fit KOMPLEMENT pull out tray 39¾×22¾" you will need: Two KOMPLEMENT inserts 25×22¾" and one KOMPLEMENT insert 40×22¾" or three KOMPLEMENT inserts 25×22¾" and one KOMPLEMENT insert 15×22¾".

5¾×20¾" with four compartments	704.040.26
9¾×20¾" with four compartments	504.040.32
9¾×20¾" for jewelry	304.040.28
15¾×20¾" with compartments	504.040.27



KOMPLEMENT Pull-out pants hanger 19½×22¾"

White	304.465.37
Gray-beige	905.090.65
Dark gray	205.091.77

29½×22¾"

White	704.465.40
Gray-beige	305.090.68
Dark gray	405.091.81

39¾×22¾"

White	004.465.34
Gray-beige	605.090.62
Dark gray	105.091.73



KOMPLEMENT Pull-out shoe shelf 19½×22¾"

Dark gray	702.574.69
White	802.574.64



29½×22¾"

Dark gray	302.574.71
White	302.574.66

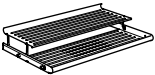

39¾×22¾"

Dark gray	102.574.67
White	002.574.63



KOMPLEMENT Valet hanger 6¾×2".

Dark gray	602.571.82
White	702.569.31



KOMPLEMENT Drawer mat 35×20". Easy to cut to the desired size.

Light gray	304.055.65
------------	------------

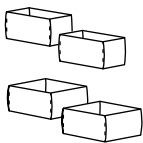

KOMPLEMENT Boxes Light gray.

6×10½×4¾"	005.617.36	set of 2
9¾×10½×4¾"	805.617.37	set of 2

Hangers



BUMERANG Coat-hanger

Natural	904.442.67
---------	------------



BUMERANG Hangers

Natural	302.385.43	8pk
White	702.385.41	8pk



BUMERANG Skirt hanger

Natural	404.324.79
---------	------------

Interior accessories

Fits 13¾" deep frames



HEMMAFIXARE Shoe boxes 9×13×7".
Fabric stripe/white/gray 105.260.97 **2pk**



HEMMAFIXARE Storage case 13½×20×7½".
Fabric stripe/white/gray 905.039.21

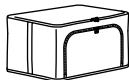

HEMMAFIXARE Storage case 3½×20×11".
Fabric stripe/white/gray 905.039.16



SKUBB Shoe boxes 8¾×13×6¼".
White 403.002.85 **4pk**
Dark gray 404.729.79 **4pk**



SKUBB Boxes Two of each: 5½×5½×5½", 11×5½×5½" and 11×11×5½".
White 205.385.42 **set of 6**
Dark gray 405.385.41 **set of 6**



TJENA Storage box with lid
9¾×13¾×7¾"
White 603.954.28



25×35×10 cm
White 903.954.22



9¾×13¾×7¾"
White 404.693.02

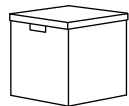

12½×13¾×12½"
White 903.743.49

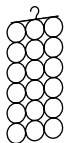

KOMPLEMENT Multi-use hanger White.
12½×28¼" 603.872.11



JÄGMÄSTARE Basket Felt. Gray
9¾×13¾×7¾" 205.558.76

Fits 22⅞" deep frames



HEMMAFIXARE Shoe boxes 9×13×7".
Fabric stripe/white/gray 105.260.97 **2pk**



HEMMAFIXARE Storage case 13½×20×7½".
Fabric stripe/white/gray 905.039.21

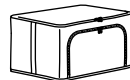

HEMMAFIXARE Storage case 3½×20×11".
White/gray 905.039.16



HEMMAFIXARE Storage case 417¼×20×7½".
White gray 205.039.10



HEMMAFIXARE Storage case 27¼×20×7½".
White gray 705.039.17



SKUBB Shoe boxes 8¾×13×6¼".
White 403.002.85 **4pk**
Dark gray 404.729.79 **4pk**



SKUBB Box Two of each: 5½×5½×5½", 11×5½×5½" and 11×11×5½".
White 205.385.42 **set of 6**
Dark gray 405.385.41 **set of 6**

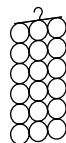

KOMPLEMENT Multi-use hanger White
12½×28¼" 603.872.11

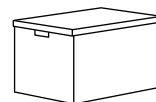

TJENA Storage box with lid 13¾×19¾×11¾".
White 903.743.49



KUGGIS Box 14½×21¼×8¼".
White 105.685.20



SKUBB Storage case 17×20¾×7½".
White 905.910.55
Dark gray 205.910.54



SKUBB Storage case 27¼×21¾×7½".
White 203.000.50
Dark gray 904.729.86



SKUBB Storage case 36½×21¾×7½".
White 005.385.43
Dark gray 904.729.91

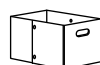

JÄGMÄSTARE Basket Felt. Gray
9¾×13¾×7¾" 405.559.60

Integrated lighting



ÖVERSIDAN LED wardrobe lighting strip with sensor is available in three colors that match PAX wardrobe frames perfectly. Illuminates the interior of PAX wardrobe so you can easily see and choose clothes, even on dark mornings. Easy to install inside the wardrobe frame – at the top or under a shelf by using the included fittings and the light switches on and off automatically when you open or close the door so no energy is wasted. As these lighting strips react to light, they work best with solid PAX doors. Works with IKEA Home smart. To be completed with TRÅDFRI LED driver and ANSLUTA power cord, sold separately. Dimmable.

18"	
Beige, 2.3W	005.246.83
White, 2.3W	204.750.40
Dark gray, 2.3W	704.750.33
28"	
Beige, 3.5W	405.246.95
White, 3.5W	204.750.64
Dark gray, 3.5W	804.750.56
38"	
Beige, 4.6W	205.246.96
White, 4.6W	604.750.19
Dark gray, 4.6W	304.750.11

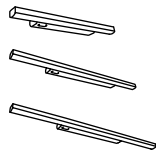

STÖTTA LED lighting strip Easy to place anywhere as it is battery operated and does not need to be connected to the mains supply. The light switches on and off automatically when you open or close the door so no energy is wasted. As these lighting strips react to light, they work best with solid PAX doors. Batteries are sold separately; 2-AA required for the 13"; 4-AA for the 20" and 28". IKEA recommends LADDA rechargeable batteries. Only for wardrobes with hinged doors. White

13"	103.600.87
20"	503.600.90
28"	903.600.93



TVÄRDRA Cabinet lighting The metal shade creates a direct light that illuminates your cabinet or wardrobe. If you want the lamp's light to be directed into your display cabinet, just angle the lamp head inwards. Provides a focused light that is good for lighting smaller areas. You can dim your lighting wirelessly and easily adapt the lighting based on activity. The bracket makes it possible to slide the lamp back and forth. You easily attach it with screws – or with double-sided adhesive on glass and metal surfaces. The LED light source consumes up to 85% less energy and lasts up to 20 times longer than incandescent bulbs. You can turn up to six light sources on and off simultaneously if you complete with ANSLUTA driver. If you also want to be able to dim, choose TRÅDFRI driver and STYRBAR remote control or RODRET wireless dimmer instead, sold separately.

Black, 1.5W	405.168.41
-------------	------------

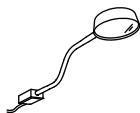

YTBERG Cabinet lighting The lamp's slim and neat design goes with most styles and is perfect if space is limited between the top of your wardrobe or cabinet and the ceiling. You can easily direct the light where you like since the flexible gooseneck arm can be bent and angled – perfect when it's time for homework, arts and crafts or cuddling up with a good book. Spreads a soft light that creates a cozy atmosphere in the room. The bracket makes it possible to slide the lamp back and forth. You easily attach it with screws – or with double-sided adhesive on glass and metal surfaces. You can dim your lighting wirelessly and easily adapt the lighting based on activity. The LED light source consumes up to 85% less energy and lasts up to 20 times longer than incandescent bulbs. You can easily direct the light where you like since the arm can be bent 180° and the lamp head angled 90°. You can turn up to six light sources on and off simultaneously if you complete with ANSLUTA driver. If you also want to be able to dim, choose TRÅDFRI driver and STYRBAR remote control or RODRET wireless dimmer instead, sold separately.

Black	105.278.98
White	505.168.31



ANSLUTA LED driver with cord Turn all connected light sources on and off with a single switch. (No dimming is possible with this driver.) Connect up to six units to the LED driver, as long as the total wattage does not exceed 19W. If you also want to be able to dim, choose TRÅDFRI driver and remote control instead, sold separately. White

White	904.058.45
-------	------------

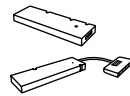

TRÅDFRI LED driver To be completed with ANSLUTA power supply cord, sold separately. These drivers will pair with TRÅDFRI dimmer and STYRBAR remote control for wireless operation. You can connect up to 10 TRÅDFRI LED drivers in one installation.

Up to 10W, connect up to 3 units.	103.561.89
Up to 30W, connect up to 9 units.	603.426.61



ANSLUTA Power supply cord For connecting your TRÅDFRI LED driver or multiple drivers to house power outlet. Press the cord switch for manual operations such as turning them all on and off simultaneously. Or for "smart" operations, pair your TRÅDFRI LED driver with TRÅDFRI dimmer or STYRBAR remote control. Add the DIRIGERA hub and manage operations using the IKEA Home smart app. White

L11'6"	301.214.11
--------	------------



ANSLUTA Intermediate connection cord Allows you to connect several LED drivers together with only one connection to the main power outlet. White

L28"	401.199.26
L79"	601.199.25



RODRET Wireless dimmer With RODRET wireless dimmer, you can dim, turn on/off your lighting without a wired-in installation. You can add up to 10 LED light sources so that they all switch on, off or are dimmed at the same time.

This product is part of our smart home range. Connect it, along with other smart products, to DIRIGERA hub and IKEA Home smart app for more features and functions. Can only be used with IKEA Smart lighting products. 1-AAA battery required, sold separately. IKEA recommends LADDA rechargeable battery HR03 AAA 1.2V.

White	805.598.00
-------	------------



STYRBAR Remote control Now it's easy for anyone to use smart lighting. STYRBAR remote control allows you to control multiple light sources with a click. Create atmosphere by dimming and adjusting color and warmth of the lights. Can only be used with IKEA smart lighting products. Works with IKEA Home smart app. 2-AAA batteries are required. Best powered with LADDA rechargeable batteries, sold separately.

Stainless steel	504.636.15
White	804.883.70



DIRIGERA Hub for smart products DIRIGERA hub is the heart of a smart home as it enables you to connect and control your smart products in the IKEA Home smart app. You can control your smart home using one or multiple mobile and tablet devices - just download the app to each one. DIRIGERA hub requires a Wi-Fi network and connects to your router with the provided cable. Together with the IKEA Home smart app, the DIRIGERA hub brings the most benefits to your smart home.

White	505.034.14
-------	------------



LADDA Rechargeable batteries Reduce waste and save money by recharging your batteries. Charging and reusing batteries is a good choice for the environment and practical too since you always have batteries at hand when you need them.

AA 1900mAh HR06 1.2V	005.098.14	4pk
AA 2450mAh HR06 1.2V	505.046.92	4pk
AAA 750mAh HR03 1.2V	905.098.19	4pk

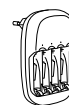

STENKOL Battery charger Four individual charging channels allow you to charge one or up to four batteries at a time. Suitable both for AA and AAA rechargeable NiMH batteries. Turns off automatically when the batteries are fully charged, defective or too warm. Gray-green

Gray-green	505.065.25
------------	------------

How to choose integrated lighting

Now you don't need to worry about getting bright light in your eyes or it waking up your partner when you look for clothes. Instead, you start the day when you open your wardrobe and the soft light from our LED lighting strips turns on. Or choose cabinet lighting placed on top of the wardrobe to help you see

what's on the top shelf that also provides a nice and cozy atmosphere in the entire room when the wardrobe doors are closed. You can even connect to IKEA Smart lighting using the DIRIGERA hub.

Basic parts

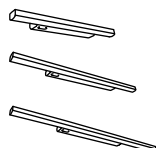

STÖTTA LED lighting strips. LADDA batteries

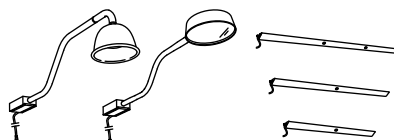

TVÄRDAG or YTBERG or ÖVERSIDAN

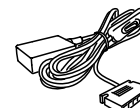

ANSLUTA for ON/OFF function

Smart solution

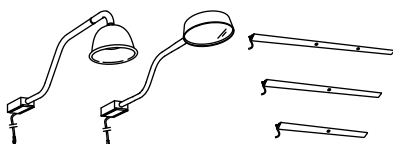

TVÄRDAG, YTBERG or ÖVERSIDAN

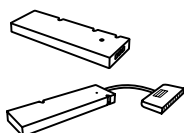

TRÅDFRI LED driver

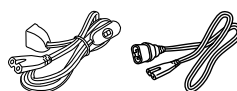

ANSLUTA power supply cord and intermediate connection cord.



STYRBAR remote control and RODRET wireless dimmer for more lights function



DIRIGERA hub

See All parts and prices list for more information about each product.

How to choose a driver

There are two LED drivers. Choose based on how many units you want to connect. For the 10W driver you can connect up to three units, as long as the total wattage does not exceed 10W. The 30W LED driver can support up to nine units, max. wattage 30W. You can connect up to 10 drivers in one installation cord. Flashing lights indicate that the maximum wattage of the LED

driver is exceeded. If you want to use more than one LED driver, make sure to synchronize each LED driver with the STYRBAR remote control or RODRET wireless dimmer so that the entire combination can be dimmed at the same time. Make your cabinet lighting smart by adding the DIRIGERA hub and IKEA Home smart app..

On/off function

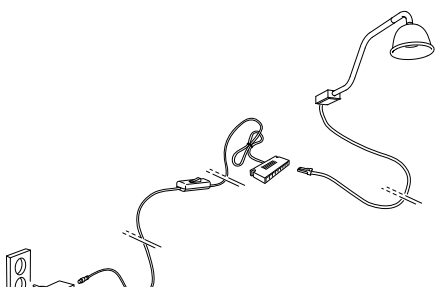

Dimming function

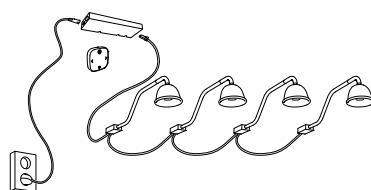

You can connect up to six lamps to TRÅDFRI driver, 10W.

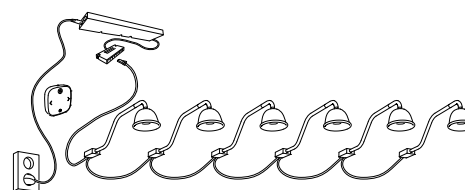

You can connect up to 18 lamps to TRÅDFRI driver, 30W, but max. six lamps in each group.

How to build integrated lighting

ÖVERSIDAN lighting strips

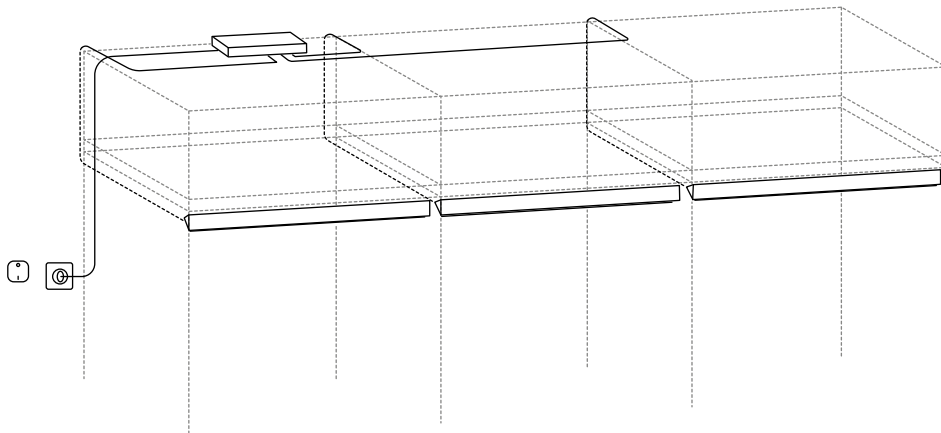

Cabinet lighting

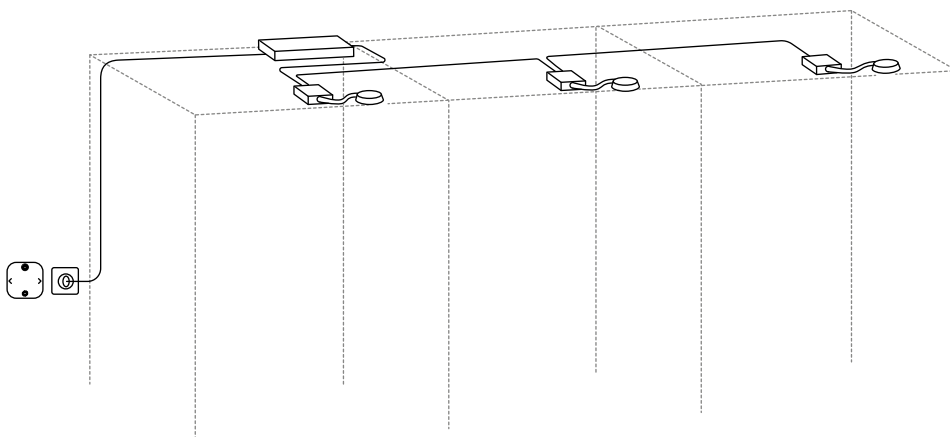

ÖVERSIDAN and cabinet lighting with smart lighting remote

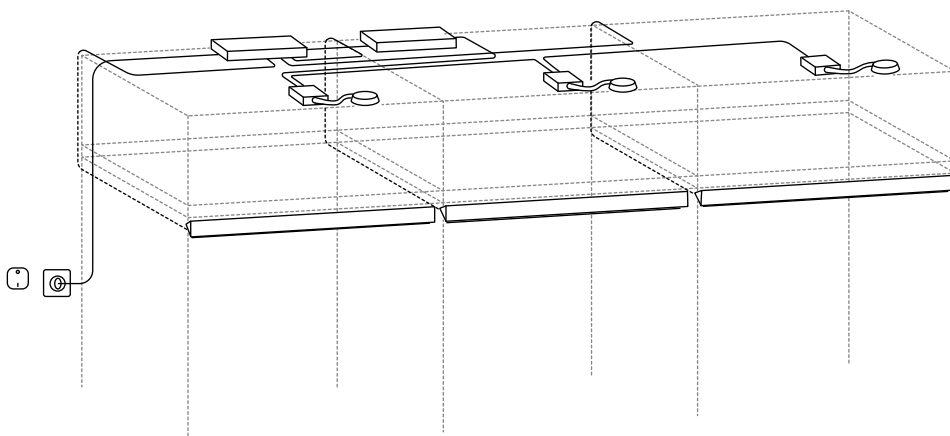

Integrated lighting solutions – combination examples

Here you can find some integrated lighting solutions for the PAX wardrobe. In these solutions we placed the ÖVERSIDAN lighting strips to help you to find everything you are looking for

in your beautiful new wardrobe. Remember that you can personalize your lighting solution based on your personal needs.

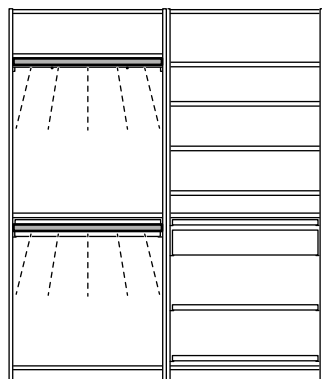

PAX Combination, total size: W78¾×D17⅝×H93⅝".
Complete the combination with

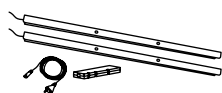

ÖVERSIDAN/TRÅDFRI Lighting kit	
White	694.422.32
Beige	595.632.72
Dark gray	794.429.05

Parts included in this lighting kit:

ÖVERSIDAN LED wardrobe lighting strip with sensor, 38", dimmable	2 pcs
TRÅDFRI Driver for wireless control, 10W	1 pc
ANSLUTA Power supply cord, 11'6"	1 pc

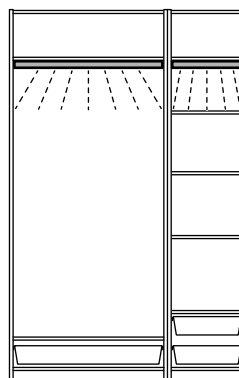

PAX Combination, total size: W59×D23⅝×H93⅝".
Complete the combination with

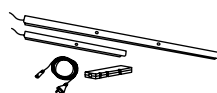

ÖVERSIDAN/TRÅDFRI Lighting kit	
White	294.427.57
Beige	194.423.24
Dark gray	494.423.13

Parts included in this lighting kit:

ÖVERSIDAN LED wardrobe light strip with sensor, 18", dimmable	1 pc
ÖVERSIDAN LED wardrobe light strip with sensor, 38", dimmable	1 pc
TRÅDFRI Driver for wireless control, 10W	1 pc
ANSLUTA Power supply cord, 11'6"	1 pc

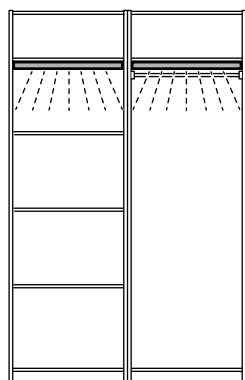

PAX combination, total size: W59×D23⅝×H93⅝".
Complete the combination with

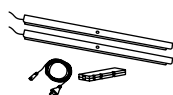

ÖVERSIDAN/TRÅDFRI Lighting kit	
White	494.427.80
Beige	894.427.97
Dark gray	394.428.08

Parts included in this lighting kit:

ÖVERSIDAN LED wardrobe strip with sensor, 28", dimmable	2 pcs
TRÅDFRI Driver for wireless control, 10W	1 pc
ANSLUTA Power supply cord, 11'6"	1 pc

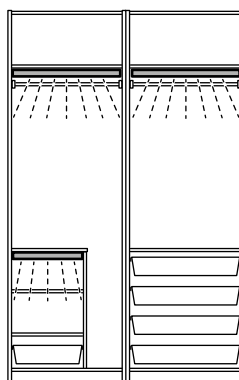

PAX Combination, total size: W59×D26×H93⅝".
Complete the combination with

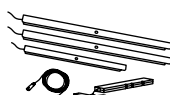

ÖVERSIDAN/TRÅDFRI Lighting kit	
White	494.428.22
Beige	494.428.36
Dark gray	395.632.92

Parts included in this lighting kit:

ÖVERSIDAN LED wardrobe strip with sensor, 28", dimmable	2 pcs
ÖVERSIDAN LED wardrobe strip with sensor, 18", dimmable	1 pc
TRÅDFRI Driver for wireless control, 30W	1 pc
ANSLUTA Power supply cord, 11'6"	1 pc

Integrated lighting solutions – combination examples

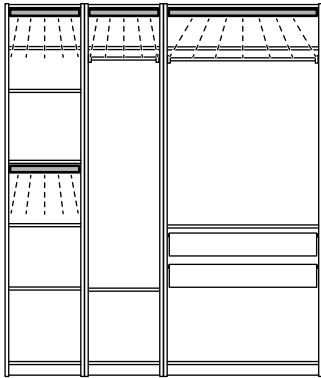

PAX Combination, total size: W78¾×D23⅝×H93⅜".
Complete the combination with

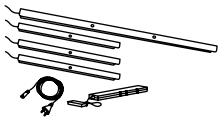

ÖVERSIDAN/TRÅDFRI Lighting kit

White	795.634.69
Beige	295.633.15
Gray	094.428.76

Parts included in this lighting kit:

ÖVERSIDAN LED wardrobe light strip with sensor, 18", dimmable	3 pcs
ÖVERSIDAN LED wardrobe light strip with sensor, 38", dimmable	1 pc
TRÅDFRI driver for wireless control, 30W	1 pc
ANSLUTA Power supply cord, 11'6"	1 pc

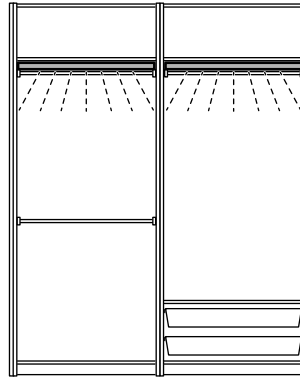

PAX Combination, total size: W78¾×D23⅝×H93⅜".
Complete the combination with

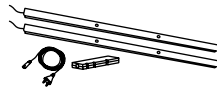

ÖVERSIDAN/TRÅDFRI lighting kit.

White	694.422.32
Beige	595.632.72
Dark gray	794.429.05

Parts included in this lighting kit:

ÖVERSIDAN LED wardrobe strip with sensor, 38", dimmable	2 pcs
TRÅDFRI Driver for wireless control, 10W	1 pc
ANSLUTA Power supply cord, 11'6"	1 pc

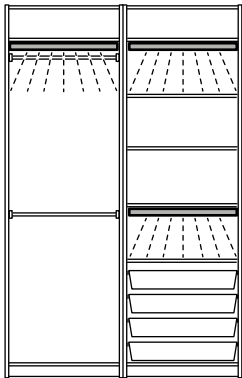

PAX Combination, total size: W59×D26×H93⅜".
Complete the combination with

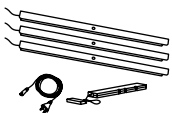

ÖVERSIDAN/TRÅDFRI Lighting kit

White	994.429.33
Beige	394.429.74
Dark gray	294.429.60

Parts included in this lighting kit:

ÖVERSIDAN LED wardrobe strip with sensor, 28", dimmable	3 pcs
TRÅDFRI Driver for wireless control, 10W	1 pc
ANSLUTA Power supply cord, 11'6"	1 pc

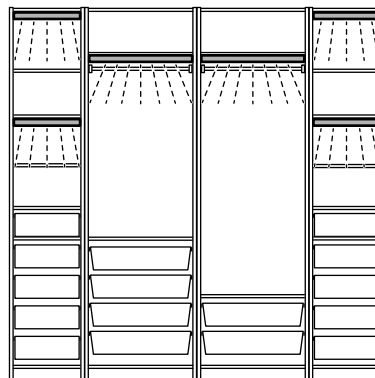

PAX combination, total size: W98¾×D26×H93⅜".
Complete the combination with

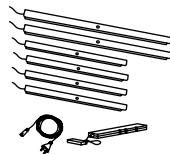

ÖVERSIDAN/TRÅDFRI lighting kit.

White	594.429.87
Beige	995.634.92
Dark gray	295.635.13

Parts included in this lighting kit:

ÖVERSIDAN LED wardrobe strip with sensor, 28", dimmable	2 pcs
ÖVERSIDAN LED wardrobe strip with sensor, 18", dimmable	4 pcs
TRÅDFRI Driver for wireless control, 30W	1 pc
ANSLUTA Power supply cord, 11'6"	1 pc

Over the cabinet lighting

TVÄRDRAG and YTBERG are cabinet's best friend – it lights things up and spread a soft light that create a cozy atmosphere in the room. It also provides a focused light that

is good for lighting smaller areas. Use it on top of a wardrobe in the bedroom, or together with storage in the living room, kitchen or hallway.

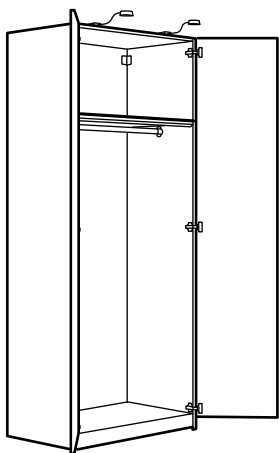

YTBERG Combination.

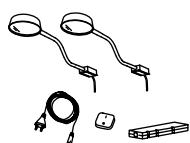

YTBERG/TRÅDFRI Lighting kit

Black	394.946.75
White	094.947.09

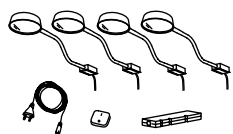

YTBERG/TRÅDFRI lighting kit.

Black	595.203.91
White	794.947.20

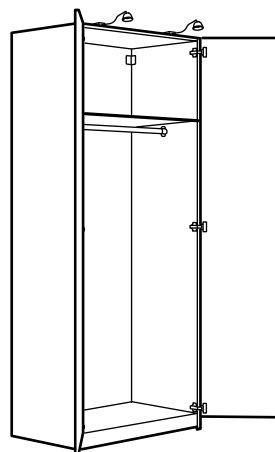

TVÄRDRAG Combination

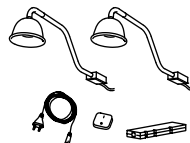

TVÄRDRAG/TRÅDFRI Lighting kit

Black	094.947.33
-------	------------

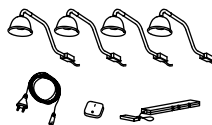

TVÄRDRAG/TRÅDFRI Lighting kit

Black	894.950.74
-------	------------

SERVICES

IKEA products are designed to be taken home and assembled by you. That way, you'll save the most money. But if you would like some help, we can offer a range of services. Assembly and delivery services are fulfilled by an Independent Service Provider. Contact your local IKEA store or visit the IKEA website for details: [IKEA-USA.com/services](https://www.IKEA-USA.com/services)



DELIVERY SERVICE

Most of our products are designed and packaged so that you can take them home yourself. If you prefer, we can arrange for delivery of your purchases directly to your home or business. Same day, next day or same week deliveries are available. We can also arrange for delivery at a later date if you would like.



TASKRABBIT ASSEMBLY SERVICE

All IKEA products are designed to be assembled by you, but you don't have to. We've partnered with TaskRabbit to connect you with a network of independent 'Taskers' who can provide quick and convenient assembly and mounting services for your IKEA purchases made online and in stores. You can schedule assembly service for as soon as the same day, with the Tasker of your choice. Visit [TaskRabbit.com/IKEA](https://www.TaskRabbit.com/IKEA) or see a co-worker for more details.

Services and prices may vary, please see [IKEA-USA.com/services](https://www.IKEA-USA.com/services) or talk to us in your local IKEA store.



IKEA Projekt Credit Card

Your dream home is now within reach and more affordable than ever. With the IKEA Projekt Credit Card*, you don't have to put off loving every room in your home.

*Credit card offers are subject to approval.

IKEA Projekt Credit Card Accounts are issued by Comenity Capital Bank.

To learn more visit [IKEA-USA.com/creditcard](https://www.IKEA-USA.com/creditcard) or drop by your local IKEA store.