

TRÅDFRI

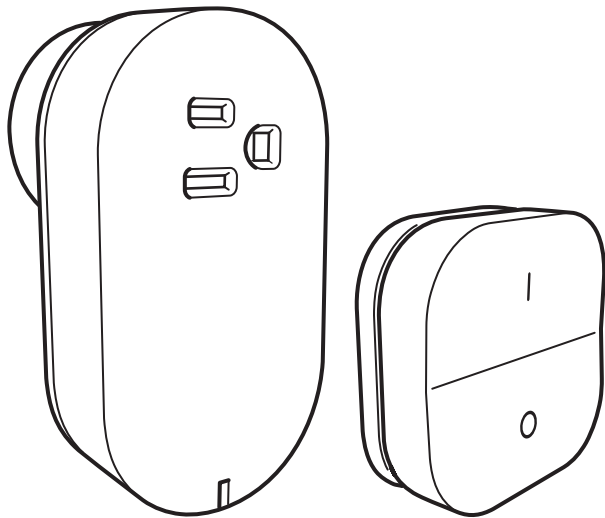

Design and Quality
IKEA of Sweden



English

IMPORTANT SAFETY INSTRUCTIONS

For indoor use only.

Regularly check the cord, the transformer and all other parts for damage. If any part is damaged the product should not be used.

Important information! Keep these instructions for future use.

English

Different materials require different types of fittings. Always choose screws and plugs that are specially suited to the material.

English

ATTENTION:

CAUTION:

Injury to persons and damage to the lamp and/or the mounting surface may result if the lamp is pulled from the surface. To reduce the likelihood of such injury or damage, mount only on a surface that is mechanically sound.

English

WARNING

Deviation from the assembly instructions may result in a risk of fire or electric shock.

English

This device complies with part 15 of the FCC Rules. Operation is subjected to the following two conditions:

1. This device may not cause harmful interference, and
2. this device must accept any interference received, including interference that may cause undesired operation.

WARNING

Changes or modifications not expressly approved by the party responsible for compliance could void the user's authority to operate the equipment.



Français

INSTRUCTIONS DE SECURITE IMPORTANTES

Pour une utilisation à l'intérieur uniquement.

Vérifier régulièrement le câble, le transformateur et toutes les pièces pour vous assurer qu'ils ne sont pas endommagés. Ne pas utiliser le produit si une pièce est endommagée. Information importante. A conserver pour pouvoir s'y reporter ultérieurement.

Français

Le choix des vis dépend du matériau dans lequel elles doivent être fixées. Utiliser des vis et chevilles adaptées au matériau du support.

Français

IMPORTANT!

MISE EN GARDE

Ne pas arracher le luminaire. Cela peut provoquer des blessures ou l'endommagement du luminaire ou du support auquel il est fixé. Pour des raisons de sécurité, fixer le luminaire à une surface solide et adaptée.

Français

ATTENTION

Tout écart par rapport aux instructions d'assemblage peut entraîner un risque d'incendie ou de choc électrique.

Français

Cet appareil est conforme à la partie 15 des règles de la FCC. Son fonctionnement est soumis aux deux conditions suivantes :

1. Cet appareil ne doit pas provoquer de brouillage préjudiciable et
2. il doit accepter tout brouillage reçu, y compris le brouillage pouvant entraîner un mauvais fonctionnement.

ATTENTION:

Tout changement apporté à cet appareil non expressément approuvé par la partie responsable de la conformité est susceptible d'annuler le droit de l'utilisateur à se servir de cet équipement.



Español

INSTRUCCIONES DE SEGURIDAD IMPORTANTES

Utilizar solo en el interior.

Comprueba regularmente el cable, el transformador y todas las piezas para asegurarte de que no están dañados. No utilizar el producto si hubiera alguna pieza dañada. Información importante. Guardar estas instrucciones para consulta en el futuro.

Español

Diferentes materiales requieren diferentes clases de herrajes. Recuerda que los tornillos y tacos que elijas se deben adaptar al material en el que irán sujetos.

Español

¡ATENCIÓN! ¡ADVERTENCIA!

No extraer la lámpara de la superficie de montaje. Esto puede ocasionar daños a las personas, a la lámpara y/o a la superficie de montaje. Para reducir el riesgo de daños, la lámpara sólo se debe montar en una superficie adecuada y resistente.

Español

ADVERTENCIA

No seguir las instrucciones de montaje puede resultar en incendio o descarga eléctrica.

Español

Este aparato cumple la parte 15 de las normas FCC. Su funcionamiento está sujeto a las dos condiciones siguientes:

1. Este aparato no debe provocar interferencias perjudiciales.
2. Debe aceptar cualquier interferencia que reciba, incluidas las interferencias que puedan suponer un mal funcionamiento.

ATENCIÓN:

Cualquier cambio o modificación que se realice sin ser aprobado expresamente por la parte responsable de la conformidad, es susceptible de anular el derecho del usuario a utilizar este equipo.

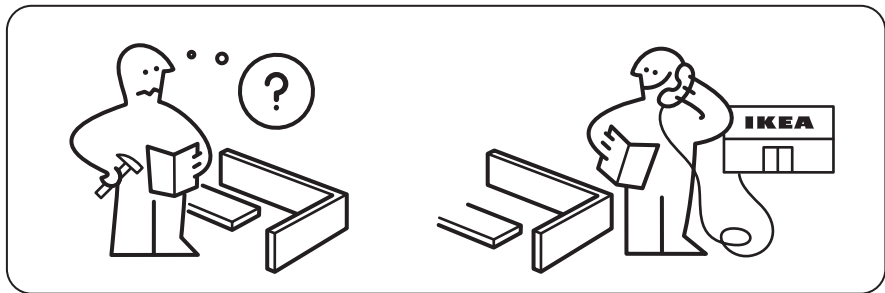
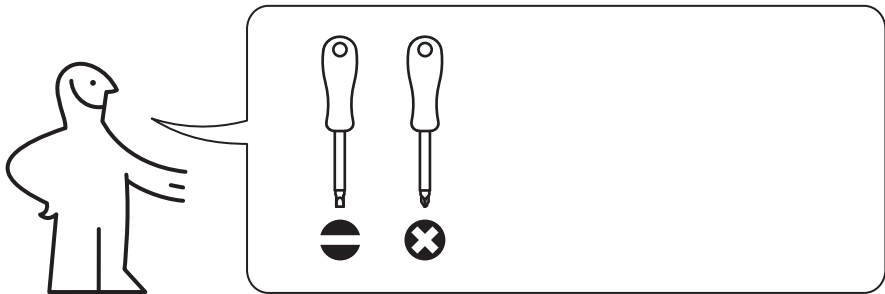

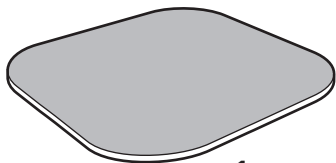

1x

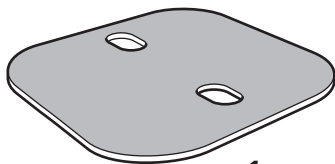

190011

1x

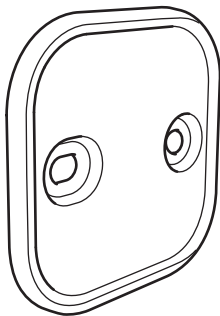

190013

1x

1

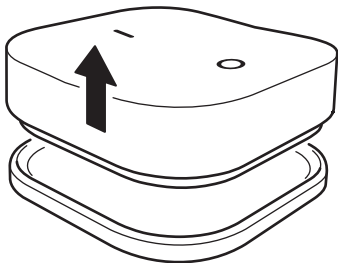

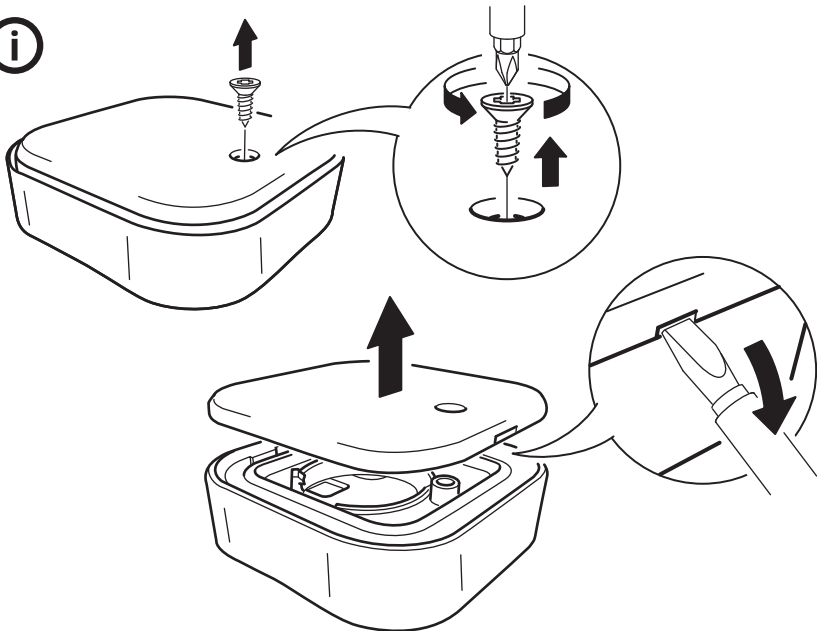

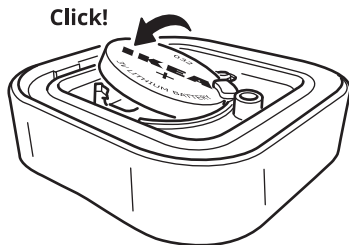
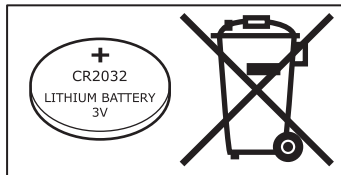



English

Keep battery out of childrens reach. To swallow a battery could be fatal. If this happens seek medical attention at once. Before disposal always cover the battery in plastic tape to avoid possible short circuit.

SAVE THESE INSTRUCTIONS.

Français

Gardez la pile hors de portée des enfants. Avaler une pile peut être fatal. Si cela se produit, appelez immédiatement un médecin. Avant de mettre la pile au rebut, couvrez-la d'une bande plastique pour éviter tout court-circuit.

CONSERVER CES INSTRUCTIONS

Español

Mantén la pila fuera del alcance de los niños. Ingerir una pila podría ser fatal. En caso de que suceda, acude inmediatamente al médico. Antes de desecharla cubre la pila con plástico para evitar cortocircuitos.

GUARDA ESTAS INSTRUCCIONES.

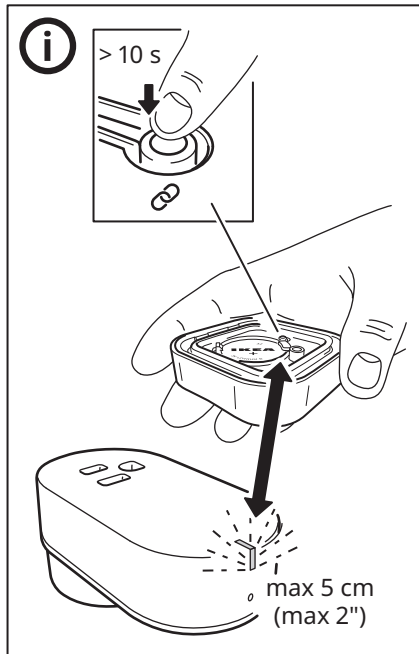
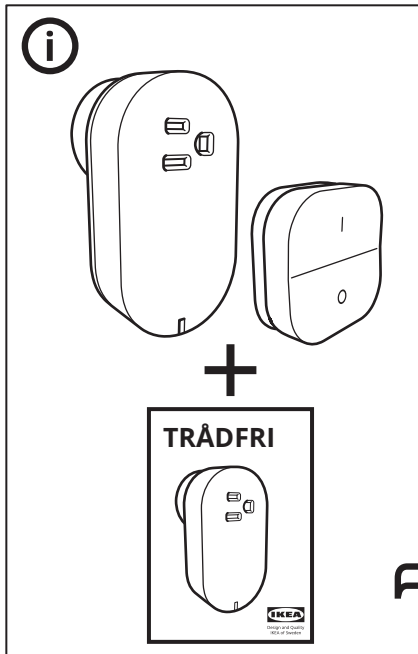

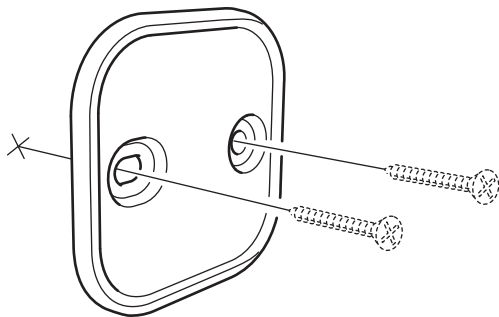
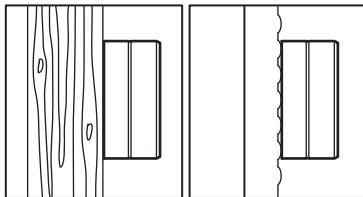

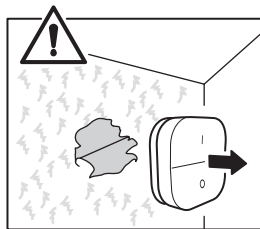
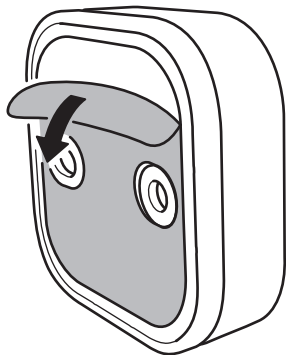
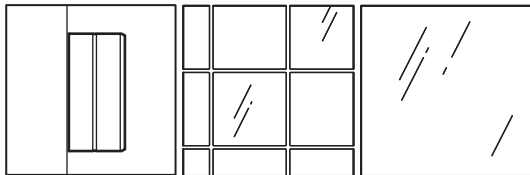

23

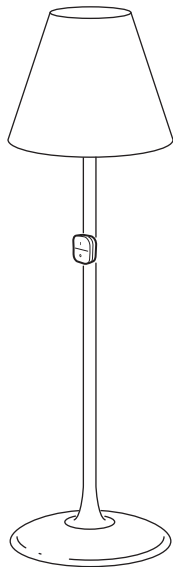
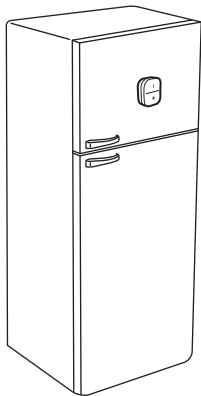
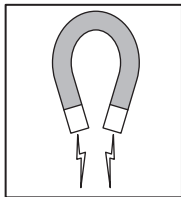

2

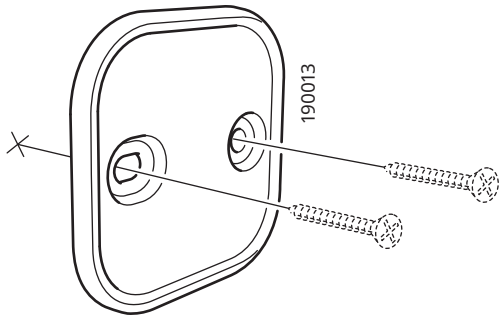
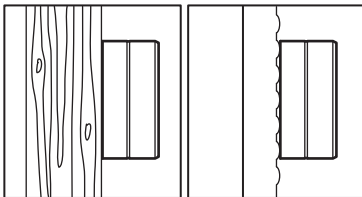

3

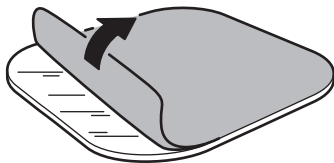

4

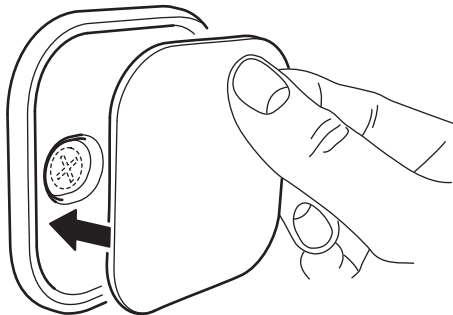

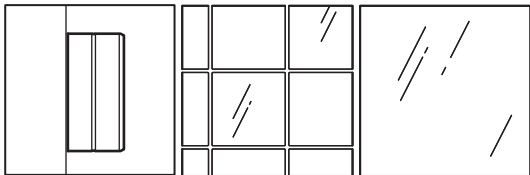

2

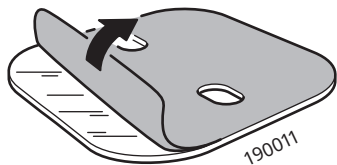

3

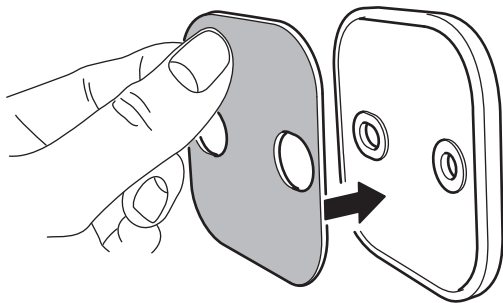

4

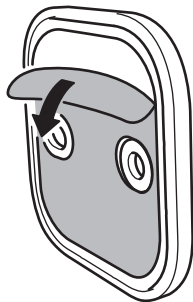

5

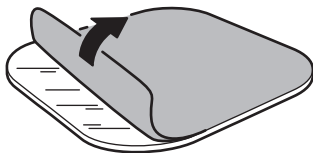

6

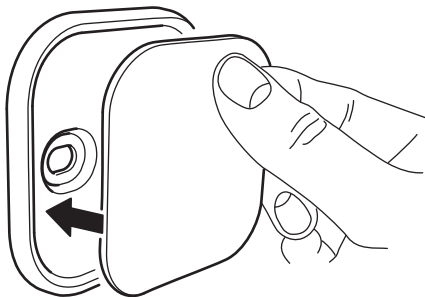

7

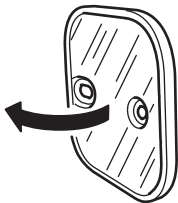
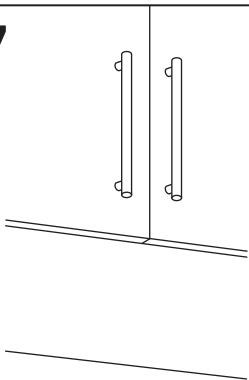

8

