

LAGAN



Design and Quality
IKEA of Sweden



Please refer to **www.IKEA.com** and select your local store for local store phone numbers and opening time.

Contents

| | | | |
|---------------------|----|------------------------|----|
| Safety information | 4 | Daily use | 15 |
| Safety instructions | 6 | Hints and tips | 17 |
| Product description | 8 | Care and cleaning | 18 |
| Control panel | 9 | Troubleshooting | 20 |
| Programmes | 10 | Technical information | 23 |
| Options | 11 | Environmental concerns | 25 |
| Settings | 12 | IKEA warranty | 25 |
| Before first use | 13 | | |

Subject to change without notice.

Safety information

Before the installation and use of the appliance, carefully read the supplied instructions. The manufacturer is not responsible for any injuries or damages that are the result of incorrect installation or usage. Always keep the instructions in a safe and accessible location for future reference.

Children and vulnerable people safety

- This appliance can be used by children aged from 8 years and above and persons with reduced physical, sensory or mental capabilities or lack of experience and knowledge if they have been given supervision or instruction concerning the use of the appliance in a safe way and understand the hazards involved.
- Children between 3 and 8 years of age and persons with very extensive and complex disabilities shall be kept away unless continuously supervised.
- Children of less than 3 years of age should be kept away unless continuously supervised.
- Do not let children play with the appliance.
- Keep detergents away from children.
- Keep children and pets away from the appliance when the door is open.

- Children shall not carry out cleaning and user maintenance of the appliance without supervision.
- Keep all packaging away from children and dispose of it appropriately.

General Safety

- This appliance is intended to be used in household and similar applications such as:
 - Farm houses; staff kitchen areas in shops, offices and other working environments;
 - By clients in hotels, motels, bed and breakfast and other residential type environments.
- Do not change the specification of this appliance.
- The operating water pressure (minimum and maximum) must be between 0.4 (0.04) / 10 (1.0) bar (MPa).
- Obey the maximum number of 10 place settings.
- When positioning the appliance, ensure the supply cord is not trapped or damaged.
- If the supply cord is damaged, it must be replaced by the manufacturer, its Authorised Service Centre or similarly qualified persons in order to avoid a hazard.
- Keep ventilation openings, in the appliance enclosure or in the built-in structure, clear of obstruction.
- Put the cutlery in the cutlery basket with the sharp ends pointing down or put them in the cutlery rack in a horizontal position with the sharp edges down.
- Do not leave the appliance with the open door unattended to avoid stepping accidentally onto it.
- Before any maintenance operation, deactivate the appliance and disconnect the mains plug from the socket.
- Do not use high pressure water sprays and/or steam to clean the appliance.
- If the appliance has ventilation openings in the base, they must not be covered e.g. by a carpet.

- The appliance is to be connected to the water mains using the new supplied hose-sets. Old hose sets must not be reused.

Safety instructions

Installation

- ⚠ **Warning!** Only a qualified person can install this appliance.
- Remove all the packaging and the transit bolts.
- Do not install or use a damaged appliance.
- Do not install or use the appliance where the temperature is less than 0 °C.
- Follow the installation instruction supplied with the appliance.
- Always take care when moving the appliance as it is heavy. Always use safety gloves and enclosed footwear.
- Make sure that the appliance is installed below and adjacent to safe structures.

Electrical connection

- ⚠ **Warning!** Risk of fire and electrical shock.
- ⚠ **Warning!** When positioning the appliance, ensure the supply cord is not trapped or damaged.
- ⚠ **Warning!** Do not use multi-plug adapters and extension cables.
- ⚠ **Warning!** Do not, under any circumstances, cut, remove, or bypass the grounding prong
- The appliance must be earthed.
- Make sure that the parameters on the rating plate are compatible with the electrical ratings of the mains power supply.
- Always use a correctly installed shockproof socket.
- Make sure not to cause damage to the electrical components (e.g. mains plug, mains cable). Contact the Authorised Service Centre to change the electrical components.
- Connect the mains plug to the mains socket only at the end of the installation. Make sure that there is access to the mains plug after the installation.
- Do not pull the mains cable to disconnect the appliance. Always pull the mains plug.
- This appliance complies with the E.E.C. Directives.

- UK and Ireland only. This appliance is fitted with a 13 A mains plug. If it is necessary to change the mains plug fuse, use only a 13 A ASTA (BS 1362) fuse.

Water connection

- Do not cause damage to the water hoses.
- Before connection to new pipes, pipes not used for a long time, where repair work has been carried out or new devices fitted (water meters, etc.), let the water flow until it is clean and clear.
- Ensure that there are no visible water leaks during and after the first use of the appliance.
- The water inlet hose has a safety valve and a sheath with an inner mains cable.



- ⚠ **Warning!** Dangerous voltage.
- If the water inlet hose is damaged, immediately close the water tap and disconnect the mains plug from the mains socket. Contact the Authorised Service Centre to replace the water inlet hose.

Use

- ⚠ **Warning!** Risk of injury, burns, electrical shock or fire.
- Do not sit or stand on the open door.
- Dishwasher detergents are dangerous. Obey the safety instructions on the detergent packaging.
- Use only detergent and rinse aid recommended for use in an automatic dishwasher.

- Never use soap, laundry detergent, or hand washing detergent in your dishwasher.
- Dishwasher detergent is corrosive! Keep dishwasher detergent out of the reach of children.
- Do not drink and play with the water in the appliance.
- Do not remove the dishes from the appliance until the programme is complete. Some detergent may remain on the dishes.
- The appliance can release hot steam if you open the door while a programme operates.
- Do not put flammable products or items that are wet with flammable products in, near or on the appliance.

Service

- To repair the appliance contact an Authorised Service Centre.
- Use original spare parts only.

Disposal

 **Warning!** Risk of injury or suffocation.

- Disconnect the appliance from the mains supply.
- Cut off the mains cable and discard it.
- Remove the door to prevent children and pets to be closed inside of the appliance.

Product description

Product overview

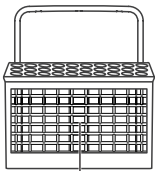
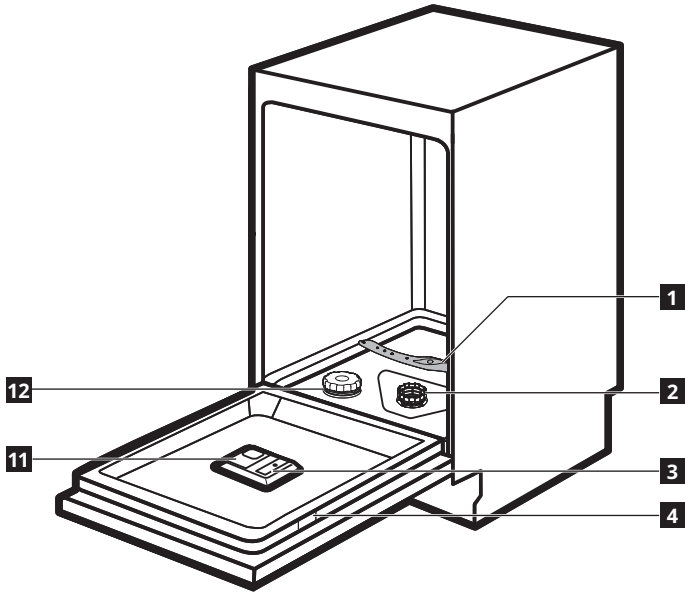

10

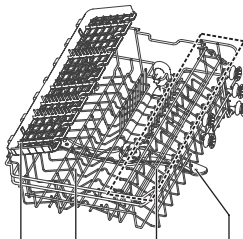

9

8

7

6



5

- 1 Lower spray arm
- 2 Filters
- 3 Rinse aid dispenser
- 4 Rating plate
- 5 Lower basket
- 6 Upper spray arm

- 7 Cup shelf
- 8 Upper basket
- 9 Cutlery rack
- 10 Cutlery basket
- 11 Detergent dispenser
- 12 Salt container

Control panel

Control panel

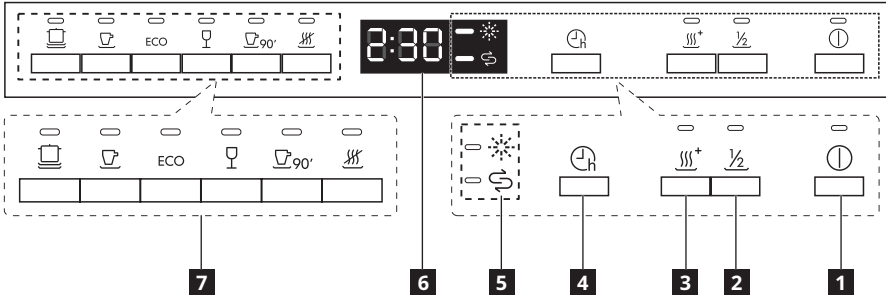





- 1** On/off button
- 2** Half-load wash button
- 3** Dry plus button
- 4** Delay button
- 5** Indicators
- 6** Display
- 7** Programme buttons

Indicators





| Indicators | Description |
|------------|---|
| | Rinse aid indicator. It is always off while a programme operates. |
| | Salt indicator. It is always off while a programme operates. |

Programmes

| Programme | Degree of soil Type of load | Programme phases | Options |
|---|--|--|--|
|  (Intensive) | <ul style="list-style-type: none"> • Heavy soil • Crockery, cutlery, pots and pans | <ul style="list-style-type: none"> • Prewash (50 °C) • Wash (65 °C) • Rinse • Rinse • Rinse (65 °C) • Drying | <ul style="list-style-type: none"> • Half-load wash • Dry plus |
|  (Universal) | <ul style="list-style-type: none"> • All • Crockery, cutlery, pots and pans | <ul style="list-style-type: none"> • Prewash (45 °C) • Wash (55 °C) • Rinse • Rinse (65 °C) • Drying | <ul style="list-style-type: none"> • Half-load wash • Dry plus |
| ECO (ECO) ¹⁾ | <ul style="list-style-type: none"> • Normal soil • Crockery and cutlery | <ul style="list-style-type: none"> • Wash (45 °C) • Rinse • Rinse (60 °C) • Drying | <ul style="list-style-type: none"> • Half-load wash • Dry plus |
|  (Glass) | <ul style="list-style-type: none"> • Light soil • Delicate crockery and glassware | <ul style="list-style-type: none"> • Prewash • Wash 50 °C • Rinse • Rinse (65 °C) • Dry | <ul style="list-style-type: none"> • Half-load wash • Dry plus |
|  90' (90 minutes) | <ul style="list-style-type: none"> • Normal soil • Crockery and cutlery | <ul style="list-style-type: none"> • Wash 60 °C • Rinse • Rinse (65 °C) • Dry | <ul style="list-style-type: none"> • Half-load wash • Dry plus |
|  (Rapid) | <ul style="list-style-type: none"> • Fresh soil • Crockery and cutlery | <ul style="list-style-type: none"> • Wash 50 °C • Rinse • Rinse (45 °C) | |

1) With this programme you have the most efficient use of water and energy consumption for crockery and cutlery with normal soil. (This is the standard programme for test institutes).

Consumption values

| Programme ¹⁾ | Detergent Pre/ Main wash | Water (l) | Energy (kWh) | Duration (min) |
|---|-----------------------------|-----------|--------------|-------------------|
|  (Intensive) | 5/20 g | 15,3 | 1,378 | 205 |
|  (Universal) | 5/20 g | 13,1 | 1,287 | 175 |
| ECO (ECO) | 25 g | 9,0 | 0,741 | 235 |
|  (Glass) | 5/20 g | 13,1 | 0,934 | 120 |
|  90' (90 minutes) | 5/20 g | 10,2 | 1,234 | 90 |
|  (Rapid) | 15 g | 10,0 | 0,611 | 30 |

1) The pressure and the temperature of the water, the variations of the mains supply, the options and the quantity of dishes can change the values.



Information for test institutes

To receive the necessary information for conducting performance tests (e.g. according to EN50242), send an email to:

info.dishwasher@meicloud.com

In your request please include the product number code (PNC) found on the rating plate.



Options

-  Desired options must be activated every time before you start a programme. It is not possible to activate or deactivate options while a programme is running.
-  If an option is not applicable to a programme, the related indicator is off or it flashes quickly for a few seconds and then goes out.
-  Activating options can affect the water and energy consumption as well as the programme duration.

Half-load wash function

Select this option to save water and energy consumption if you have only a few items to be washed. The maximum capacity is 10 places. It is recommended to use less detergent than for a full load.



How to activate half-load wash function

Press .
The related indicator is on.
The display shows the updated programme duration.
The half-load wash function is not applicable to the  (Rapid wash) programme.

Dry plus function

Activate this option to boost the drying performance.
The combination of dry plus and rinse aid ensures even better drying results.

How to activate dry plus function

Press .
The related indicator is on.
The display shows the updated programme duration.
The dry plus function is not applicable to the  (Rapid wash) programme.

Settings

The water softener

The water softener removes minerals from the water supply, which would have a detrimental effect on the washing results and on the appliance.

The higher the content of these minerals, the harder your water is. Water hardness is measured in equivalent scales.

The water softener should be adjusted according to the hardness of the water in your area. Your local water authority can advise you on the hardness of the water in your area. It is important to set the right level of the water softener to assure good washing results.

Water hardness

| German degrees (°dH) | French degrees (°fH) | mmol/l | Clarke degrees | Water softener level | Salt consumption (gram/cycle) |
|----------------------|----------------------|-----------|----------------|----------------------|-------------------------------|
| 35 - 55 | 61 - 98 | 6,1 - 9,8 | 43 - 69 | H6 | 60 |
| 23 - 34 | 41 - 60 | 4,1 - 6,0 | 29 - 42 | H5 | 30 |
| 18 - 22 | 31 - 40 | 3,1 - 4,0 | 22 - 28 | H4 | 20 |
| 12 - 17 | 21 - 30 | 2,1 - 3,0 | 15 - 21 | H3 ¹⁾ | 12 |
| 6 - 11 | 10 - 20 | 1,0 - 2,0 | 7 - 14 | H2 | 9 |
| 0 - 5 | 0 - 9 | 0 - 0,94 | 0 - 6 | H1 ²⁾ | 0 |

1) Factory setting.



2) Do not use salt at this level.

4. Press the on/off button to confirm the setting.

Whether you use a standard detergent or multi-tabs (with or without salt), set the proper water hardness level to keep the salt refill notification active.

 Multi-tabs containing salt are not effective enough to soften hard water.

How to set the water softener level

1. Press the on/off button to switch the appliance on.
2. Within 60 seconds after the appliance is switched on, press and hold  for more than 5 seconds to enter water softener setting mode.
3. Press  repeatedly to toggle the following water softener levels on the display: H1 - H2 - H3 - H4 - H5 - H6

The rinse aid empty notification

The rinse aid helps to dry the dishes without streaks and stains. For best drying performance, always use rinse aid.

The rinse aid is automatically released during the hot rinse phase.



When rinse aid chamber is empty, the rinse aid indicator is turned on notifying to refill rinse aid.

The rinse aid level

It is possible to set the released quantity of rinse aid between "D1" level (minimum quantity) and "D5" level (maximum quantity).

How to set the rinse aid level

1. Press the on/off button to switch the appliance on.

2. Within 60 seconds after the appliance is switched on, press and hold  for more than 5 seconds and then press  to enter rinse aid setting mode.
The rinse aid indicator flashes.
3. Press  repeatedly to toggle the following rinse aid levels on the display:
D1 - D2 - D3 - D4 - D5
The higher the number, the more rinse aid released by the appliance.
4. Press the on/off button to confirm the setting.

Before first use

1. **Make sure that the current level of the water softener agrees with the hardness of the water supply. If not, adjust the level of the water softener.**
2. Fill the salt container.
3. Fill the rinse aid dispenser.
4. Open the water tap.
5. Start a programme to remove any processing residuals that can still be inside the appliance. Do not use detergent and do not load the baskets.

 After starting a programme, it may take up to 5 minutes for the appliance to recharge the resin in the water softener. It seems that the appliance is not working. The washing phase starts only after this procedure is completed. The procedure is repeated periodically.

The salt container

 **Caution!** Use rough salt designed for dishwashers only. Fine salt increases the risk of corrosion.

The salt is used to recharge the resin in the water softener and to assure good washing results in daily use.

Filling the salt container

i Fill the salt only when the salt indicator turns on.

1

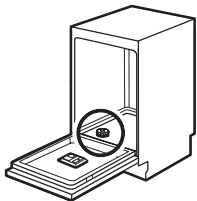

Find the salt container at the bottom.

2

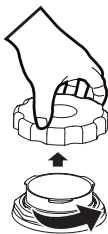

Remove the cap of the salt container.

3



Fill the salt container to the maximum level with water.

4

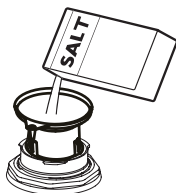

Place the supplied funnel over the mouth of the salt container, then put 1.5 kg of salt in the container.

5

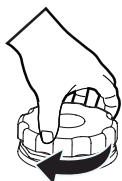

Tightly close the tap of the salt container.

⚠ Caution! Water and salt may come out of the salt container when you fill it. After you fill the salt container, immediately start a programme to prevent corrosion.

Filling the rinse aid dispenser

1

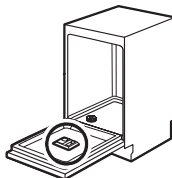

Find the rinse aid dispenser on the inside of the door.

2

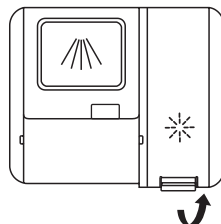

Raise the cover of the rinse aid container.

3

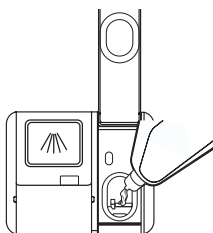

Fill the rinse aid container with rinse aid. Be careful not to overfill.

4

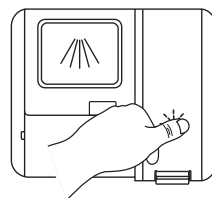

Close the cover of the rinse aid container.

Daily use

1. Open the water tap.
2. Press the on/off button to activate the appliance.
 - If the salt indicator is on, fill the salt container.
 - If the rinse aid indicator is on, fill the rinse aid dispenser.
3. Load the baskets.
4. Add the detergent.
5. Set and start the correct programme for the type of load and the degree of soil.

Using the detergent

1

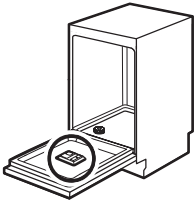

Find the detergent dispenser on the inside the door.

2

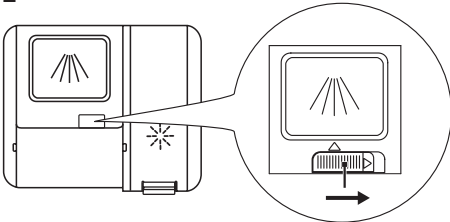

Slide the release catch to right, then open the cap of the detergent dispenser

3

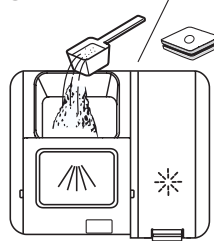

Add the detergent (powder or multi-tabs) in the detergent dispenser.

4

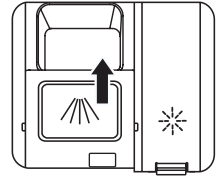

Close the cap by sliding it forward then pressing it down.

5

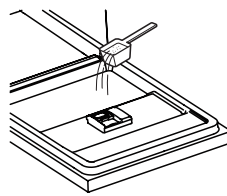

If the programme has a prewash phase, put a small quantity of detergent on the inner part of the appliance door.

Setting and starting a programme

The Auto Off function

This function decreases energy consumption by automatically deactivating the appliance when it is not operating.

The function comes into operation:

- 15 minutes after the completion of the programme.
- After 15 minutes if the programme has not started.

Starting a programme

⚠ Caution! Do not remove the baskets from the dishwasher before a wash cycle.

1. Keep the appliance door ajar.
2. Press the on/off button to activate the appliance.
3. To select a desired programme, press the related programme button.
The related programme indicator is on. The display shows the programme duration.
4. Set the applicable options.
5. Close the appliance door to start the programme.

Starting a programme with delay start

1. Set a programme.
2. Press  repeatedly until the display shows the delay time you want to set (from 1 to 24 hours). The delay indicator comes on.
3. Close the appliance door to start the countdown.

While a countdown is running it is possible to increase the delay time but not to change the selection of the programme and options.

When the countdown is completed, the programme starts.

Opening the door while the appliance operates

Opening the door while a programme is running stops the appliance. It may affect the energy consumption and the programme duration. After closing the door, the appliance continues from the point of interruption.

Cancelling the delay start while the countdown operates

When you cancel the delay start you have to set the programme and options again.

Press the on/off button to deactivate the appliance. The delay start will be cancelled.

Cancelling the programme

Press the on/off button to deactivate the appliance.

Or open the door to stop running the programme, and wait a few seconds until the appliance completely stops, then press the on/off button. The programme will be cancelled. Make sure that there is detergent in the detergent dispenser before you start a new programme.

End of the programme

1. Press the on/off button or wait for the Auto Off function to automatically deactivate the appliance. If you open the door before the activation of Auto Off, the appliance is automatically deactivated.
2. Close the water tap.

When the programme is completed the display shows 0:00.

All buttons are inactive except for the on/off button.

Positioning the upper basket

The upper basket can be re-positioned at different heights to permit storage of dishes of various sizes.

1. Slide the upper basket out of the appliance.

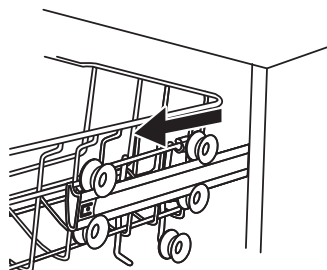

2. Re-attach the upper basket onto the upper or lower rollers.

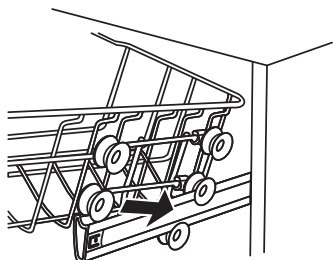

3. Slide the upper basket in.

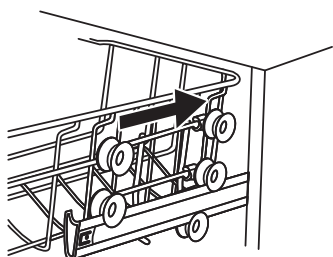

Adjustable cup shelf

The cup shelf in the upper basket can be unfolded to make room for taller dishes.

1. Pull the cup shelf up to unfold it.

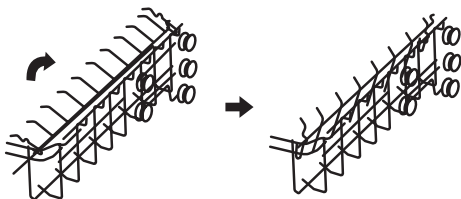

2. To fold the cup shelf, push it down.

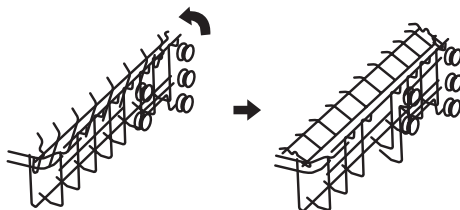

Adjustable lower basket

The spikes of the lower basket can be folded to make room for large dishes.

1. Push the spikes of the lower basket down to fold the spikes.

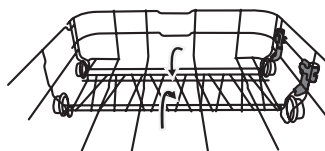

2. To unfold the spikes of the lower basket, pull it up.

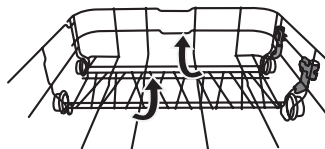

Hints and tips

General

The following hints will ensure optimal cleaning and drying results in daily use and also help to protect the environment.

- Remove larger residues of food from the dishes into the waste bin.
- Do not pre-rinse dishes by hand. When needed, use the prewash programme (if available) or select a programme with a prewash phase.
- When loading the appliance, make sure that the dishes can be completely reached and

washed by the water released from the spray arm nozzles. Make sure that items do not touch or cover each other.

- You can use dishwasher detergent, rinse aid and salt separately or you can use the multi-tablets (e.g. "3 in 1", "4 in 1", "All in 1"). Follow the instructions written on the packaging.
- Select the programme according to the type of load and degree of soil. With the ECO programme you have the most efficient use of water and energy consumption for crockery and cutlery with normal soil.

Using salt, rinse aid and detergent

- Only use salt, rinse aid and detergent for dishwasher. Other products can cause damage to the appliance.
- In areas with hard and very hard water we recommend to use plain dishwasher detergent (powder, gel, tablets containing no additional agents), rinse aid and salt separately for optimal cleaning and drying results.
- At least once a month run the appliance with the use of appliance cleaner which is particularly suitable for this purpose.
- Detergent tablets do not fully dissolve with short programmes. To prevent detergent residues on the tableware, we recommend that you use the tablets with long programmes.
- Do not use more than the correct quantity of detergent. Refer to the instructions on the detergent packaging.

What to do if you want to stop using multi-tablets

Before you start to use separately detergent, salt and rinse aid do the following procedure.

1. Set the highest level of the water softener.
2. Make sure that the salt and rinse aid containers are full.
3. Start the shortest programme with a rinsing phase. Do not add detergent and do not load the baskets.
4. When the programme is completed, adjust the water softener according to the water hardness in your area.
5. Adjust the released quantity of rinse aid.
6. Activate the rinse aid empty notification.

Loading the baskets

-  Refer to the supplied leaflet with examples of the load of the baskets.
- Only use the appliance to wash items that are dishwasher-safe.
- Do not put in the appliance items made of

wood, horn, aluminium, pewter and copper.



- Do not put in the appliance items that can absorb water (sponges, household cloths).
- Remove remaining food from the items.
- Soak items with remaining burned food in water.
- Put hollow items (cups, glasses and pans) with the opening down.
- Make sure that cutlery and dishes do not bond together. Mix spoons with other cutlery.
- Make sure that glasses do not touch each other.
- Put small items in the cutlery basket.
- Put light items in the upper basket. Make sure that the items do not move.
- Make sure that the spray arm can move freely before you start a programme.

Before starting a programme

Make sure that:

- The filters are clean and correctly installed.
- The cap of the salt container is tight.
- The spray arms are not clogged.
- There is dishwasher salt and rinse aid (unless you use multi-tablets).
- The position of the items in the baskets is correct.
- The programme is applicable for the type of load and for the degree of soil.
- The correct quantity of detergent is used.

Unloading the baskets

-  For better drying results keep the appliance door ajar for some minutes before you remove the dishes.
- 1. Let the dishes cool down before you remove them from the appliance. Hot dishes are easily damaged.
- 2. First remove items from the lower basket then the upper basket.
-  At the end of the program water can still remain on the sides and on the door of the appliance.

Care and cleaning

-  **Warning!** Before maintenance, deactivate the appliance and disconnect the mains plug from the main socket.

-  Dirty filters and clogged spray arms

decrease the washing results. Make a check regularly and, if necessary, clean them.

Cleaning the filters

1. Turn the filter counterclockwise to unlock, then lift it out of the appliance.

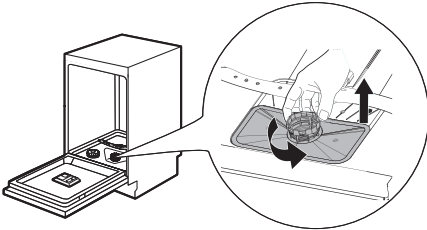

2. First pull the filter (A) out of the filter assembly by compressing it gently. Then the filters (B) and (C) can be detached.

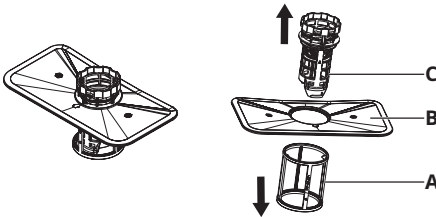

3. Rinse the filters (A), (B) and (C) with water. If necessary, use a soft cleaning brush.
4. Re-assemble the filters shown in the figure below.

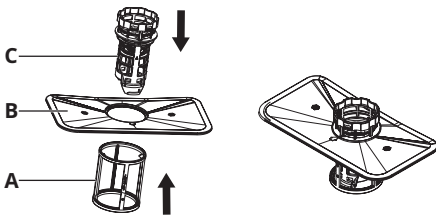

5. Insert the filter assembly into position, and turn it clockwise until it locks. Make sure the arrows on the filter (B) and (C) are aligned, as shown in the figure below.

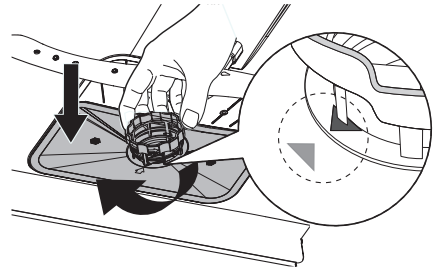

Cleaning the spray arms

We recommend to clean regularly the upper and lower spray arms to avoid soil to clog the holes.

Clogged holes can cause unsatisfactory washing results.

1. Pull out the upper and lower baskets.
2. To disengage the upper spray arm from the upper basket, locate the nut in the center position of the upper arm and turn it counterclockwise to remove.

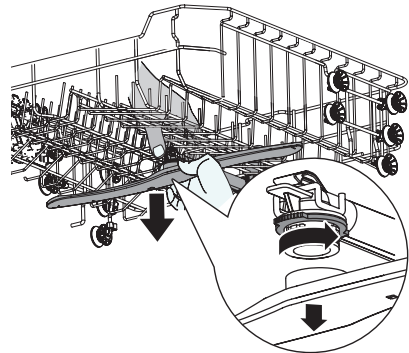

3. To detach the lower spray arm from the bottom of the appliance, just pull it up to remove.

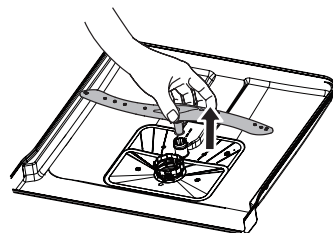

4. Rinse the upper and lower spray arms under running water.
Use a thin pointed tool (e.g. a toothpick) to remove particles of soil from the holes of the arm sprays.
5. After cleaning, replace the arm sprays.
To attach the upper spray arm to the upper basket, align the center position of the upper spray arm with the nut then turn it clockwise to tighten.

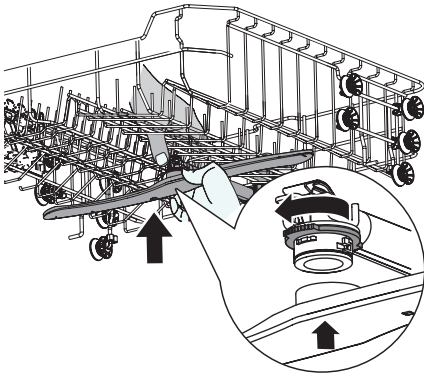
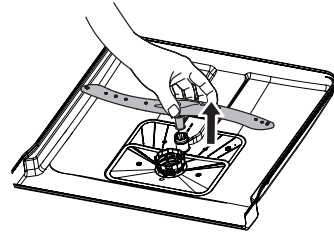

To attach the lower arm spray to the bottom of the appliance, insert the lower arm spray into position.

External cleaning

- Clean the appliance with a moist soft cloth.
- Only use neutral detergents.
- Do not use abrasive products, abrasive cleaning pads or solvents.

Internal cleaning

- Carefully clean the appliance, including the rubber gasket of the door, with a soft damp cloth.
- To maintain the performance of your appliance, use a cleaning product designed specifically for dishwashers at least once a month. Carefully follow the instructions on the packaging of the product.
- Do not use abrasive products, abrasive cleaning pads, sharp tools, strong chemicals, scourer or solvents.
- Using short-duration programmes regularly can cause grease and limescale buildup inside the appliance.
Run long-duration programmes at least twice a month to prevent the buildup.

Troubleshooting

If the appliance does not start or it stops during operation, first check if you can solve the problem by yourself with the help of the information in the table or contact an Authorised Service Centre.

⚠ Warning! Repairs not properly done may result in serious risk to the safety of the user. Any repairs must be performed by qualified personnel.

With some problems, the display shows an alarm code.
The majority of problems that can occur can be solved without the need to contact an Authorised Service Centre.

| Problem and alarm code | Possible cause and solution |
|------------------------------------|---|
| You cannot activate the appliance. | <ul style="list-style-type: none"> • Make sure that the mains plug is connected to the mains socket. • Make sure that there is no damaged fuse in the fuse box. |

| Problem and alarm code | Possible cause and solution |
|--|---|
| The program does not start. | <ul style="list-style-type: none"> • Make sure that the appliance door is closed. • If the delay start is set, cancel the setting or wait for the end of the countdown. • The appliance has started the procedure to recharge the resin inside the water softener. The duration of the procedure is approximately 5 minutes. |
| The appliance does not fill with water. The display shows "E1". | <ul style="list-style-type: none"> • Make sure that the water tap is open. • Make sure that the pressure of the water supply is not too low. For this information, contact your local water authority. • Make sure that the water tap is not clogged. • Make sure that the filter in the inlet hose is not clogged. • Make sure that the inlet hose has no kinks or bends. |
| The appliance does not reach the required temperature. The display shows "E3". | <ul style="list-style-type: none"> • Heating element malfunctions. Contact an Authorised Service Centre. |
| The anti-flood device is on. The display shows "E4". | <ul style="list-style-type: none"> • Close the water tap and contact an Authorised Service Centre. |
| The appliance does not drain the water. | <ul style="list-style-type: none"> • Make sure that the sink spigot is not clogged. • Make sure that the filter in the outlet hose is not clogged. • Make sure that the interior filter system is not clogged. • Make sure that the drain hose has no kinks or bends. |
| The appliance stops and starts more times during operation. | <ul style="list-style-type: none"> • It is normal. It provides optimal cleaning results and energy savings. |
| The program lasts too long. | <ul style="list-style-type: none"> • If the delayed start option is set, cancel the delay setting or wait for the end of the countdown. |
| The remaining time in the display increases and skips nearly to the end of program time. | <ul style="list-style-type: none"> • This is not a defect. The appliance is working correctly. |
| Small leak from the appliance door. | <ul style="list-style-type: none"> • The appliance is not levelled. Loosen or tighten the adjustable feet (if applicable). • The appliance door is not centred on the tub. Adjust the rear foot (if applicable). |
| The appliance door is difficult to close. | <ul style="list-style-type: none"> • The appliance is not levelled. Loosen or tighten the adjustable feet (if applicable). • Parts of the tableware are protruding from the baskets. |
| Rattling/knocking sounds from inside the appliance. | <ul style="list-style-type: none"> • The tableware is not properly arranged in the baskets. Refer to basket loading leaflet. • Make sure that the spray arms can rotate freely. |

| Problem and alarm code | Possible cause and solution |
|--|---|
| The appliance trips the circuit-breaker. | <ul style="list-style-type: none"> • The amperage is insufficient to supply simultaneously all the appliances in use. Check the socket amperage and the capacity of the meter or turn off one of the appliances in use. • Internal electrical fault of the appliance. Contact an Authorised Service Centre. |

i Refer to "**Before first use**", "**Daily use**", or "**Hints and tips**" for other possible causes. For alarm codes not described in the table, contact an Authorised Service Centre.

Once you have checked the appliance, deactivate and activate the appliance. If the problem occurs again, contact an Authorised Service Centre.

The washing and drying results are not satisfactory

| Problem | Possible cause and solution |
|---|--|
| Poor washing results. | <ul style="list-style-type: none"> • Refer to "Daily use", "Hints and tips" and basket loading leaflet. • Use more intensive washing programmes. • Clean spray arm jets and filter. Refer to "Care and Cleaning". |
| Poor drying results. | <ul style="list-style-type: none"> • Tableware has been left for too long inside a closed appliance. • There is no rinse aid or the dosage of rinse aid is not enough. Set the rinse aid dispenser to a higher level. • Plastic items may need to be towel dried. • For the best drying performance activate the dry plus option. • We recommend to always use rinse aid, even in combination with multi-tablets. |
| There are whitish streaks or bluish layers on glasses and dishes. | <ul style="list-style-type: none"> • The release quantity of rinse aid is too much. Adjust the rinse aid level to a lower level. • The quantity of detergent is too much. |
| There are stains and dry water drops on glasses and dishes. | <ul style="list-style-type: none"> • The released quantity of rinse aid is not sufficient. Adjust the rinse aid level to a higher level. • The quality of the rinse aid can be the cause. |
| The dishes are wet. | <ul style="list-style-type: none"> • For the best drying performance activate the dry plus option. • The programme does not have a drying phase or has a drying phase with low temperature. • The rinse aid dispenser is empty. • The quality of the rinse aid can be the cause. • The quality of the multi-tablets can be the cause. Try a different brand or activate the rinse aid dispenser and use rinse aid and multi-tablets together. |
| The interior of the appliance is wet. | <ul style="list-style-type: none"> • This is not a defect of the appliance. It is caused by the humidity in the air that condenses on the walls. |

| | |
|--|--|
| Unusual foam during washing. | <ul style="list-style-type: none"> • Use the detergent for dishwashers only. • There is a leak in the rinse aid dispenser. Contact an Authorised Service Centre. |
| Traces of rust on cutlery. | <ul style="list-style-type: none"> • There is too much salt in the water used for washing. Refer to "The water softener". • Silver and stainless steel cutlery were placed together. Avoid to put silver and stainless steel items close together. |
| There are residues of detergent in the dispenser at the end of the programme. | <ul style="list-style-type: none"> • The detergent tablet got stuck in the dispenser and therefore was not completely washed away by water. • Water cannot wash away the detergent from the dispenser. Make sure that the spray arm is not blocked or clogged. • Make sure that items in the baskets do not impede the lid of the detergent dispenser from opening. |
| Odours inside the appliance. | <ul style="list-style-type: none"> • Refer to "Internal cleaning". |
| Limescale deposits on the tableware, on the tub and on the inside of the door. | <ul style="list-style-type: none"> • The level of salt is low, check the refill indicator. • The cap of the salt container is loose. • Your tap water is hard. Refer to "The water softener". • Even using multi-functional tabs use salt and set regeneration of the water softener. Refer to "The water softener". • If limescale deposits still remain, clean the appliance with appliance cleaners which are particularly suitable for this purpose. • Try different detergent. • Contact the detergent manufacturer. |
| Dull, discoloured or chipped tableware. | <ul style="list-style-type: none"> • Make sure that only dishwasher-safe items are washed in the appliance. • Load and unload the basket carefully. Refer to basket loading leaflet. • Place delicate items in the upper basket. |

i Refer to "**Before first use**", "**Daily use**" or "**Hints and tips**" for other possible causes.

Technical information

| | |
|-------------------------|---|
| Product name | LAGAN 30509006 |
| Product type | Dishwasher |
| Installation type | Built-in |
| Dimensions (W x H x D) | 448 x 815 x 550 mm (door closed) 448 x 815 x 1150 mm (door open 90°) |
| Standard place settings | 10 |

Technical information

| | |
|--|---|
| Product name | LAGAN 30509006 |
| Product type | Dishwasher |
| Installation type | Built-in |
| Dimensions (W x H x D) | 448 x 815 x 550 mm (door closed) 448 x 815 x 1150 mm (door open 90°) |
| Noise level | 47 dB(A) |
| Power consumption | 1760W |
| Rated voltage / frequency ⁵⁾ | 220 V / 50 Hz |
| Water pressure (flow pressure) | Min. 0,04 MPa (0,4 bar) / Max. 1,0 MPa (10 bar) |
| Water supply (cold water or hot water) ⁶⁾ | max. 70 °C |

Environmental concerns

Recycle materials with the symbol . Put the packaging in relevant containers to recycle it. Help protect the environment and human health by recycling waste of electrical and electronic

appliances. Do not dispose of appliances marked with the symbol  with the household waste. Return the product to your local recycling facility or contact your municipal office.

IKEA GUARANTEE

How long is the IKEA guarantee valid?

This guarantee is valid for five (5) years from the original date of purchase of your appliance at IKEA. The original sales receipt is required as proof of purchase. If service work is carried out under guarantee, this will not extend the guarantee period for the appliance.

Which LAGAN appliances are not covered by the IKEA 5-year guarantee?

LAGAN appliances purchased from IKEA before 1 May 2026 are covered by a 2-year guarantee, starting from the original date of purchase.

Who will execute the service?

IKEA service provider will provide the service through its own service operations or authorized service partner network.

What does this guarantee cover?

The guarantee covers faults of the appliance, which have been caused by faulty construction or material faults from the date of purchase from IKEA. This guarantee applies to domestic use only. The exceptions are specified under the headline "What is not covered under this guarantee?" Within the guarantee period, the costs to remedy the fault e.g. repairs, parts, labour and travel will be covered, provided that the appliance is accessible for repair without special expenditure. On these conditions the

respective local regulations are applicable. Replaced parts become the property of IKEA.

What will IKEA do to correct the problem?

IKEA appointed Service Provider will examine the product and decide, at its sole discretion, if it is covered under this guarantee. If considered covered, IKEA Service Provider or its authorized service partner through its own service operations, will then, at its sole discretion, either repair the defective product or replace it with the same or a comparable product.

What is not covered under this guarantee?

- Normal wear and tear.
- Deliberate or negligent damage, damage caused by failure to observe operating instructions, incorrect installation or by connection to the wrong voltage, damage caused by chemical or electro-chemical reaction, rust, corrosion or water damage including but not limited to damage caused by excessive lime in the water supply, damage caused by abnormal environmental conditions.

- Consumable parts including batteries and lamps.
- Non-functional and decorative parts which do not affect normal use of the appliance, including any scratches and possible color differences.
- Accidental damage caused by foreign objects or substances and cleaning or unblocking of filters, drainage systems or soap drawers.
- Damage to the following parts: ceramic glass, accessories, crockery and cutlery baskets, feed and drainage pipes, seals, lamps and lamp covers, screens, knobs, casings and parts of casings. Unless such damages can be proved to have been caused by production faults.
- Cases where no fault could be found during a technician's visit.
- Repairs not carried out by our appointed service providers and/or an authorized service contractual partner or where non-original parts have been used.
- Repairs caused by installation which is faulty or not according to specification.
- The use of the appliance in a non-domestic environment i.e. professional use.
- Transportation damages. If a customer transports the product to his home or another address, IKEA is not liable for any damage that may occur during transport. However, if IKEA delivers the product to the customer's delivery address, then damage to the product that occurs during this delivery will be covered by IKEA.
- Cost for carrying out the initial installation of the IKEA appliance.
- However, if an IKEA appointed Service Provider or its authorized service partner repairs or replaces the appliance under the terms of this guarantee, the appointed Service Provider or its authorized service partner will reinstall the repaired appliance or install the replacement, if necessary.
- All plumbing and electrical installation, are not the responsibility of IKEA, and customer must complete these work before the execution work.

How country law applies

The IKEA guarantee gives you specific legal rights, which cover or exceed all the local legal demands. However these conditions do not limit in any way consumer rights described in the local legislation.

Area of validity

This warranty is valid only in the country where the product has been purchased; the services will be provided in the framework of the guarantee conditions. An obligation to carry out services in the framework of the guarantee exists only if the appliance complies and is installed in accordance with:

- the technical specifications of the country in which the guarantee claim is made;
- the Assembly Instructions and User Manual Safety Information;

The dedicated AFTER SALES for IKEA appliances



Please don't hesitate to contact IKEA appointed Authorized Service Centre to:

- make a service request under this guarantee;
- ask for clarifications on installation of the IKEA appliance in the dedicated IKEA kitchen furniture;
- ask for clarification on functions of IKEA appliances.

To ensure that we provide you with the best assistance, please read carefully the Assembly Instructions and/or the User Manual before contacting us.

How to reach us if you need our service



-  The IKEA after sales customer service centre will assist you on the phone with basic troubleshooting for your appliances at the time of service call request. Please refer to **www.IKEA.com** and select your local store for local store phone numbers and opening times.
-  Before calling us, assure that You have to hand the IKEA article number (8 digit code) and the Serial Number (8 digit code that can be found on the rating plate) for the appliance of which you need our assistance.
-  **SAVE THE SALES RECEIPT!** It is your proof of purchase and required for the guarantee to apply. Note that the receipt reports also the IKEA article name and number (8 digit code) for each of the appliances you have purchased.

Do you need extra help?

For any additional questions not related to After Sales of your appliances please contact your nearest IKEA store call centre. We recommend you read the appliance documentation carefully before contacting us.

