

TILLREDA



Design and Quality
IKEA of Sweden

ENGLISH

1. SAFETY INFORMATION	5
2. PRODUCT DESCRIPTION	10
3. CONTROL PANEL	11
4. TROUBLE SHOOTING	12
5. SPECIFICATIONS	12
6. INSTALLATION AND CONNECTION	13
7. ENVIRONMENTAL CONCERNS	13
8. IKEA GUARANTEE	14

ENGLISH

Read these instructions carefully before using your microwave oven, and keep it carefully.

If you follow the instructions, your oven will provide you with many years of good service.

**SAVE THESE
INSTRUCTIONS
CAREFULLY**

1. SAFETY INFORMATION



PRECAUTIONS TO AVOID POSSIBLE EXPOSURE TO EXCESSIVE MICROWAVE ENERGY

- a) Do not attempt to operate this oven with the door open since this can result in harmful exposure to microwave energy. It is important not to break or tamper with the safety interlocks.
- b) Do not place any object between the oven front face and the door or allow soil or cleaner residue to accumulate on sealing surfaces.
- c) **WARNING:** If the door or door seals are damaged, the oven must not be operated until it has been repaired by a competent person.

ADDENDUM

If the apparatus is not maintained in a good state of cleanliness, its surface could be degraded and affect the lifespan of the apparatus and lead to a dangerous situation.

IMPORTANT SAFETY INSTRUCTIONS WARNING

To reduce the risk of fire, electric shock, injury to persons or exposure to excessive microwave oven energy when using your appliance, follow basic precautions, including the following:

1. Read and follow the specific: **"PRECAUTIONS TO AVOID POSSIBLE EXPOSURE TO EXCESSIVE MICROWAVE ENERGY"**.
2. This device can be used by children of at least 8 years old and by people with reduced physical, sensory or mental capacities or lacking experience or knowledge, if they are properly supervised or if they were given instructions relating to the safe use of the device and if the risks involved have been understood. Children must not play with the device. Cleaning and maintenance by the user must not be carried out by unsupervised children.
3. Keep the appliance and its cord out of reach of children less than 8 years.

ENGLISH

4. If the supply cord is damaged, it must be replaced by the manufacturer, its service agent or similarly qualified persons in order to avoid a hazard.
5. **WARNING:** It is hazardous for anyone other than a competent person to carry out any service or repair operation that involves the removal of a cover which gives protection against exposure to microwave energy.
6. Heating beverages by microwaves can cause a sudden, delayed burst of boiling liquid.
7. When heating food in plastic or paper containers, keep an eye on the oven due to the possibility of ignition.
8. Only use utensils that are suitable for use in microwave ovens.
9. If smoke is emitted, switch off or unplug the appliance and keep the door closed in order to stifle any flames.
10. Microwave heating of beverages can result in delayed eruptive boiling, therefore care must be taken when handling the container.
11. The contents of feeding bottles and baby food jars shall be stirred or shaken and the temperature checked before consumption, in order to avoid burns.
12. Eggs in their shell and whole hard-boiled eggs should not be heated in microwave ovens since they may explode, even after microwave heating has ended.
13. The oven should be cleaned regularly and any food deposits removed.
14. Failure to maintain the oven in a clean condition could lead to deterioration of the surface that could adversely affect the life of the appliance and possibly result in a hazardous situation.
15. The appliance must not be installed behind a decorative door in order to avoid overheating.
16. The microwave oven must be operated with any cabinet door open.
17. This appliance is intended to be used in household and similar applications such as:

ENGLISH

- staff kitchen areas in shops, offices and other working environments;
 - by clients in hotels, motels and other residential type environments;
 - farm houses;
 - bed and breakfast type environments.
18. The microwave oven is intended for heating food and beverages. Drying of food or clothing and heating of warming pads, slippers, sponges, damp cloth and similar may lead to risk of injury, ignition or fire.
19. Metallic containers for food and beverages are not allowed during microwave cooking.
20. The appliance shall not be cleaned with a steam cleaner.
21. The appliance is intended to be used freestanding or in a cabinet.
22. The rear surface of appliances shall be placed against a wall.
23. This appliance is for household and indoor use only. Don't use it outdoors!
24. To protect against electric shock, do not immerse main parts of the product, cord or plug in water or other liquids.
25. **WARNING:** Liquids and other foods must not be heated in sealed containers since they are liable to explode.

READ CAREFULLY AND KEEP FOR FUTURE REFERENCE.

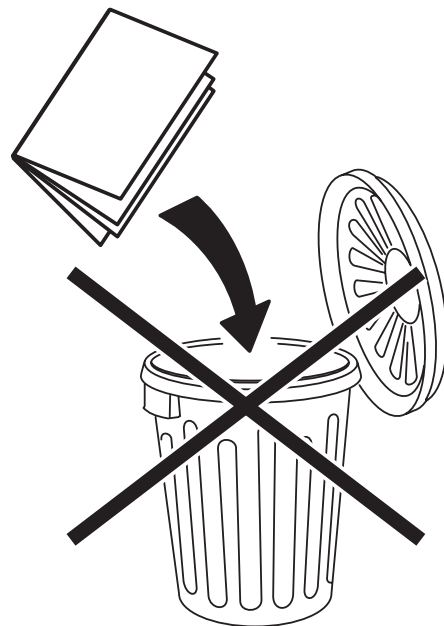

ENGLISH

TO REDUCE THE RISK OF INJURY TO PERSONS GROUNDING INSTALLATION

DANGER

Electric Shock Hazard

Touching some of the internal components can cause serious personal injury or death. Do not disassemble this appliance.

WARNING

Electric Shock Hazard

Improper use of the grounding can result in electric shock. Do not plug into an outlet until appliance is properly installed and grounded.

This appliance must be grounded. In the event of an electrical short circuit, grounding reduces the risk of electric shock by providing an escape wire for the electric current. This appliance is equipped with a cord having a grounding wire with a grounding plug. The plug must be plugged into an outlet that is properly installed and grounded.

Consult a qualified electrician or serviceman if the grounding instructions are not completely understood or if doubt exists as to whether the appliance is properly grounded. If it is necessary to use an extension cord, use only a 3-wire extension cord.

1. A short power-supply cord is provided to reduce the risks resulting from becoming entangled in or tripping over a longer cord.
2. If a long cord set or extension cord is used:
 - a) The marked electrical rating of the cord set or extension cord should be at least as great as the electrical rating of the appliance.
 - b) The extension cord must be a grounding-type 3-wire cord.
 - c) The long cord should be arranged so that it will not drape over the counter top or tabletop where it can be pulled on by children or tripped over unintentionally.

CLEANING

Be sure to unplug the appliance from the power supply.

1. Clean the cavity of the oven after using with a slightly damp cloth.
2. Clean the accessories in the usual way in soapy water.
3. The door frame and seal and

neighbouring parts must be cleaned carefully with a damp cloth when they are dirty.

4. Do not use harsh abrasive cleaners or sharp metal scrapers to clean the oven door glass since they can scratch the surface, which may result in shattering of the glass.
5. *Cleaning Tip* ★ For easier cleaning of the cavity walls that the food cooked can touch: Place half a lemon in a bowl, add 300ml (1/2 pint) water and heat on 100% microwave power for 10 minutes. Wipe the oven clean using a soft, dry cloth.

UTENSILS

CAUTION

Personal Injury Hazard

It is hazardous for anyone other than a competent person to carry out any service or repair operation that involves the removal of a cover which gives protection against exposure to microwave energy.

See the instructions on **“MATERIALS YOU CAN USE IN MICROWAVE OVEN OR TO BE AVOIDED IN MICROWAVE OVEN.”**

There may be certain non-metallic utensils that are not safe to use for microwaving. If in doubt, you can test the utensil in question following the procedure below.

Utensil Test:

1. Fill a microwave-safe container with 1 cup of cold water (250ml) along with the utensil in question.
2. Cook on maximum power for 1 minute.
3. Carefully feel the utensil. If the empty utensil is warm, do not use it for microwave cooking.
4. Do not exceed 1 minute cooking time.

ENGLISH

MATERIALS YOU CAN USE IN MICROWAVE OVEN

Utensils	Remarks
Browning dish	Follow manufacturer's instructions. The bottom of browning dish must be at least 3/16 inch (5mm) above the turntable. Incorrect usage may cause the turntable to break.
Dinnerware	Microwave-safe only. Follow manufacturer's instructions. Do not use cracked or chipped dishes.
Glass jars	Always remove lid. Use only to heat food until just warm. Most glass jars are not heat resistant and may break.
Glassware	Heat-resistant oven glassware only. Make sure there is no metallic trim. Do not use cracked or chipped dishes.
Oven cooking bags	Follow manufacturer's instructions. Do not close with metal tie. Make slits to allow steam to escape.
Paper plates and cups	Use for short-term cooking/warming only. Do not leave oven unattended while cooking.
Paper towels	Use to cover food for reheating and absorbing fat. Use with supervision for a short-term cooking only.
Parchment paper	Use as a cover to prevent splattering or a wrap for steaming.
Plastic	Microwave-safe only. Follow the manufacturer's instructions. Should be labeled "Microwave Safe". Some plastic containers soften, as the food inside gets hot. "Boiling bags" and tightly closed plastic bags should be slit, pierced or vented as directed by package.
Plastic wrap	Microwave-safe only. Use to cover food during cooking to retain moisture. Do not allow plastic wrap to touch food.
Thermometers	Microwave-safe only (meat and candy thermometers).
Wax paper	Use as a cover to prevent splattering and retain moisture.

MATERIALS TO BE AVOIDED IN MICROWAVE OVEN

Utensils	Remarks
Aluminum tray	May cause arcing. Transfer food into microwave-safe dish.
Food carton with metal handle	May cause arcing. Transfer food into microwave-safe dish.
Metal or metal-trimmed utensils	Metal shields the food from microwave energy. Metal trim may cause arcing.
Metal twist ties	May cause arcing and could cause a fire in the oven.
Paper bags	May cause a fire in the oven.
Plastic foam	Plastic foam may melt or contaminate the liquid inside when exposed to high temperature.
Wood	Wood will dry out when used in the microwave oven and may split or crack.

ENGLISH

2. PRODUCT DESCRIPTION

SETTING UP YOUR OVEN

Name of Oven Parts and Accessories

Remove the oven and all materials from the carton and oven cavity. Your oven comes with the following accessories:

Glass tray	1x
Turntable ring assembly	1x
Instruction Manual	1x

- A. Control panel
- B. Turntable shaft
- C. Turntable ring assembly
- D. Glass tray
- E. Observation window
- F. Door assembly
- G. Safety interlock system

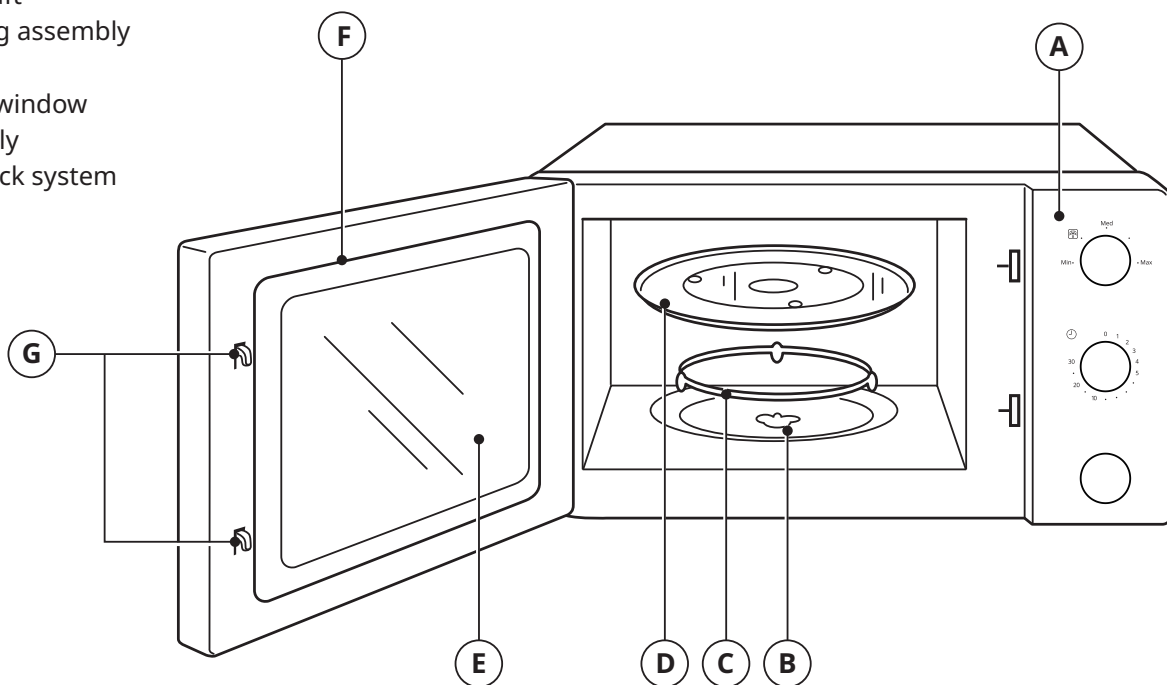

Turntable Installation

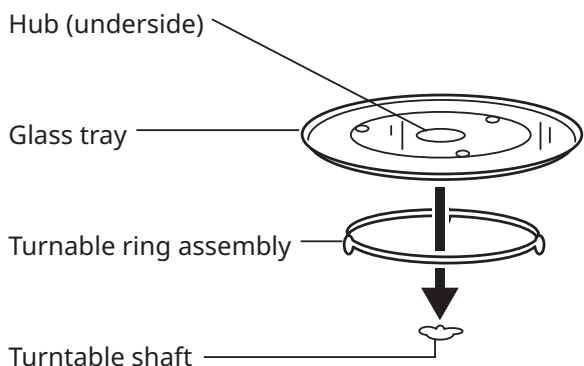

- a) Never place the glass tray upside down. The glass tray should never be restricted.
- b) Both glass tray and turntable ring assembly must always be used during cooking.
- c) All food and containers of food are always placed on the glass tray for cooking.
- d) If glass tray or turntable ring assembly cracks or breaks, contact your nearest authorized service center.

3. CONTROL PANEL

Control Panel and Features Operation Instructions

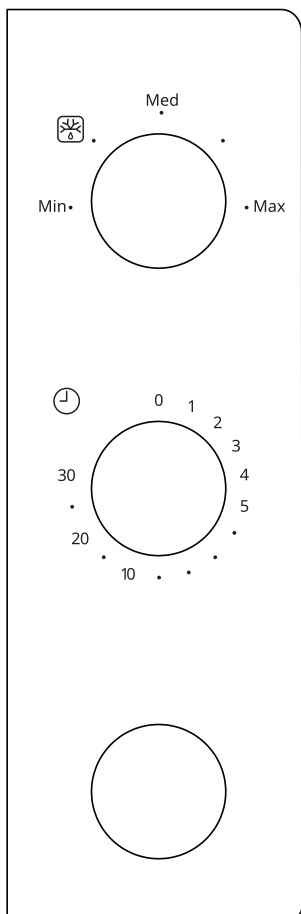

1. To set cooking power by turning the power knob to desired level.
2. To set the time of cooking by turning the timer knob to desired time per your food cooking guide.
3. The microwave oven will automatically start cooking after power level and time are set.
4. After the cooking time is up, the unit will “Dong” to stop.
5. If the unit is not in use, always set time to “0”.

Function/Power	Watts	Application
Min	115 W	Soften ice cream
	230 W	Soup stew, soften butter or defrost
Med	390 W	Stew, fish
.	540 W	Rice, fish, chicken, ground meat
Max	700 W	Reheat, milk, boil water, vegetables, beverage

Notice:

When removing food from the oven, please ensure that the oven power is switched off by turning the timer switch to 0 (zero).

Failure to do so, and operating the microwave oven without food in it, can result in overheating and damage to the magnetron.

ENGLISH

4. TROUBLE SHOOTING

Normal	
Microwave oven interfering TV reception	Radio and TV reception may be interfered when microwave oven operating. It is similar to the interference of small electrical appliances, like mixer, vacuum cleaner, electric fan. It is normal.
Dim oven light	In low power microwave cooking, oven light may become dim. It is normal.
Steam accumulating on door, hot air out of vents.	In cooking, steam may come out of food. Most will get out from vents, but some may accumulate on cool place like oven door. It is normal.
Oven started accidentally with no food in.	<i>It is forbidden to run the unit without any food inside. It is very dangerous.</i>

Trouble	Possible cause	Remedy
Oven can not be started.	(1) Power cord not plugged tightly.	Unplug. Then unplug again after 10 seconds.
	(2) Fuse blowing or circuit breaker works.	Replace fuse or reset circuit breaker (repaired by professional personnel of our company)
	(3) Trouble with outlet.	Test outlet with other electrical appliances.
Oven does not heat	(4) Door not closed well.	Close door well.

5. SPECIFICATIONS

Model:	TILLREDA 804.933.62
Rated Voltage:	230-240V~ 50Hz
Rated Input Power(Microwave):	1050W
Rated Output Power(Microwave):	700 W
Oven Capacity:	20 L
Turntable Diameter:	255 mm
External Dimensions:	439.5x340.0x258.2mm
Net Weight:	10.75 kg

6. INSTALLATION AND CONNECTION

Countertop Installation

Remove all packing material and accessories. Examine the oven for any damage such as dents or broken door. Do not install if oven is damaged.

Cabinet: Remove any protective film found on the microwave oven cabinet surface.

Do not remove the light brown Mica cover that is attached to the oven cavity to protect the magnetron.

Installation

1. Select a level surface that provide enough open space for the intake and/or outlet vents.

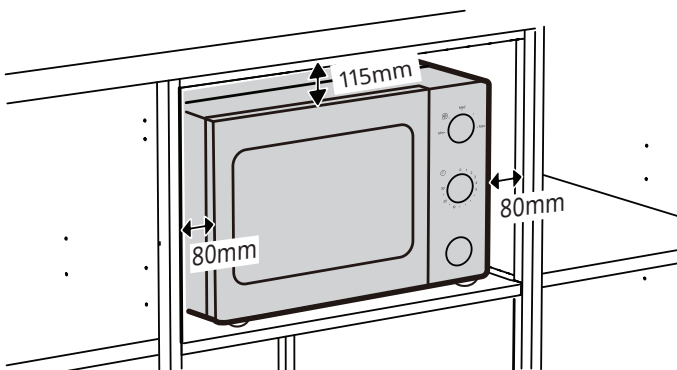

- (1) The rear surface of appliance shall be placed against a wall. Leave a minimum clearance of 11.5 cm above the oven, a minimum clearance of 8 cm is required between the oven and any adjacent walls.
- (2) Do not remove the legs from the bottom of the oven.

- (3) Blocking the intake and/or outlet openings can damage the oven.
- (4) Place the oven as far away from radios and TV as possible. Operation of microwave oven may cause interference to your radio or TV reception.

2. Plug your oven into a standard household outlet. Be sure the voltage and the frequency is the same as the voltage and the frequency on the rating label.

WARNING: Do not install oven over a range cooktop or other heat-producing appliance. If installed near or over a heat source, the oven could be damaged and the warranty would be void.



The accessible surface may be hot during operation.

7. ENVIRONMENTAL CONCERNS



According to Waste of Electrical and Electronic Equipment (WEEE) directive, WEEE should be separately collected and treated. If at any time in future you need to dispose of this product please do NOT dispose of this product with household waste. Please send this product to WEEE collecting points where available.

8. IKEA GUARANTEE

How long is the IKEA guarantee valid?

This guarantee is valid for two (2) years from the original date of purchase of your appliance at IKEA. The original sales receipt, is required as proof of purchase. If service work is carried out under guarantee, this will not extend the guarantee period for the appliance.

Who will execute the service?

Contact nearest IKEA store.

What does this guarantee cover?

The guarantee covers faults of the appliance, which have been caused by faulty construction or material faults from the date of purchase from IKEA. This guarantee applies to domestic use only. The exceptions are specified under the headline "What is not covered under this guarantee?" Within the guarantee period, the costs to remedy the fault e.g. repairs, parts, labour and travel will be covered, provided that the appliance is accessible for repair without special expenditure. Replaced parts become the property of IKEA.

What will IKEA do to correct the problem?

IKEA will examine the product and decide, at its sole discretion, if it is covered under this guarantee. If considered covered, IKEA will then, at its sole discretion, either repair the defective product or replace it with the same or a comparable product.

What is not covered under this guarantee?

- Normal wear and tear.
- Deliberate or negligent damage, damage caused by failure to observe operating instructions, incorrect installation or by connection to the wrong voltage, damage caused by chemical or electrochemical reaction, rust, corrosion or water damage including but not limited to damage caused by excessive lime in the water supply, damage caused by abnormal environmental conditions.
- Consumable parts including batteries and lamps.
- Non-functional and decorative parts which do not affect normal use of the appliance, including any scratches and possible colour differences.
- Accidental damage caused by foreign objects or substances and cleaning or unblocking of filters, drainage systems or soap drawers.
- Damage to the following parts: ceramic glass, accessories, crockery and cutlery baskets, feed and drainage pipes, seals, lamps and lamp covers,

screens, knobs, casings and parts of casings. Unless such damages can be proved to have been caused by production faults.

- Repairs not carried out by our appointed service providers and/or an authorized service contractual partner or where non-original parts have been used.
- Repairs caused by installation which is faulty or not according to specification.
- The use of the appliance in a non-domestic environment i.e. professional use.
- Transportation damages. If a customer transports the product to his home or another address, IKEA is not liable for any damage that may occur during transport. However, if IKEA delivers the product to the customer's delivery address, then damage to the product that occurs during this delivery will be covered by IKEA.
- Cost for carrying out the initial installation of the IKEA appliance. However, if an IKEA appointed Service Provider or its authorized service partner repairs or replaces the appliance under the terms of this guarantee, the appointed Service Provider or its authorized service partner will reinstall the repaired appliance or install the replacement, if necessary.

How country law applies

The IKEA guarantee gives you specific legal rights, which cover or exceed all the local legal demands. However these conditions do not limit in any way consumer rights described in the local legislation.

Area of validity

For appliances which are purchased in one EU country and taken to another EU country, the services will be provided in the framework of the guarantee conditions normal in the new country. An obligation to carry out services in the framework of the guarantee exists only if the appliance complies and is installed in accordance with:

- the technical specifications of the country in which the guarantee claim is made;
- the Assembly Instructions and User Manual Safety Information.

AFTER SALES for IKEA appliances

Please don't hesitate to contact IKEA to:

- make a service request under this guarantee.
- ask for clarification on functions of IKEA appliances.

To ensure that we provide you with the best assistance, please read carefully the Assembly Instructions and/or the User Manual before contacting us.

ENGLISH

How to reach us if you need our service



The IKEA after sales customer service centre will assist you on the phone with basic trouble shooting for your appliance at the time of service call request. Please see the IKEA catalogue or visit www.ikea.com to find your local store phone number and opening time.

In order to provide you a quicker service, please also always refer to the IKEA article number (8 digit code) placed on the rating plate of your appliance.

SAVE THE SALES RECEIPT!

It is your proof of purchase and required for the guarantee to apply. The sales receipt also reports the IKEA name and article number (8 digit code) for each of the appliances you have purchased.

Do you need extra help?

For any additional questions not related to After Sales of your appliances please contact your nearest IKEA store call centre. We recommend you read the appliance documentation carefully before contacting us.

