

Buying guide

PAX & KOMPLEMENT

Wardrobe system

Safety

This furniture must be fixed to the wall. Different wall materials require different types of fixing devices. Use fixing devices suitable for the walls in your home, sold separately.

Assembly

Minimum ceiling heights required:

Hinged doors:

For 201 cm height frames:
220 cm.

For 236 cm height frames:
250 cm

IMPORTANT: 2 persons are required to assemble this furniture safely.

10

The PAX Wardrobe system has a 10-year guarantee. Read more in the guarantee brochure.

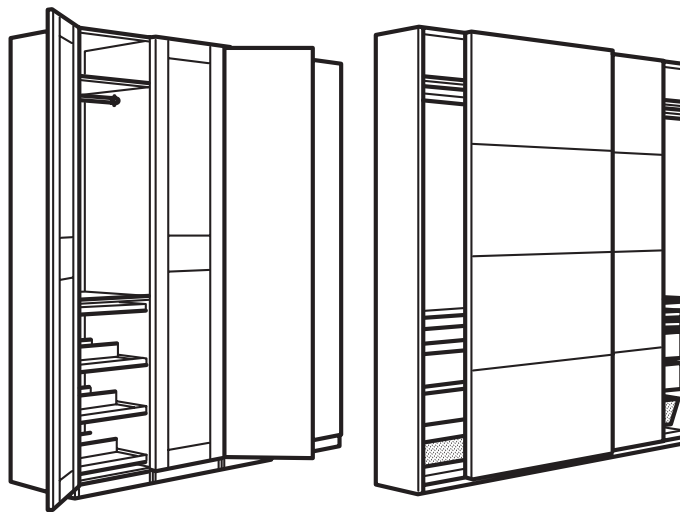

Create your own wardrobe

By combining frames and doors from the PAX series with items from the KOMPLEMENT series of interior organisers, you can create exactly the wardrobe you need. Or you can choose one of our suggested storage solutions and add or remove interior organisers as you wish. Whatever you choose, the result is a wardrobe to suit both your home and your clothes.

Use our planning tools

You can create your wardrobe in the planner found in the PAX area of the store or in the comfort of your own home. Just visit the bedroom section of the IKEA website, go to the PAX planner and start making a wardrobe uniquely designed for you – by you.

Do it yourself or let us help

You might well be able to do everything yourself, but you don't have to! Let us help make your wardrobe dream a reality with our service offers like picking, home delivery, assembly, financing and more. Read more at IKEA.sg or contact staff in the stores for more info.

All the products (shown here) may not be available at the store. Please contact the staff or look at IKEA.sg for more information. For more detailed product information, see the pricetag and the Internet. All units require assembly.



Choose your wardrobe

We have a wide range of PAX/KOMPLEMENT combinations to choose from which you can find in the store or on our website at IKEA.sg. If you don't find a pre-designed solution that you like, you can use our PAX/KOMPLEMENT planner to create the perfect solution that suits your needs and taste.

Begin by looking through the ready-made combinations on the web or in the planner gallery and choose one that inspires you. You will then have a pre-designed combination to start from that you can customise to your needs. You can, for example, change the size and the colour of the wardrobe, or the interior organisers.

You can also use the planner to design your own unique PAX/KOMPLEMENT combination from scratch. There are 3 simple steps to follow when choosing your wardrobe solution.

- 1. Choose frames.** Consider how much space you have available in your room. It's important to know the maximum height and width of your new wardrobe. Remember, you can also make the most of unused space with corner units.
- 2. Pick your style.** What colour do you want your wardrobe to be? We can offer a wide selection selection of doors in different colours.

3. Choose interior organisers. Think through your day-to-day needs. Do you have a lot of shoes? Then a pull out tray with shoe inserts could be a good option for you. Or perhaps you have a lot of trousers? Then a trouser hanger will come in handy. If you keep your summer and winter clothes in the same place, deep baskets will store your clothes neatly away.

Once you have decided on the interior organisers, it's time to add the finishing touches. Complete your new wardrobe with your choice of boxes and inserts from our extensive range of interior accessories. And for a really great result, don't forget the integrated lighting! Simple to install and makes it so much easier for you to find the right outfit.

The PAX/KOMPLEMENT planner helps you to calculate the price of your wardrobe and allows you to print or save a product list that you can bring to the store or use to buy online.

The planner can be found in the wardrobe area of the store or in the comfort of your own home. Just visit the wardrobe department on the IKEA website : IKEA.sg and go to the PAX/KOMPLEMENT wardrobe planner

Good to know measurements

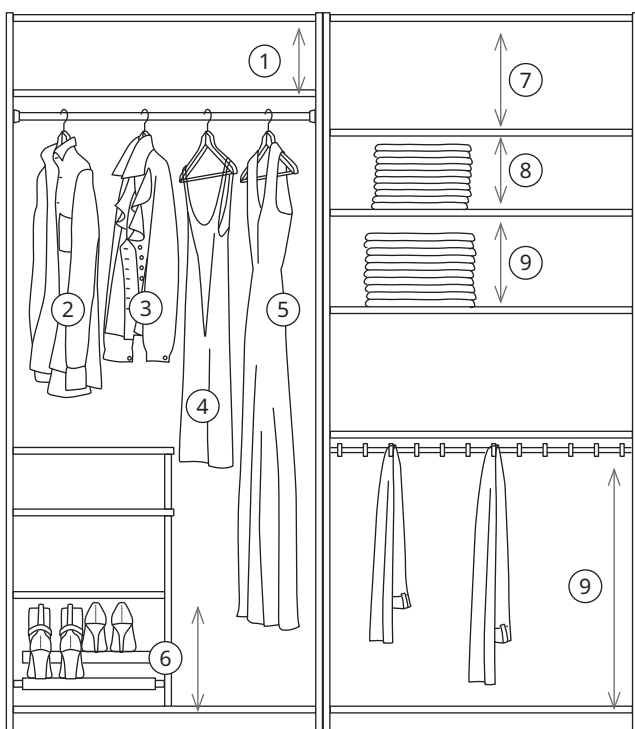

Hard to know how much space your clothes will take? Here's a useful guide of a few measurements and generic clothes sizes that could come in handy when planning your wardrobe.

1. Plan 19 cm to fit HEMMAFIXARE storage boxes.
2. Plan appr. 100 cm for coats.
3. Plan appr. 80 cm for blouses.
4. Short dresses needs appr. 120 cm.
5. Really long garments might need up to 190 cm.
6. Plan 33 cm for a pull-out shoe shelf.
7. Plan appr. 28 cm to fit a HEMMAFIXARE storage box.
8. Plan appr. 25 cm for 10 folded t-shirts.
9. Plan appr. 30 cm for 10 pairs of folded sweaters.
10. Plan appr. 60-70 cm for hanging trousers.

All frames and prices

Width×Depth×Height

10

The PAX Wardrobe system has a 10-year guarantee. Read more in the guarantee brochure.

Choose frames in the height, width and depth that suits your home. You can choose between 201 and 236 cm high frames, a depth of 35 or 58 cm and a width of 50, 75 and 100 cm. Available colors for each size are listed below.

Depth 35 cm, height 201 cm



Wardrobe frame 50×35×201 cm.		
White	503.551.21	\$90



Wardrobe frame 75×35×201 cm.		
White	003.551.33	\$120

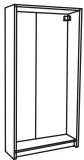

Wardrobe frame 100×35×201 cm.		
White	003.551.09	\$130

Depth 35 cm, height 236 cm



Wardrobe frame 50×35×236 cm.		
White	903.551.24	\$110

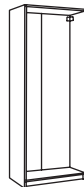

Wardrobe frame 75×35×236 cm.		
White	303.551.36	\$130



Wardrobe frame 100×35×236 cm.		
White	403.551.12	\$150

Depth 58 cm, height 201 cm



Wardrobe frame 50×58×201 cm.		
White	203.551.27	\$110
White stained oak effect	003.551.28	\$110
Beige	105.090.26	\$110
Dark grey	305.091.29	\$110

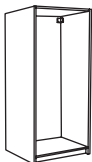

Wardrobe frame 75×58×201 cm.		
White	703.551.39	\$130
White stained oak effect	503.551.40	\$130
Beige	705.090.33	\$130
Dark grey	805.091.36	\$130

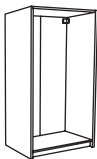

Wardrobe frame 100×58×201 cm.		
White	703.551.15	\$150
White stained oak effect	503.551.16	\$150
Beige	405.090.20	\$150
Dark grey	605.091.23	\$150

Depth 58 cm, height 236 cm



Wardrobe frame 50×58×236 cm.		
White	603.551.30	\$130
White stained oak effect	403.551.31	\$130
Beige	505.090.29	\$130
Dark grey	505.091.33	\$130



Wardrobe frame 75×58×236 cm.		
White	103.551.42	\$150
White stained oak effect	903.551.43	\$150
Beige	005.090.36	\$150
Dark grey	205.091.39	\$150

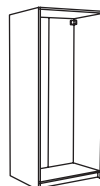

Wardrobe frame 100×58×236 cm.		
White	103.551.18	\$170
White stained oak effect	903.551.19	\$170
Beige	805.090.23	\$170
Dark grey	905.091.26	\$170

Create a corner solution

10 The PAX Wardrobe system has a 10-year guarantee. Read more in the guarantee brochure.

With this add-on unit for corner frame, you can also make use of the corners when building your wardrobe. It fits all frames in the PAX wardrobe system, so all you need to do is combine the add-on unit with the frame that suits your space best. No matter which depth or height you choose for your add-on unit, 4 adjustable shelves are always included. You can also complete

with 35 cm deep interior organisers from the KOMPLEMENT series to create exactly the wardrobe you've dreamed of.

Depth 35 cm, height 201 cm



Add-on unit for corner, 53×35×201 cm.

White	203.469.39	\$200
-------	------------	--------------

Depth 35 cm, height 236 cm



Add-on unit for corner, 53×35×236 cm.

White	603.469.42	\$230
-------	------------	--------------

Depth 58 cm, height 201 cm



Add-on unit for corner, 53×58×201 cm.

White	603.469.37	\$230
White-stained oak effect	003.469.59	\$230
Beige	305.151.11	\$230
Dark grey	405.151.20	\$230

Depth 58 cm, height 236 cm

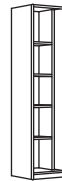

Add-on unit for corner, 53×58×236 cm.

White	003.469.35	\$250
White-stained oak effect	603.469.61	\$250
Beige	905.151.13	\$250
Dark grey	005.151.22	\$250

How to build

Here you can see how the add-on unit for corner frame can be used with other frames. The examples shown here are combinations that work together with hinged doors. For open storage

solutions, there are even more possibilities – please see more at IKEA.sg or ask a co-worker at your nearest IKEA store.

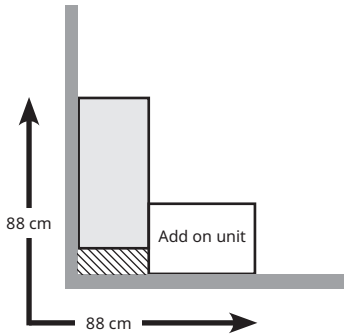

35 cm deep add-on unit for corner with one 75×35 cm frame.

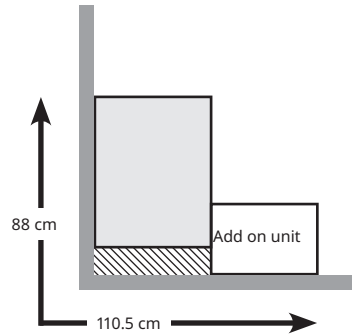

35 cm deep add-on unit for corner with one 75×58 cm frame.

Suggestion of interior organisers to use in this combination

Standard frame 75×35 cm:

Clothes rail 75×35 cm.
Shelf 75×35 cm.

Add-on unit for corner:

KOMPLEMENT interior organisers 35 cm depth.

Suggestion of interior organisers to use in this combination

Standard frame 75×58 cm:

Clothes rail 75×58 cm.
Shelf 75×58 cm.

Add-on unit for corner:

KOMPLEMENT interior organisers 35 cm depth.

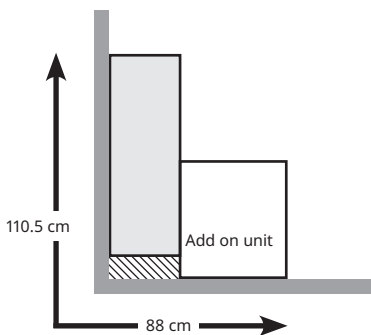

58 cm deep add-on unit for corner with one 100×35 cm frame.

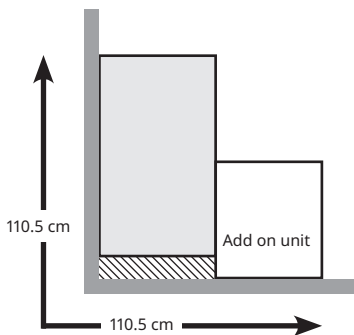

58 cm deep add-on unit for corner with one 100×58 cm frame.

Suggestion of interior organisers to use in this combination

Standard frame 100×35 cm:

Clothes rail 100×35 cm.
Shelf 100×35 cm.
Divider for frame 50cm with your choice of KOMPLEMENT interior.

Add-on unit for corner:

KOMPLEMENT interior organisers 35 cm depth.
Clothes rail 50×58 cm (turn the fitting around).

Suggestion of interior organisers to use in this combination

Standard frame 100×58 cm:

Clothes rail 100×58 cm.
Shelf 100×58 cm.
Divider for frame 50cm with your choice of KOMPLEMENT interiors.

Add-on unit for corner:

KOMPLEMENT interior organisers 35 cm depth.
Clothes rail 50×58 cm (turn the fitting around).

All hinged doors and prices

10

The PAX Wardrobe system has a 10-year guarantee. Read more in the guarantee brochure.

Handles and knobs are sold separately except where noted. See our complete range of knobs and handles in the stores or at IKEA.sg

All available hinged doors are listed below. Remember to pick up one 3-pack of KOMPLEMENT hinges for each 195 cm tall door, and one 4-pack of KOMPLEMENT hinges for each 229 cm

tall door. The soft closing hinges catches the door and close it slowly, silently and softly.



BERGSBO door.

White

50×195 cm	590.042.23	\$85
50×229 cm	890.042.50	\$100

Dark grey

50×195 cm	590.042.23	\$85
50×229 cm	890.042.50	\$100

White stained oak effect

50×229 cm	993.321.52	\$100
-----------	------------	--------------



FORSAND door.

White

25×195 cm	492.794.73	\$50
25×229 cm	992.794.75	\$60
50×195 cm	892.443.11	\$65
50×229 cm	492.443.13	\$80

White stained oak effect

50×195 cm	192.843.05	\$65
50×229 cm	792.843.07	\$80

Beige

50×195 cm	994.362.58	\$65
50×229 cm	594.362.60	\$80

Dark grey

50×195 cm	094.362.53	\$65
50×229 cm	594.362.55	\$80

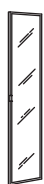

ÅHEIM door.

Mirror glass

25×195 cm	092.817.17	\$85
25×229 cm	492.817.20	\$100
50×195 cm	892.817.23	\$125
50×229 cm	192.817.26	\$150



FLISBERGET door.

Light beige

50×229 cm	791.810.69	\$70
-----------	------------	-------------



GRIMO door.

White

50×195 cm	791.835.82	\$85
50×229 cm	391.835.84	\$100



FARDAL door.

High-gloss white

25×195 cm	494.839.97	\$85
25×229 cm	294.839.98	\$100
50×195 cm	490.042.28	\$125
50×229 cm	090.042.54	\$150



KOMPLEMENT soft closing hinge.

For doors with a height of 195 cm.

3-pack	402.603.74	\$15
--------	------------	-------------

For doors with a height of 229 cm

4-pack	602.603.73	\$20
--------	------------	-------------



KOMPLEMENT soft closing hinge for add on corner unit.

For doors with a height of 195 cm.

6-pack	903.684.90	\$60
--------	------------	-------------

For doors with a height of 229 cm.

8-pack	303.684.93	\$70
--------	------------	-------------



TYSSDAL door.

White

50×195 cm	390.902.69	\$145
50×229 cm	990.902.71	\$170



TYSSDAL door.

White/glass

50×229 cm	091.719.50	\$190
-----------	------------	--------------



MISTUDDEN door.

Grey/patterned

50×195 cm	295.530.57	\$85
50×229 cm	695.530.60	\$100

All hinged doors and prices

Handles

The handles below are developed specially to fit doors for PAX wardrobes.



ORRNÄS handle, stainless steel, 1 pack.

170 cm	205.344.74	\$13.90
234 cm	305.344.78	\$16.90
330 cm	505.344.82	\$18.90

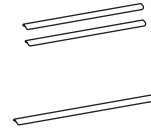

BILLSBRO handle, 2 pack.

120 cm	White	703.343.02	\$9
120 cm	Stainless Steel	903.236.18	\$9

BILLSBRO handle, stainless steel, 1 pack.

222 cm	White	403.343.08	\$26.90
222 cm	Stainless Steel	903.236.23	\$26.90

All sliding doors and prices

10

The PAX Wardrobe system has a 10-year guarantee. Read more in the guarantee brochure.

The sliding doors are sold in pairs. The size and price refers to the total measurement of the two doors together.

The soft opening and closing device is integrated into the rail for all sliding doors. It catches the running doors and makes sure they open and close slowly, silently and softly.



HASVIK pair of sliding doors. The soft open/closing mechanism is integrated into the rail.

White

150×201 cm	105.215.42	\$325
200×201 cm	405.215.45	\$375
150×236 cm	905.215.43	\$350
200×236 cm	205.215.46	\$395

High-gloss white

150×236 cm	405.215.50	\$450
200×236 cm	305.215.55	\$475

White stained oak

150×201 cm	505.215.59	\$325
200×201 cm	505.215.64	\$375
150×236 cm	105.215.61	\$350
200×236 cm	005.215.66	\$395

Dark grey

150×201 cm	705.109.51	\$325
200×201 cm	805.109.55	\$375
150×236 cm	305.109.53	\$350
200×236 cm	405.109.57	\$395



AULI/MEHAMN double sided, pair of sliding doors.

NOTE: The door is divided into three packages. Please use a picking list to ensure you collect one door frame and two packages of door panels. The soft open/closing mechanism is integrated into the rail.

Mirror/white stained oak with aluminium frame

150×201 cm	594.379.81	\$365
200×201 cm	394.379.96	\$445
150×236 cm	194.379.64	\$435
200×236 cm	594.380.04	\$525

Mirror/white stained oak with white frame

150×236 cm	194.379.64	\$435
200×236 cm	094.379.74	\$525

Mirror/beige with aluminium frame

150×201 cm	794.368.53	\$365
200×201 cm	294.368.60	\$445
150×236 cm	894.368.57	\$435
200×236 cm	694.368.63	\$525

Mirror/dark grey with black frame

150×236 cm	694.368.96	\$435
200×236 cm	494.369.01	\$525

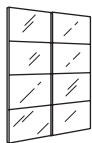

SVARTISDAL white paper effect, pair of sliding doors.

NOTE: The door is divided into three packages. Please use a picking list to ensure you collect one door frame and two packages of door panels. The soft open/closing mechanism is integrated into the rail.

White paper effect with white metal frame

150×201 cm	094.397.89	\$380
200×201 cm	094.397.94	\$470
150×236 cm	694.397.91	\$450
200×236 cm	594.397.96	\$540



GRIMO pair of sliding doors, white. The soft open/closing mechanism is integrated into the rail.

150×201 cm	005.215.28	\$375
200×201 cm	005.215.33	\$400
150×236 cm	605.215.30	\$400
200×236 cm	505.215.35	\$425

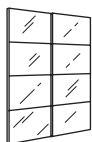

AULI mirror, pair of sliding doors. NOTE: The door is divided into three packages. Please use a picking list to ensure you collect one door frame and two packages of door panels. The soft open/closing mechanism is integrated into the rail.

Mirror with aluminium metal frame

150×201 cm	094.379.07	\$390
200×201 cm	894.379.13	\$460
150×236 cm	494.379.10	\$460
200×236 cm	194.379.16	\$550



MEHAMN double sided, pair of sliding doors. NOTE: The door is divided into three packages. Please use a picking list to ensure you collect one door frame and two packages of door panels. The soft open/closing mechanism is integrated into the rail.

White/white stained oak with white metal frame

150×201 cm	594.397.63	\$340
200×201 cm	394.397.78	\$430
150×236 cm	894.397.71	\$410
200×236 cm	694.397.86	\$500

Dark grey/beige with white metal frame

150×201 cm	994.362.63	\$340
200×201 cm	894.362.68	\$430
150×236 cm	494.362.65	\$410
200×236 cm	494.362.70	\$500

Create your own sliding door

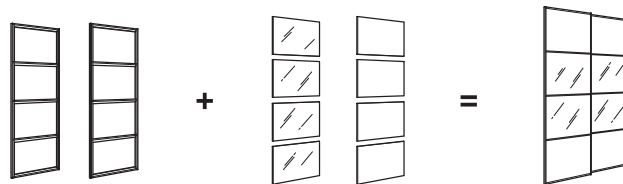
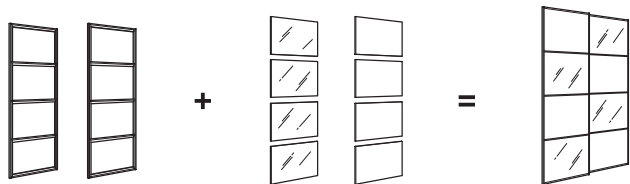
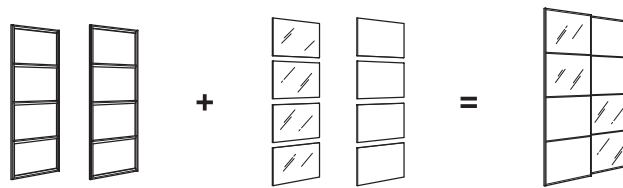
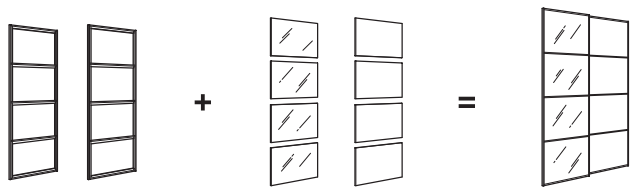

You can also choose your own combination of metal frames and panels for your sliding doors. The metal frame is available in white, black and aluminium and the panels come in a variety of materials and colours. Choose one frame and two packages of panels for each sliding door.

You will find all sliding door frames and panels on our website [IKEA.sg](https://www.ikea.sg)

You can also create your own sliding door in the PAX planning tool or contact staff at the PAX area in the store for more info.

Interior organisers

10

The PAX Wardrobe system has a 10-year guarantee. Read more in the guarantee brochure.

Organise all your shoes, ties, bed linen, lingerie, scarves, trousers, handbags, shoes, jewellery etc. The KOMPLEMENT range perfectly matches the different doors and frames in the PAX series.

Width and depth of KOMPLEMENT articles is stated to match the dimensions of the corresponding frame, actual dimensions vary.

Fits 35 cm deep frames



KOMPLEMENT clothes rail.

50×35 cm		
White	304.464.53	\$10
75×35 cm		
White	604.464.56	\$15
100×35 cm		
White	602.569.41	\$15

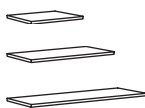

KOMPLEMENT shelf. For 50×35 cm

White	202.779.93	\$10
For 75×35 cm		
White	502.779.96	\$15
For 100×35 cm		
White	802.779.90	\$20



KOMPLEMENT mesh basket To be completed with KOMPLEMENT pull-out rail for basket 35 cm. Sold separately.

50×35 cm		
White	904.007.63	\$10
75×35 cm		
White	004.007.67	\$15
100×35 cm		
White	704.007.59	\$20

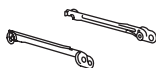

KOMPLEMENT pull-out rail for basket 35 cm, 2-p.		
White	102.632.46	\$5



KOMPLEMENT drawer.

50×35 cm		
White	503.550.22	\$40
75×35 cm		
White	803.550.25	\$45
100×35 cm		
White	103.550.19	\$50



KOMPLEMENT pull-out tray.

50×35 cm		
White	304.339.88	\$25
75×35 cm		
White	704.339.91	\$35
100×35 cm		
White	904.339.85	\$45



KOMPLEMENT pull-out trouser hanger.

50×35 cm		
White	604.465.50	\$35
75×35 cm		
White	004.465.53	\$45
100×35 cm		
White	204.465.47	\$55



KOMPLEMENT shoe shelf. 50×35 cm

White	402.572.58	\$10
-------	------------	-------------



75×35 cm		
White	602.572.62	\$15



100×35 cm		
White	302.572.54	\$20



KOMPLEMENT valet hanger, 17×5 cm.		
Dark grey	402.571.83	\$5
White	602.569.36	\$5



KOMPLEMENT drawer mat 90×30 cm. Easy to cut to the desired size.

Light grey	104.055.66	\$10
------------	------------	-------------

Interior organisers

10

The PAX Wardrobe system has a 10-year guarantee. Read more in the guarantee brochure.

Fits 58 cm deep frames



KOMPLEMENT clothes rail. 50 cm

Dark grey	202.569.43	\$5
White	102.568.92	\$5

75 cm

Dark grey	702.569.45	\$10
White	702.568.94	\$10

100 cm

Dark grey	602.569.41	\$15
White	502.568.90	\$15

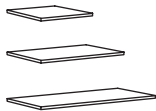

KOMPLEMENT shelf. For 50x58 cm

White	102.779.60	\$15
White stained oak effect effect	102.779.79	\$15
Beige	405.090.44	\$15
Dark grey	505.091.47	\$15

For 75x58 cm

White	702.779.62	\$20
White stained oak effect	702.779.76	\$20
Beige	505.090.48	\$20
Dark grey	705.091.51	\$20

For 100x58 cm

White	502.779.58	\$25
White stained oak effect effect	302.779.83	\$25
Beige	005.090.41	\$25
Dark grey	405.091.43	\$25

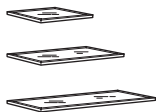

KOMPLEMENT glass shelf. For 50x58 cm

White	702.576.43	\$25
White stained oak effect	302.576.59	\$25
Beige	805.091.17	\$25
Dark grey	405.091.57	\$25

For 75x58 cm

White	302.576.40	\$35
White stained oak effect	002.576.65	\$35
Beige	205.091.20	\$35
Dark grey	805.091.60	\$35

For 100x58 cm

White	102.576.41	\$45
White stained oak effect	802.576.52	\$45
Beige	505.091.14	\$45
Dark grey	105.091.54	\$45

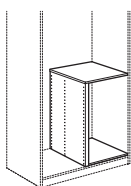

KOMPLEMENT divider for frames 75-100x58 cm. Fits 75 cm and 100 cm wide PAX frames, 58 cm deep.

White	703.550.16	\$55
White stained oak effect	503.550.17	\$55
Beige	905.091.07	\$55
Dark grey	805.092.16	\$55

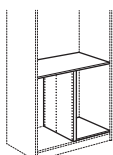

KOMPLEMENT divider for frames 100x58x81.5 cm.

White	403.550.13	\$65
White stained oak effect	203.550.14	\$65
Beige	105.091.11	\$65
Dark grey	205.092.19	\$65



KOMPLEMENT mesh basket. To be completed with KOMPLEMENT pull-out rail for basket 58 cm. Sold separately.

Dark grey	704.007.64	\$10
White	404.007.65	\$10

75x58 cm

Dark grey	804.007.68	\$15
White	604.007.69	\$15

100x58 cm

Dark grey	504.007.60	\$20
White	304.007.61	\$20

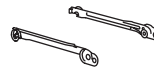

KOMPLEMENT pull-out rail for basket 58, 2-p.

Dark grey	402.632.35	\$5
White	902.632.47	\$5

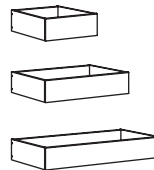

KOMPLEMENT drawer. 50x58 cm

White	803.550.68	\$45
White stained oak effect	603.550.69	\$45
Beige	405.090.77	\$45
Dark grey	005.091.97	\$45

75x58 cm

White	203.550.71	\$50
White stained oak effect	003.550.72	\$50
Beige	605.090.81	\$50
Dark grey	205.092.00	\$50

100x58 cm

White	403.550.65	\$55
White stained oak effect	203.550.66	\$55
Beige	305.090.73	\$55
Dark grey	705.091.94	\$55

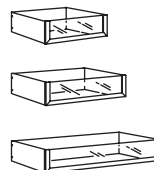

KOMPLEMENT drawer with glass front. 50x58 cm

White	603.550.31	\$55
White stained oak effect	403.550.32	\$55
Beige	305.090.87	\$55
Dark grey	905.092.06	\$55

75x58 cm

White	003.550.34	\$65
White stained oak effect effect	703.550.35	\$65
Beige	705.090.90	\$65
Dark grey	305.092.09	\$65

100x58 cm

White	203.550.28	\$75
White stained oak effect effect	003.550.29	\$75
Beige	005.090.84	\$75
Dark grey	605.092.03	\$75



KOMPLEMENT pull-out tray. Combines with different inserts and shoe racks, see organising accessories.

50x58 cm

White	602.463.63	\$35
White stained oak effect	802.463.57	\$35
Beige	405.091.00	\$35
Dark grey	905.091.88	\$35

75x58 cm

White	002.463.75	\$45
White stained oak effect	602.463.77	\$45
Beige	805.091.03	\$45
Dark grey	305.091.91	\$45

100x58 cm

White	502.463.87	\$55
White stained oak effect	102.463.89	\$55
Beige	205.090.97	\$55
Dark grey	505.091.85	\$55

Interior organisers

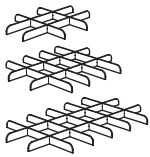

KOMPLEMENT divider for pull-out tray, felt.

50×58 cm	004.667.96	\$10
75×58 cm	604.667.98	\$15
100×58 cm	504.667.94	\$20

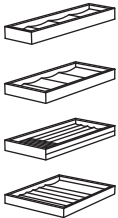

KOMPLEMENT insert for pull-out tray, light grey.
 To fit KOMPLEMENT pull-out tray 50×58 cm you will need: 1 KOMPLEMENT insert 25×58 cm and 1 KOMPLEMENT insert 15×58 cm or 1 KOMPLEMENT insert 40×58 cm. To fit KOMPLEMENT pull-out tray 75×58 cm you will need: 2 KOMPLEMENT inserts 25×58 cm and 1 KOMPLEMENT insert 15×58 cm or 1 KOMPLEMENT insert 25×58 cm and 1 KOMPLEMENT insert 40×58 cm. To fit KOMPLEMENT pull out tray 100×58 cm you will need: 2 KOMPLEMENT inserts 25×58 cm and 1 KOMPLEMENT insert 40×58 cm or 3 KOMPLEMENT inserts 25×58 cm and 1 KOMPLEMENT insert 15×58 cm.

15×53 cm with 4 compartments	004.057.60	\$20
25×53 cm with 4 compartments	704.057.71	\$30
25×53 cm for jewellery	904.057.65	\$30
40×53 cm with compartments	604.057.62	\$40



KOMPLEMENT pull-out trouser hanger. 50×58 cm

White	104.465.38	\$45
White stained oak effect	804.465.06	\$45
Beige	705.090.66	\$45
Dark grey	005.091.78	\$45

75×58 cm

White	504.465.41	\$55
White stained oak effect	204.465.09	\$55
Beige	105.090.69	\$55
Dark grey	205.091.82	\$55

100×58 cm

White	704.465.35	\$65
White stained oak effect	504.465.03	\$65
Beige	405.090.63	\$65
Dark grey	905.091.74	\$65

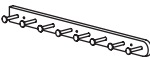

KOMPLEMENT pull-out multi-use hanger 58.

Dark grey	002.624.88	\$15
White	602.624.90	\$15



KOMPLEMENT valet hanger 17×5 cm.

Dark grey	402.571.83	\$5
White	602.569.36	\$5



KOMPLEMENT drawer mat 90×53 cm. Easy to cut to the desired size.

Light grey	104.055.66	\$10
------------	------------	-------------

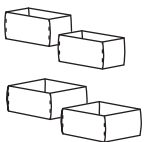

KOMPLEMENT box set of 2, light grey.

15×27×12 cm	204.057.78	\$14.90
25×27×12 cm	004.057.79	\$19.90

Interior accessories

Fits 35 cm deep frames



HEMMAFIXARE shoe box, 2-pack, 23×34×19 cm.
White/grey 505.039.23 **\$16.90**



HEMMAFIXARE storage case, 34×51×19 cm.
White/grey 305.039.24 **\$14.90**

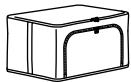

HEMMAFIXARE storage case, 34×51×28 cm.
White/grey 805.039.12 **\$16.90**



SKUBB shoe box, 22×34×16 cm, 4-p.
White 801.863.96 **\$14.90**
Dark grey 004.729.81 **\$14.90**



SKUBB box, set of 6.
White 204.285.53 **\$8.50**



TJENA storage box with lid, 25×35×20 cm
White 203.954.25 **\$5.50**

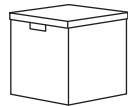

32×35×32 cm
White 604.693.01 **\$9.50**



TJOG storage box with lid, 25×36×15 cm
Dark grey 204.776.66 **\$7.50**

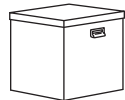

32×31×30 cm
Dark grey 004.776.72 **\$9.50**



KOMPLEMENT multi-use hanger, white.
32×72 cm 203.872.08 **\$9**

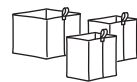

RAGGISAR basket, grey, s3. 2 pcs 19×13×18 cm and 1 pc 25×25×18 cm.
703.480.21 **\$7.50**



RAGGISAR tray, dark grey.
40×30 cm 803.480.25 **\$14.90**

Fits 58 cm deep frames



HEMMAFIXARE shoe box, 2-pack, 23×34×19 cm.
White/grey 505.039.23 **\$16.90**



HEMMAFIXARE storage case, 34×51×19 cm.
White/grey 305.039.24 **\$14.90**

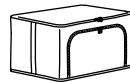

HEMMAFIXARE storage case, 34×51×28 cm.
White/grey 805.039.12 **\$16.90**

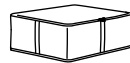

HEMMAFIXARE storage case, 44×51×19 cm.
White grey 005.039.11 **\$19.90**



HEMMAFIXARE storage case, 69×51×19 cm.
White grey 105.039.20 **\$24.90**



SKUBB shoe box, 22×34×16 cm, 4-p.
White 801.863.96 **\$14.90**
Dark grey 004.729.81 **\$14.90**



SKUBB box, set of 6.
White 204.285.53 **\$8.50**



TJOG storage box with lid, 35×56×30 cm.
Dark grey 604.776.69 **\$19.90**



KOMPLEMENT multi-use hanger, white.
32×72 cm 203.872.08 **\$9**

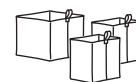

RAGGISAR basket, grey, set of 3. 2 pcs 19×13×18 cm and 1 pc 25×25×18 cm.
703.480.21 **\$7.50**

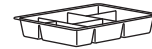

RAGGISAR tray.
40×30 cm 803.480.25 **\$14.90**



TJENA storage box with lid, 35×50×30 cm
White 403.743.56 **\$14.90**



KUGGIS box with lid, 37×54×21 cm
White 402.802.06 **\$24.90**

Integrated lighting all parts and prices



ÖVERSIDAN LED wardrobe lighting strip with sensor.

46 cm		
Beige	205.315.74	\$20
White	505.315.77	\$20
Dark grey	905.315.75	\$20
71 cm		
Beige	305.315.78	\$25
White	705.315.81	\$25
Dark grey	105.315.79	\$25
96 cm		
Beige	505.315.82	\$30
White	305.315.83	\$30
Dark grey	105.315.84	\$30

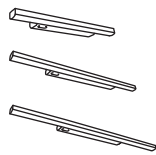

STÖTTA LED lighting strip. White. Easy to place anywhere as it is battery operated and does not need to be connected to the mains supply. The light switches on and off automatically when you open or close the door so no energy is wasted. Batteries are sold separately; 2 pcs for the 32 cm. IKEA recommends LADDA rechargeable batteries. Only for wardrobes with hinged doors.

32 cm	503.600.85	\$15
52 cm	903.600.88	\$20
72 cm	303.600.91	\$25



TVÄRDRAG cabinet lighting. The traditional expression of the lamp goes nicely with the cabinets in the HAVSTA and HAUGA series. The metal shade creates a direct light that illuminates your cabinet or wardrobe. If you want the lamp's light to be directed into your display cabinet, just angle the lamp head inwards. Provides a focused light that is good for lighting smaller areas. You can dim your lighting wirelessly and easily adapt the lighting based on activity. The bracket makes it possible to slide the lamp back and forth. You easily attach it with screws – or with double-sided adhesive tape on glass and metal surfaces. The LED light source consumes up to 85% less energy and lasts 20 times longer than incandescent bulbs. You can turn up to 6 light sources on and off simultaneously if you complete with ANSLUTA driver. If you also want to be able to dim, choose TRÅDFRI driver and remote control instead. Sold separately.

Black	305.314.51	\$30
-------	------------	------

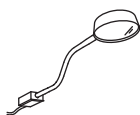

YTBERG cabinet lighting. The lamp's slim and neat design goes with most styles and is perfect if space is limited between the top of your wardrobe or cabinet and the ceiling. You can easily direct the light where you like since the flexible gooseneck arm can be bent and angled – perfect when it's time for homework, arts and crafts or cuddling up with a good book. Spreads a soft light that creates a cosy atmosphere in the room. The bracket makes it possible to slide the lamp back and forth. You easily attach it with screws – or with double-sided adhesive tape on glass and metal surfaces. You can dim your lighting wirelessly and easily adapt the lighting based on activity. The LED light source consumes up to 85% less energy and lasts 20 times longer than incandescent bulbs. You can easily direct the light where you like since the arm can be bent 180° and the lamp head angled 90°. You can turn up to 6 light sources on and off simultaneously if you complete with ANSLUTA driver. If you also want to be able to dim, choose TRÅDFRI driver and remote control instead. Sold separately.

Black	405.314.41	\$20
White	005.314.43	\$20

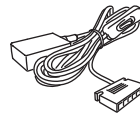

ANSLUTA LED driver with cord, 19W. ANSLUTA driver for On/Off only function.

White	804.058.41	\$15
-------	------------	------

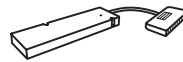

TRÅDFRI LED driver. To be completed with FÖRNIMMA power supply cord, sold separately. Can be used with TRÅDFRI remote control and TRÅDFRI gateway.

Up to 30W, connect up to 10 units.	305.403.56	\$3
------------------------------------	------------	-----

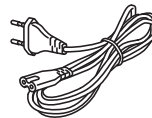

FÖRNIMMA power supply cord. For connection to the TRÅDFRI LED driver.

3.5 m	104.468.83	\$10
-------	------------	------

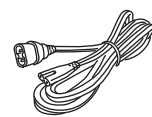

FÖRNIMMA intermediate connection cord. Can be used as a direct connection between TRÅDFRI LED drivers, e.g. between two sections of wall cabinets, with one single connection to the mains supply.

2 m	303.946.99	\$7
-----	------------	-----



STYRBAR wireless dimmer.

Stainless steel	004.636.08	\$20
White	104.883.64	\$15



DIRIGERA hub for smart products. Together with the IKEA Home smart app, the DIRIGERA hub brings the most benefits to your smart home.

	505.034.09	\$119
--	------------	-------

How to choose integrated lighting

Now you don't need to worry about getting bright light in your eyes or it waking up your partner when you look for clothes. Instead, you start the day when you open your wardrobe and the soft light from our LED lighting strips turns on. Or choose cabinet lighting placed on top of the wardrobe to help you see

what's on the top shelf also provides a nice and cosy atmosphere in the entire room when the wardrobe doors are closed. You can even connect to IKEA Smart lighting using the TRÅDFRI gateway.

Basic parts

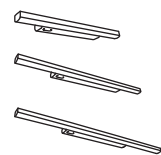

STÖTTA LED lighting strips.



LADDA batteries

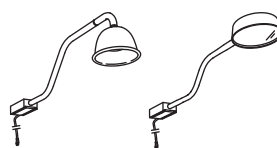
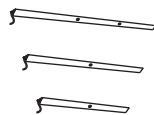

TVÄRDAG or YTBERG or ÖVERSIDAN

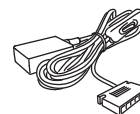

ANSLUTA for ON/OFF function

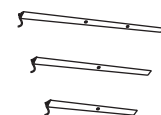

TVÄRDAG, YTBERG or ÖVERSIDAN

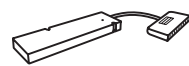

TRÅDFRI LED driver



FÖRNIMMA connection cord



FÖRNIMMA power supply cord



STYRBAR or TRÅDFRI wireless dimmer/remote control for more lights function



TRÅDFRI Gateway

See All parts and prices list for more information about each product.

How to choose a driver

There are two LED drivers. Choose based on how many units you want to connect. You can connect up to 3 units to the 10W LED driver, as long as the total wattage does not exceed 10W. The 30W LED driver can support up to 10 units, max. wattage 30W.

You can connect up to 10 drivers in one installation cord. Flashing lights indicate that the maximum wattage of the LED driver is exceeded. If you want to use more than one LED driver,

make sure to synchronise each LED driver with the TRÅDFRI remote control so that the entire combination can be dimmed at the same time.

Make your cabinet lighting smart by adding the TRÅDFRI gateway. With the gateway, you can control your lights from the IKEA Home smart app and create a mood together with your other TRÅDFRI lighting.

On/off function

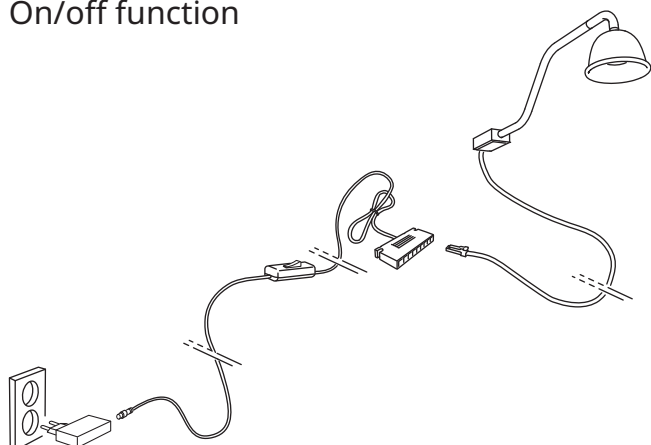

Dimming function

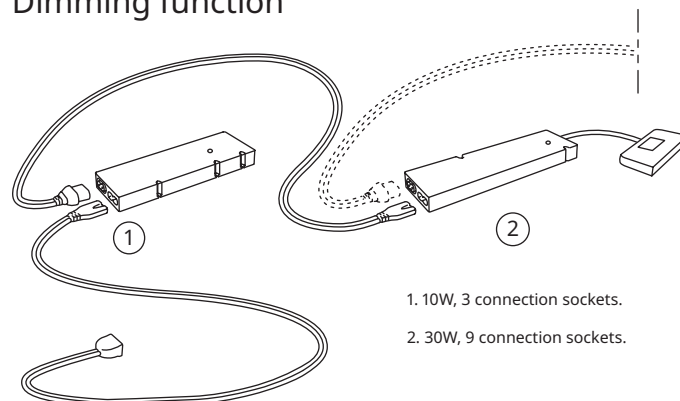

1. 10W, 3 connection sockets.
2. 30W, 9 connection sockets.

How to build integrated lighting

ÖVERSIDAN lighting strips

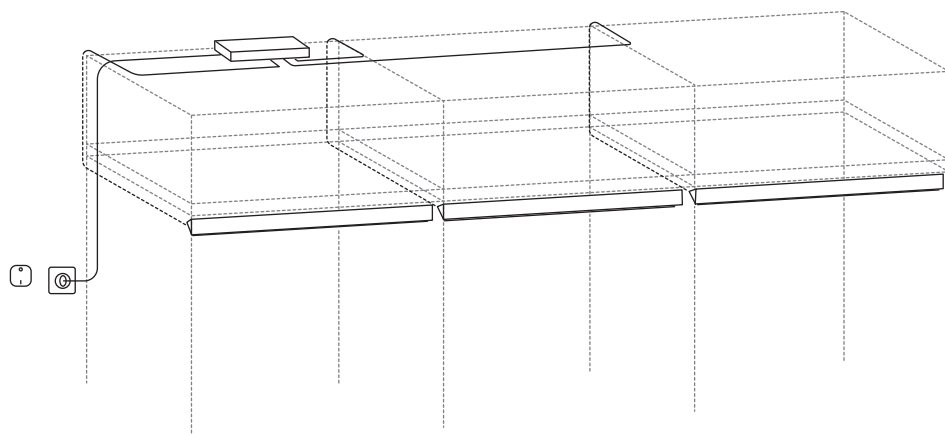

Cabinet lighting

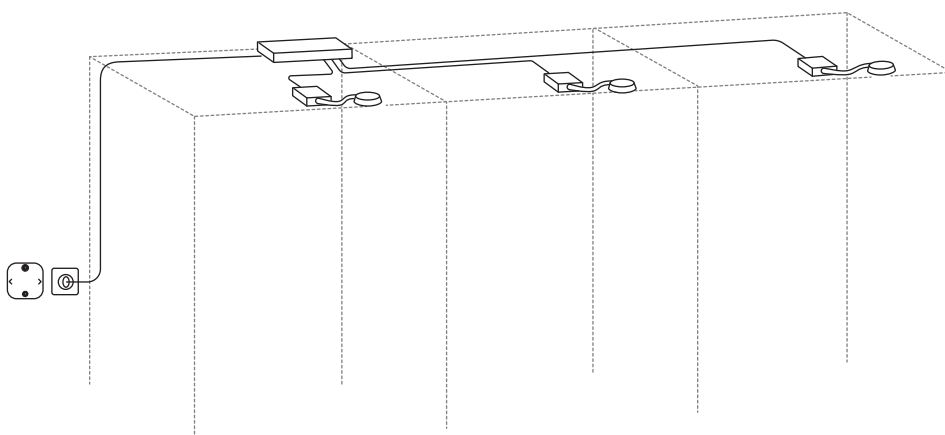

ÖVERSIDAN and cabinet lighting with smart lighting remote

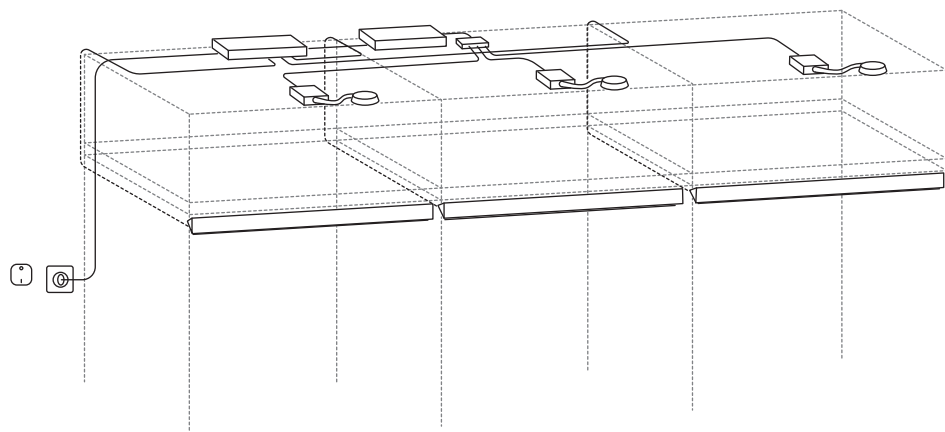

Integrated lighting solutions – combination examples

Here you can find some integrated lighting solutions for the PAX wardrobe. In these solutions we placed the ÖVERSIDAN lighting strips to help you to find everything you are looking for

in your beautiful new wardrobe. Remember that you can personalize your lighting solution based on your personal needs.

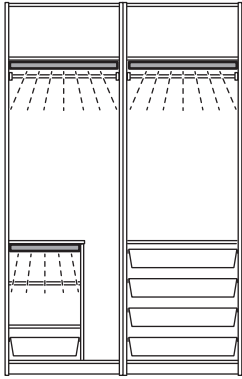

PAX combination, total size: W150×D66×H236 cm.
Complete the combination with



ÖVERSIDAN/TRÅDFRI lighting kit.

White	394.972.40	\$115
Beige	594.972.39	\$115

Parts included in this lighting kit:

ÖVERSIDAN LED wardrobe strip with sensor, 71 cm, dimmable	2 pcs
ÖVERSIDAN LED wardrobe strip with sensor, 46 cm, dimmable	1 pc
TRÅDFRI driver for wireless control, 30W	1 pc
FÖRNIMMA power supply cord, 3.5 m	1 pc

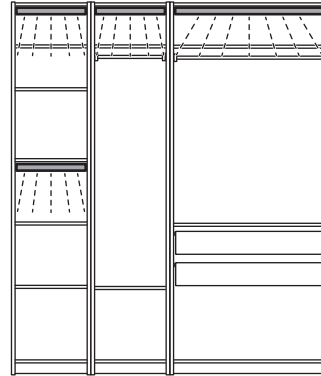

PAX combination, total size: W200×D60×H236 cm.
Complete the combination with

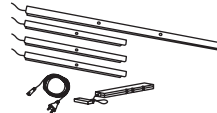

ÖVERSIDAN/TRÅDFRI lighting kit.

Dark grey	894.962.57	\$135
-----------	------------	--------------

Parts included in this lighting kit:

ÖVERSIDAN LED wardrobe light strip with sensor, 46 cm, dimmable	3 pcs
ÖVERSIDAN LED wardrobe light strip with sensor, 96 cm, dimmable	1 pc
TRÅDFRI driver for wireless control, 30W	1 pc
FÖRNIMMA power supply cord, 3.5 m	1 pc

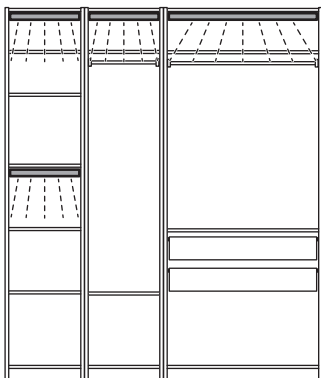

PAX combination, total size: W200×D60×H236 cm.
Complete the combination with

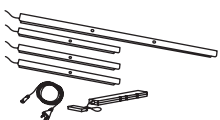

ÖVERSIDAN/TRÅDFRI lighting kit.

Dark grey	894.962.57	\$135
-----------	------------	--------------

Parts included in this lighting kit:

ÖVERSIDAN LED wardrobe light strip with sensor, 46 cm, dimmable	3 pcs
ÖVERSIDAN LED wardrobe light strip with sensor, 96 cm, dimmable	1 pc
TRÅDFRI driver for wireless control, 30W	1 pc
FÖRNIMMA power supply cord, 3.5 m	1 pc

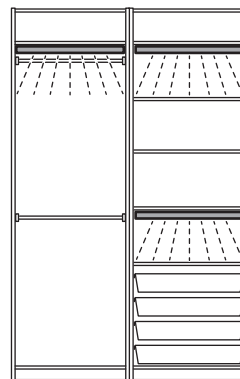

PAX combination, total size: W150×D66×H236 cm.
Complete the combination with

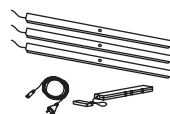

ÖVERSIDAN/TRÅDFRI lighting kit.

White	794.972.24	\$120
Beige	194.972.22	\$120
Dark grey	994.972.23	\$120

Parts included in this lighting kit:

ÖVERSIDAN LED wardrobe strip with sensor, 71 cm, dimmable	3 pcs
TRÅDFRI driver for wireless control, 10W	1 pc
FÖRNIMMA power supply cord, 3.5 m	1 pc

Integrated lighting solutions – combination examples

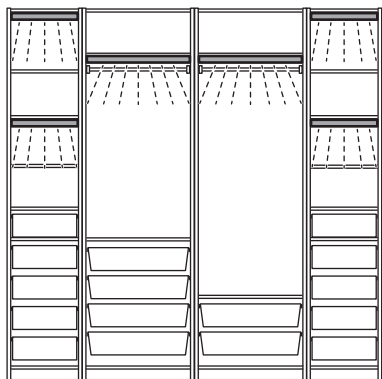

PAX combination, total size: W250×D66×H236 cm.
Complete the combination with

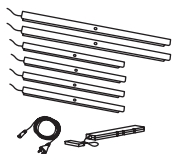

ÖVERSIDAN/TRÅDFRI lighting kit.

White 294.972.26 **\$175**

Parts included in this lighting kit:

ÖVERSIDAN LED wardrobe strip with sensor, 71 cm, dimmable	2 pcs
ÖVERSIDAN LED wardrobe strip with sensor, 46 cm, dimmable	4 pcs
TRÅDFRI driver for wireless control, 30W	1 pc
FÖRNIMMA power supply cord, 3.5 m	1 pc

Over the cabinet lighting

TVÄRDRAG and YTBERG are cabinet's best friend – it lights things up and spread a soft light that create a cosy atmosphere in the room. It also provides a focused light that is good

for lighting smaller areas. Use it on top of a wardrobe in the bedroom, or together with storage in the living room, kitchen or hallway.

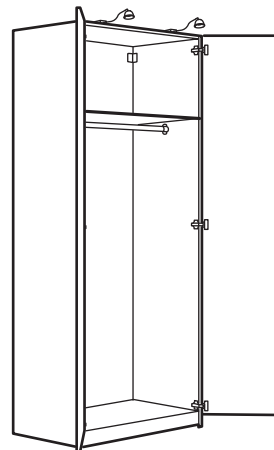
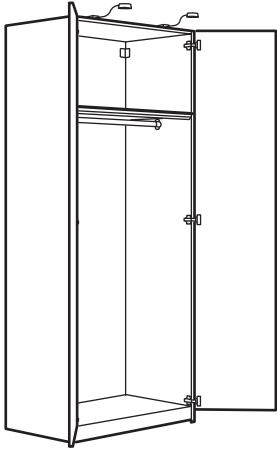

YTBERG combination.

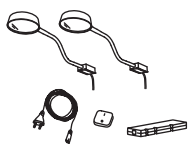

YTBERG/TRÅDFRI lighting kit*.

TVÄRDRAG combination

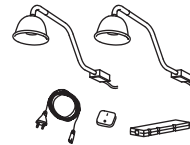

YTBERG/TRÅDFRI lighting kit*.

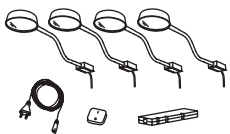

YTBERG/TRÅDFRI lighting kit*.

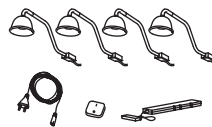

YTBERG/TRÅDFRI lighting kit*.

*Please refer to page 14 'Integrated lighting all parts and prices' for further info.