

STUGVIK

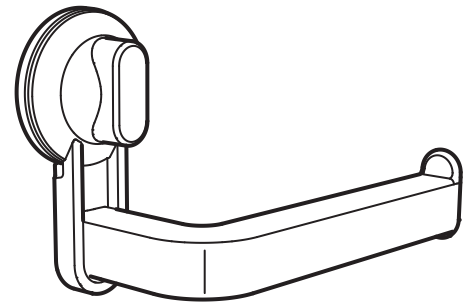

Design and Quality
IKEA of Sweden

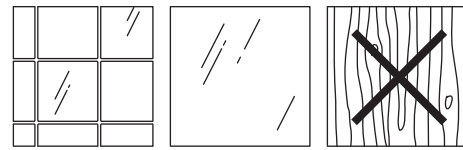
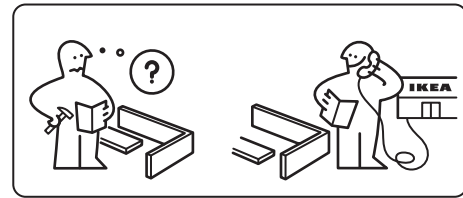

1

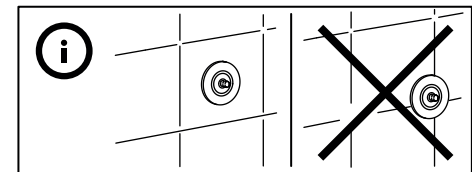
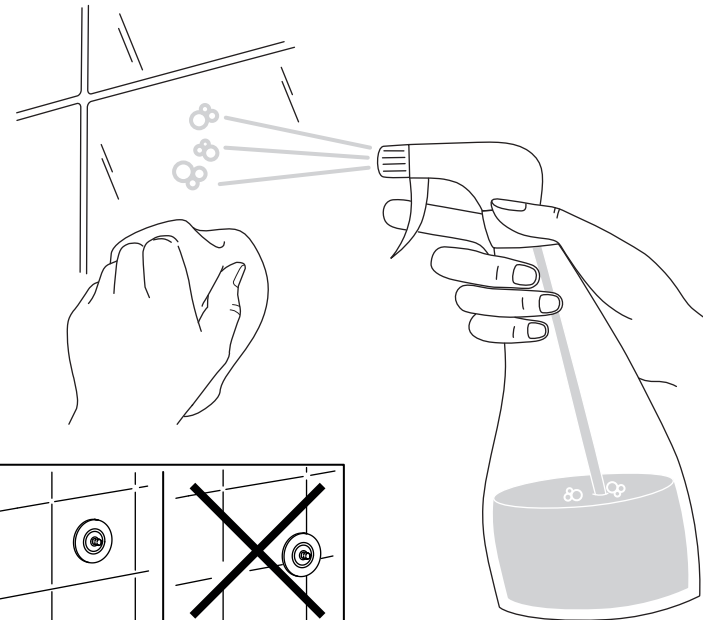

2

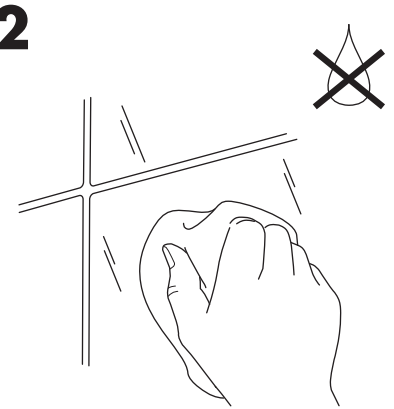

3

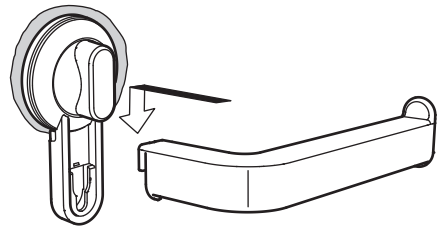

4

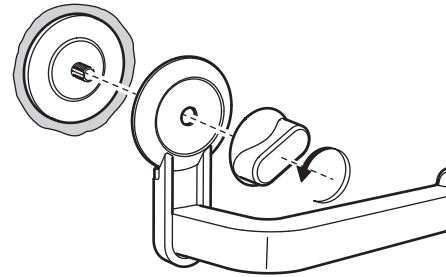

5

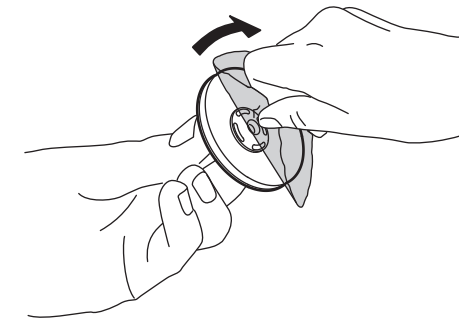

© Inter IKEA Systems B.V. 2015

2016-11-30
AA-1654680-2

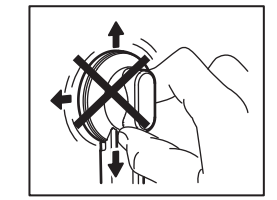
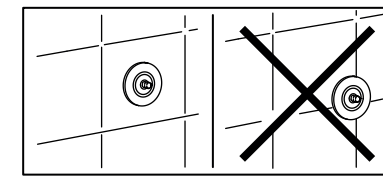
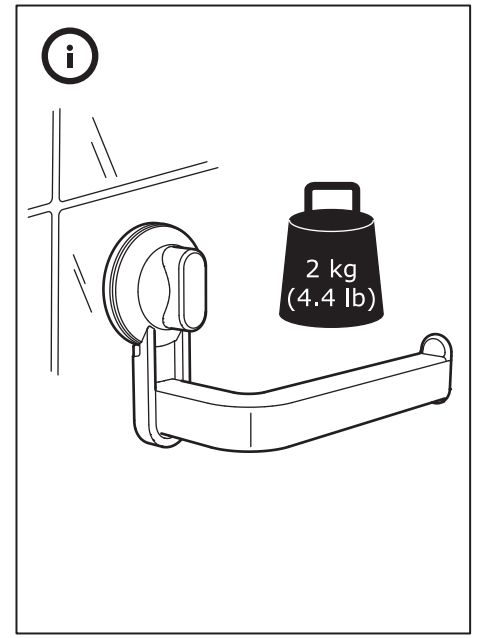
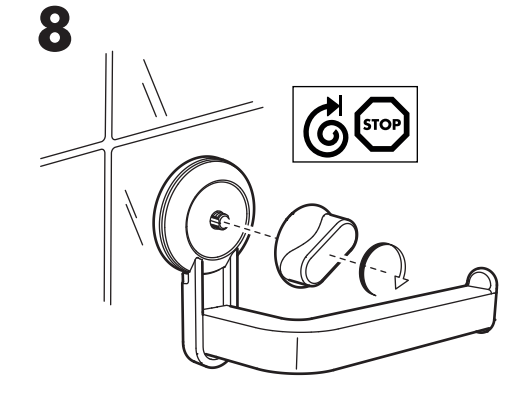
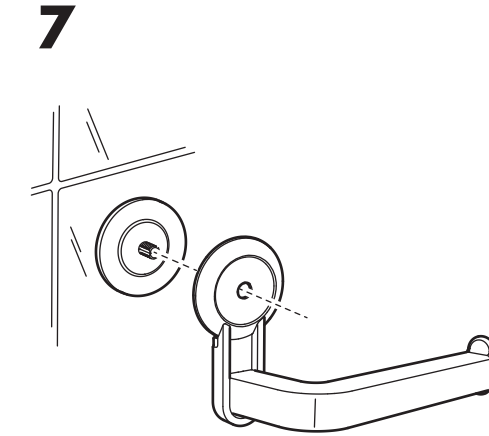
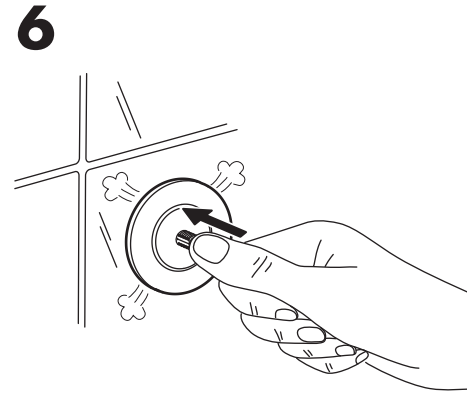

2 kg
(4.4 lb)