

### English

Wipe clean with a soft cloth dampened in water and a mild non-abrasive washing-up detergent or soap, if necessary. Wipe dry with a clean cloth.

**How to handle your products with protective film**

- Before assembly, remove protective film from edges and other surfaces which may interfere with assembly.
- Leave remaining protective film to avoid damage during assembly. After assembly, remove all protective film.
- Note – surfaces may be extra sensitive to scratches immediately after removing the protective film.
- To further improve resistance to scratches, wipe surfaces with a mild soap solution (max. 1%, no alcohol or abrasives).

### Deutsch

Mit einem in Wasser angefeuchteten weichen Tuch und, wenn nötig, mit schleifmittelfreiem Reinigungsmittel oder Seifenlösung säubern. Mit einem sauberen Tuch abtrocknen.

**Behandlung von Produkten mit Schutzfolie**

- Vor der Montage die Schutzfolie von der Kante und anderen Oberflächen entfernen, wo sie bei der Montage störend sein könnte.
- Die übrige Schutzfolie am Produkt belassen, um Schäden beim Montieren zu vermeiden. Die Schutzfolie nach der Montage komplett entfernen.
- Bitte beachten - direkt nach Entfernen der Schutzfolie kann die Oberfläche besonders empfindlich gegen Kratzer sein.
- Zur Erhöhung der Strapazierfähigkeit die Oberfläche mit einem weichen Tuch und einer milden Seifenlauge (max. 1%; keine alkoholhaltigen Mittel oder Schleifmittel) abwischen.

### Français

Nettoyer à l'aide d'un chiffon doux imbibé d'eau et, si besoin, d'un détergent non abrasif ou de savon. Essuyer avec un chiffon propre.

**Que faire du film protecteur sur les produits.**

- Avant le montage, retirer le film de protection qui pourrait gêner, notamment au niveau des coins ou sur certaines surfaces.
- Laisser le film de de protection s'il ne gêne pas, afin d'éviter tout risque de dommages lors du montage. Après le montage, retirer tout le film protecteur.
- Attention : une fois le film retiré, la surface craint particulièrement les rayures.
- Pour renforcer la résistance à l'usure, nettoyer à l'aide d'un chiffon doux trempé dans de l'eau savonneuse (max. 1 % de détergent).

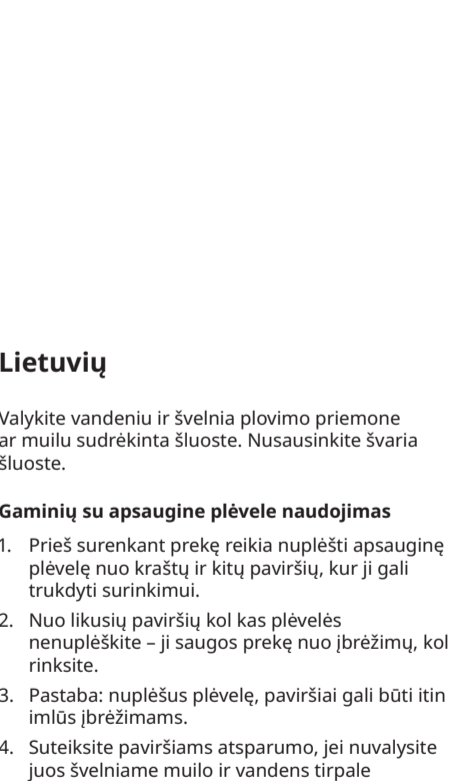
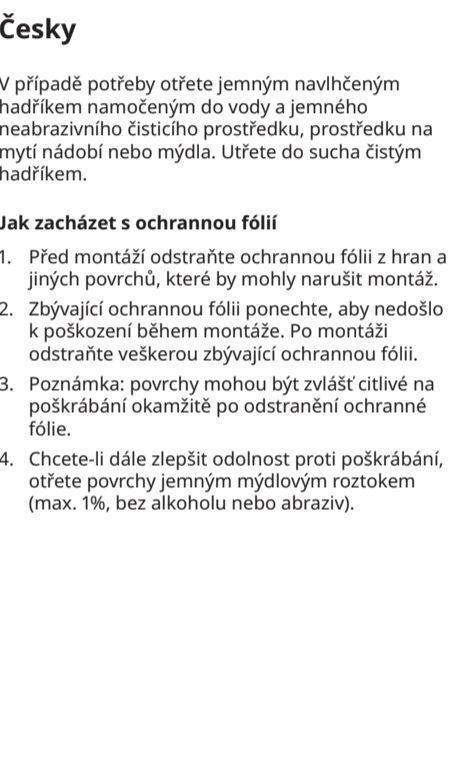

### Nederlands

Schoonmaken met een vochtig doekje met water en evt. een schoonmaakmiddel zonder schuurmiddel, of een zeepoplossing. Nadrogen met een droge doek.

**Omgaan met producten met beschermfolie**

- Voor de montage: verwijder de beschermfolie van de randen en andere oppervlakken die de montage kunnen belemmeren.
- Laat de resterende beschermfolie zitten om beschadigingen tijdens de montage te voorkomen.
- Let op - oppervlakken kunnen meteen nadat de beschermfolie verwijderd is extra gevoelig zijn voor krassen.
- Om de slijtvastheid nog verder te verbeteren, de oppervlakken afnemen met een milde zeepoplossing (max. 1 %, geen alcohol of schuurmiddel).

## Dansk

Tørres eventuelt af med en blød, fugtig klud tilsat et mildt, ikke-slibende opvaskemiddel eller sæbe. Tør efter med en ren, tør klud.

**Sådan håndterer du produkter med beskyttelsesfilm**

- Før du samler produktet, skal du fjerne beskyttelsesfilmen fra kanter og andre overflader, der kan vanskeliggøre monterng.
- Lad beskyttelsesfilmen sidde de øvrige steder, så du ikke beskadiger produktet under monterng. Fjern al beskyttelsesfilm efter monterng.
- BEMÆRK!** Umiddelbart efter at du har fjernet beskyttelsesfilmen, kan overfladen være særligt modtagelig over for ridser.
- For at gøre overfladen stærkere, skal du tørre den af med en blød klud og en mild sæbeopløsning (maks. 1%, ingen alkohol eller slipemidler).

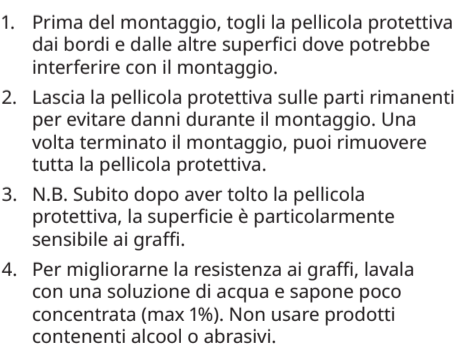

## Íslenska

Þrífðu með mjúkum rökum klút og mildu hreinsiefni án svarfefna eða sápu, ef nauðsyn krefur. Þurrkaðu með hreinum klút.

**Meðhöndlun vara með varnarfilmu**

- Fjarlægðu filmuna af brúnum og öðru yfirborði sem gæti haft áhrif á samsetninguna.
- Skildu þá filmu sem eftir er til að koma í veg fyrir skemmdir meðan þú setur saman vöruna. Eftir samsetningu skal fjarlægja alla varnarfilmu.
- Athugaðu – yfirborð gæti verið mjög viðkvæmt fyrir rispum rétt eftir að filman hefur verið fjarlægð.
- Þurrkaðu yfirborðið með mildri sápulausn (háms. 1%, án alkóhóls eða svarfefna) til að auka þol yfirborðsins gegn rispum.

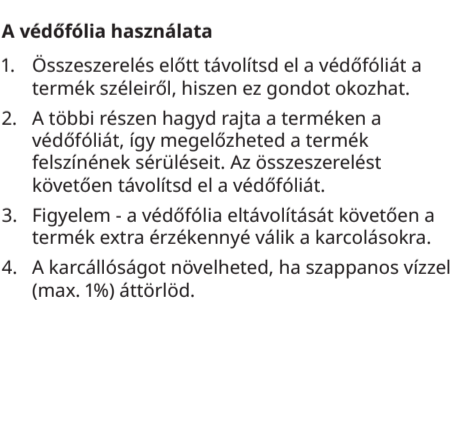

## Norsk

Tørk av med en myk klut fuktet med vann og litt mildt oppvaskemiddel eller såpe om nødvendig. Tørk over med en ren klut.

**Slik håndterer du produkter med beskyttelsesfilm**

- Før monterng må all beskyttelsesfilm fjernes fra kanter og andre flater som kan komme i veien under monterng.
- Behold den øvrige beskyttelsesfilmen for å unngå å skade produktet under monterng. Etter monterng, all beskyttelsesfilm fjerne.
- Merk – flatene kan være ekstra mottagelige for skraper umiddelbart etter at beskyttelsesfilmen er fjernet.
- For å styrke motstanden mot riper ytterligere, kan overflaten tørkes over med mildt såpevann (maks 1 %, uten alkohol eller slipemiddel).

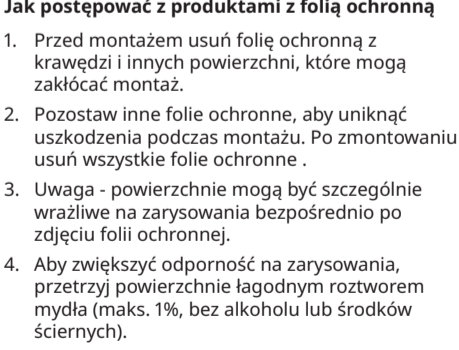

## Suomi

Pyyhitään pehmeällä, veteen kostutetulla liinalla. Tarvittaessa voidaan käyttää mietoaa puhdistusainetta, joka ei sisällä hankaavia ainesosia. Kuivataan puhtaalla liinalla.

**Suojakalvillisten tuotteiden käsittely**

- Poista ennen kokoamisen aloittamista suojakalvo tuotteen reunosta ja muista pinnoista, joissa se voi häiritä kokoamista.
- Jätä loput suojakalvot paikalleen vaurioiden välttämiseksi kokoamisen aikana. Poista loput suojakalvot, kun kokoaminen on suoritettu.
- Huomioi, että pinnat voivat olla erityisen herkkiä naarmuille heti suojakalvon poistamisen jälkeen.
- Naarmunkeston parantamiseksi pyyhi pinnat miedolla saippualluoksella (enintään 1 %, ei alkoholia tai hankaavia aineita).

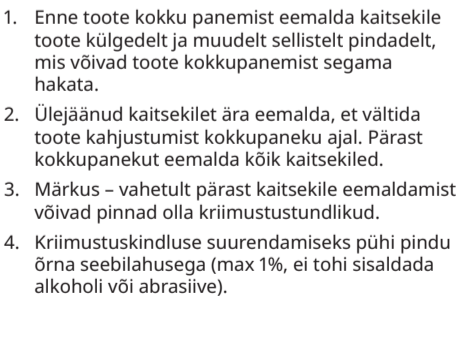

## Svenska

Rengör med mjuk trasa fuktad i vatten och ev. rengöringsmedel utan slipmedel eller tvålösning. Eftertorka med torr trasa.

**Så hanterar du dina produkter med skyddsfiln**

- Innan monterng, ta bort skyddsfiln från kanter och andra ytor som kan störa monterngen.
- Låt resterande skyddsfiln sitta kvar för att undvika skador under monterngen. Efter monterng, ta bort all skyddsfiln.
- Obs – yterna kan vara extra känsliga för repor direkt efter att skyddsfilmen tagits bort.
- För att förbättra tåligheten ytterligare, torka av yterna med mild tvålösning (max 1%, ingen alkohol eller slipmedel).

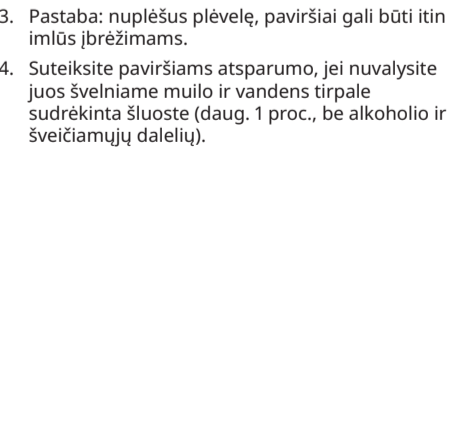
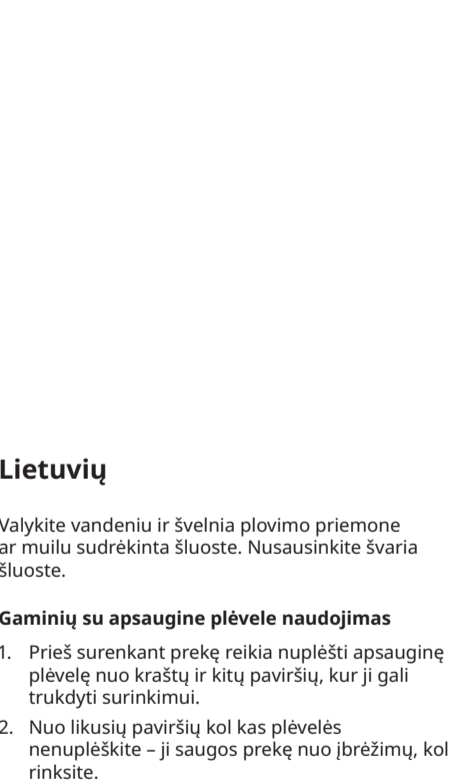
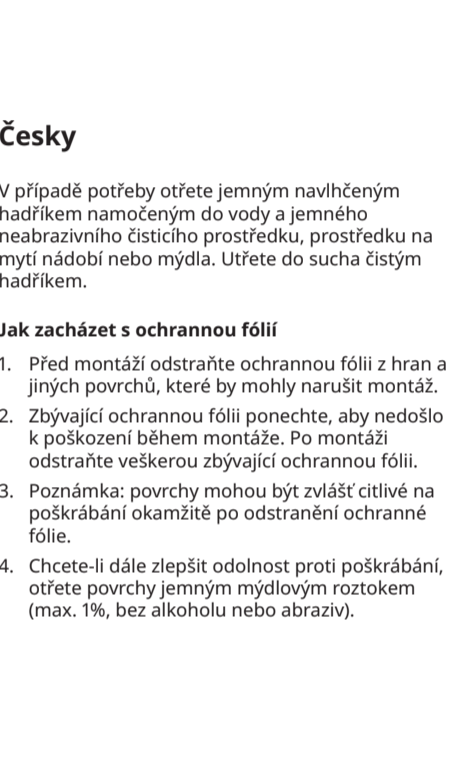
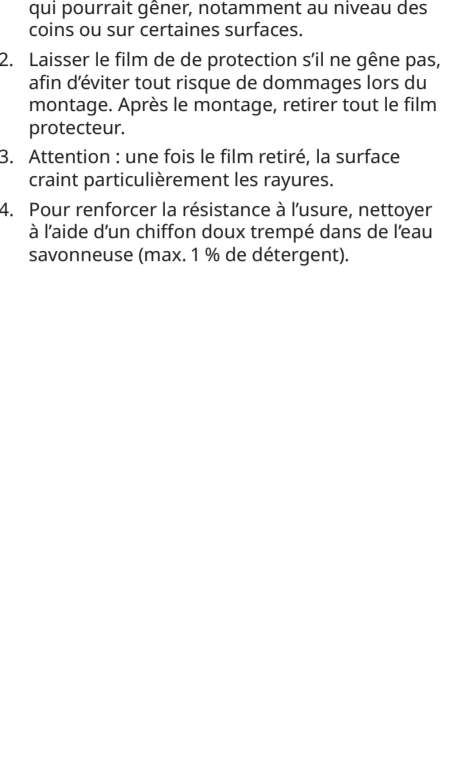
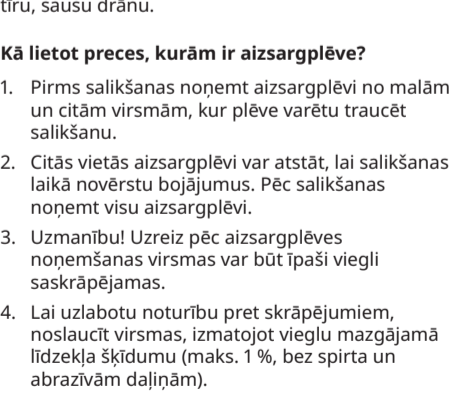

## Español

Limpiar con un paño suave humedecido en una solución de agua y un detergente neutro o jabón delicado, si fuese necesario. Secar con un paño limpio.

**Productos con película protectora**

- Antes de montar el producto, quita la película protectora de los bordes y todas las superficies que puedan dificultar la tarea.
- Deja el resto de la película protectora hasta que acabes de montar el producto para evitar provocar daños durante el proceso.
- Importante: algunas superficies son más sensibles a los arañazos justo después de retirar la película protectora.
- Para mejorar la resistencia a los arañazos, limpia las superficies con una solución jabonosa suave (1% máximo, sin alcohol ni productos abrasivos).

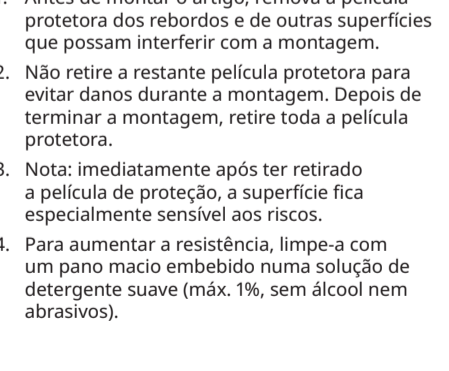

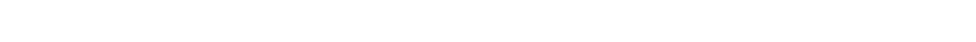
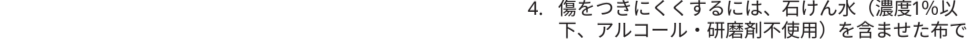
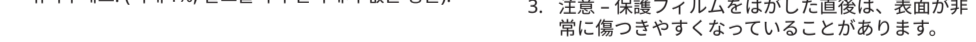
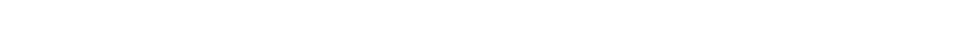
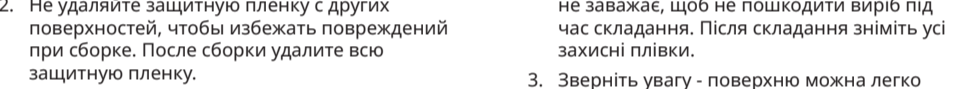
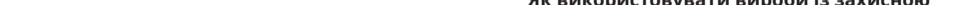
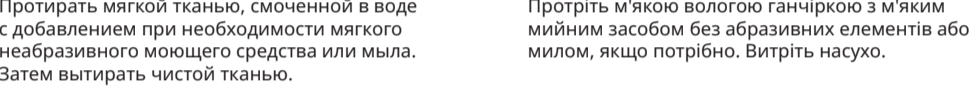
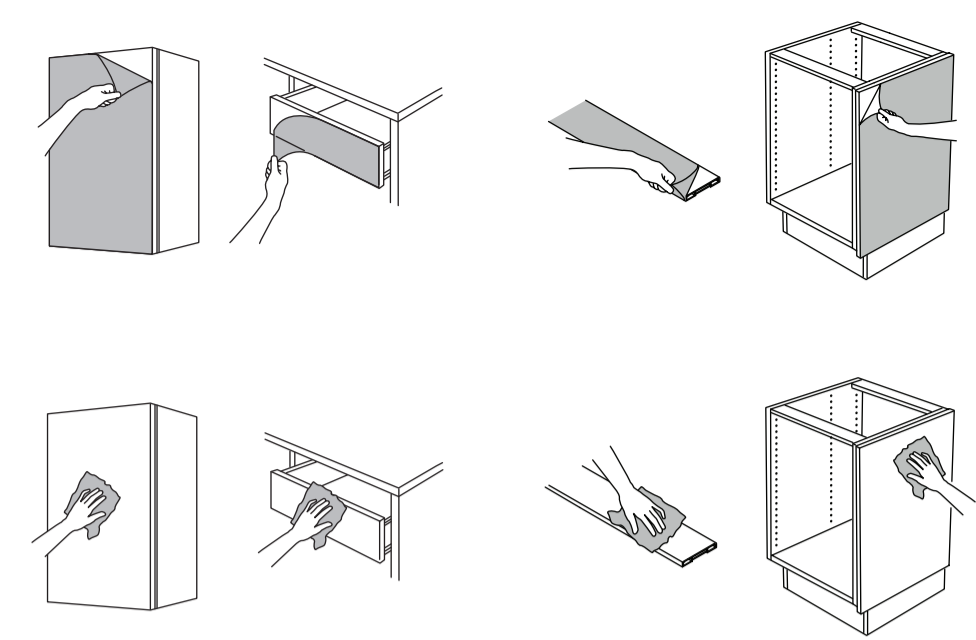

### Româna

Curăța cu o cârpă înmuiată în apă și detergent delicat, neabraziv, sau săpun, dacă este necesar. Șterge cu o cârpă uscată.

**Cum să folosești produse cu folie de protecție**

- Înainte de asamblare, scoate folia de protecție de pe margini și alte suprafețe care pot interfera cu asamblarea.
- Lasă restul foliei de protecție pentru a evita deteriorarea în timpul asamblării. După asamblare, scoate toată folia de protecție.
- Notă - suprafețele pot fi foarte sensibile la zgârieturi imediat după eliminarea foliei de protecție.
- Pentru a îmbunătăți rezistența la zgârieturi, șterge suprafețele cu o soluție de detergent delicat (max. 1%, fără alcool sau substanțe abrazive).



## Srpski

Čisti mekom krpom nakvašenom vodom i blagom neabrazivnom tečnošću za suđe ili sapunom, po potrebi. Osuši čistom krpom.

**Kako da rukuješ proizvodima sa zaštitnom folijom**

- Pre sastavljanja, ukloni foliju s ivica i drugih površina koje mogu uticati na sastavljanje.
- Ostavi preostalu zaštitnu foliju da izbegneš oštećenja tokom sastavljanja. Po sastavljanju, ukloni zaštitnu foliju.
- Napomena — površine mogu biti posebno osetljive na ogrebotine neposredno posle uklanjanja zaštitne folije.
- Da dodatno poboljšaš otpornost na ogrebotine, prebriši površine blagim rastvorom sapuna (maks. 1%, bez alkohola i abraziva).

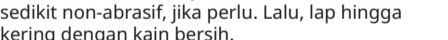
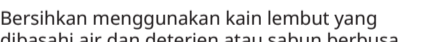
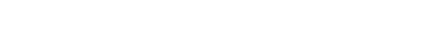

**Bahasa Indonesia**

Bersihkan menggunakan kain lembut yang dibasahi air dan deterjen atau sabun berbusa sedikit non-abrasif, jika perlu. Lalu, lap hingga kering dengan kain bersih.

**Cara melepas film pelindung pada produk Anda**

- Sebelum merakit, lepaskan film pelindung dari tepi dan permukaan lain yang dapat mengganggu perakitan.
- Cabut film pelindung yang tersisa untuk menghindari kerusakan selama perakitan. Setelah perakitan, lepaskan semua film pelindung.
- Catatan - permukaan mungkin sangat sensitif terhadap goresan setelah melepas film pelindung.
- Untuk lebih meningkatkan ketahanan terhadap goresan, lap permukaan dengan larutan sabun ringan (maks. 1%, jangan dengan alkohol atau zat abrasif).

### Slovensky

V prípade potreby utrite mäkkou handričkou namočenou vo vode a jemným neabrazívnym čistiacim prostriedkom na umývanie riadu alebo mydlom. Utrite do sucha čistou handričkou

**Ako zaobchádzať s výrobkami s ochrannou fóliou**

- Pred montážou odstráňte ochranný film z hrán a iných povrchov, ktoré by mohli byť montážou prekryté.
- Zostávajúcu ochrannú fóliu ponechajte, aby sa pri montáži výrobok nepoškodil. Po montáži zvyšok ochrannej fólie odstráňte.
- Pozor, povrchy môžu byť okamžite po odstránení ochrannej fólie mimoriadne citlivé na poškriabanie.
- Aby ste zlepšili ich odolnosť proti poškriabaniu, utrite povrchy jemným mydlovým roztokom (max. 1%, bez alkoholu alebo drsných čističiek).

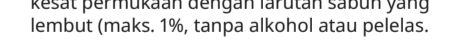
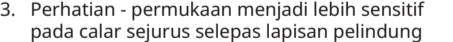
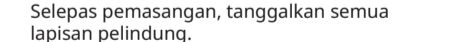
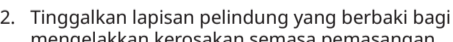
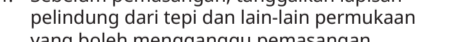
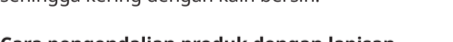
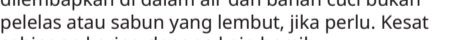
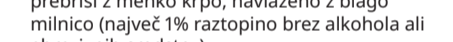
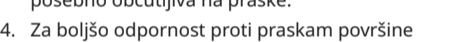
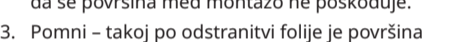
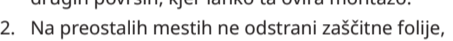
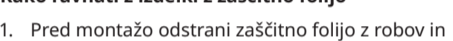
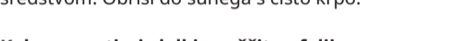
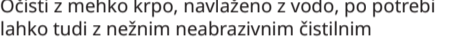

### Български

Ако е необходимо, почистете с кърпа навлажнена с вода и мек неабразивен препарат или сапун. После подсушете с чиста кърпа.

**Работа с продукти покрити с предпазно фолио**

- Преди да започнете сглобяването премахнете предпазното фолио от ъглите и от други повърхност, ако пречат на сглобяването.
- Оставете останалото предпазно фолио с цел защита от щети по време на сглобяването. Премахнете изцяло предпазното фолио след като сте приключили със сглобяването.
- Забележка - след като премахнете предпазното фолио някои повърхности могат да бъдат по-уязвими на надраскване.
- За да направите артикула по-устойчив на надраскване, избършете повърхностите с мек сапунен разтвор (макс. 1%, без алкохол или абразивни елементи).

