

# LAGAN



Design and Quality  
IKEA of Sweden



Please refer to  
**[www.IKEA.com](http://www.IKEA.com)**  
and select your local store for local store phone numbers and opening  
time.

## Contents

Safety information	3	Care and cleaning	11
Safety instructions	6	Troubleshooting	12
Installation	7	Technical information	14
Product description	8	Environmental concerns	15
Operation	9	IKEA guarantee	15
First use	9		
Hints and tips	10		

Subject to change without notice.

## Safety information

Before the installation and use of the appliance, carefully read the supplied instructions. The manufacturer is not responsible if an incorrect installation and use causes injuries and damages. Always keep the instructions with the appliance for future reference.

### **Children and vulnerable people safety**

- This appliance is not intended for use by persons (including children) with reduced physical, sensory or mental capabilities, or lack of experience and knowledge, unless they have been given supervision or instruction concerning use of the appliance by a person responsible for their safety. Children should be supervised to ensure that they do not play with the appliance.
- This appliance may be used by children between 3 and 8 years of age and persons with very extensive and complex disabilities, if they have been properly instructed.
- Children of less than 3 years of age should be kept away unless continuously supervised.
- Do not let children play with the appliance.
- Children shall not carry out cleaning and user maintenance of the appliance without supervision.
- Children aged from 3 to 8 years are allowed to load and unload refrigerating appliances.

- Keep all packaging away from children and dispose of it appropriately.

### **General Safety**

- This appliance is intended to be used in household and similar applications such as:
  - Staff kitchen areas in shops, offices and other working environments;
  - Farmhouses and by clients in hotels, motels and other residential type environments;
  - Bed and breakfast type environments;
  - Catering and similar non-retail applications.
- This type of refrigerator is widely used in places such as hotels, offices, student dormitories and houses. It is mostly suitable for refrigerating and preserving foods such as fruits and beverage. It enjoys the advantages of small size, light weight, low electric consumption and easy use.
- **WARNING:** Keep ventilation openings, in the appliance enclosure or in the built-in structure, clear of obstruction.
- **WARNING:** Do not use mechanical devices or other means to accelerate the defrosting process, other than those recommended by the manufacturer.
- **WARNING:** Do not damage the refrigerant circuit.
- **WARNING:** Do not use electrical appliances inside the food storage compartments of the appliance, unless they are of the type recommended by the manufacturer.
- Do not use water spray and steam to clean the appliance.
- Clean the appliance with a moist soft cloth. Only use neutral detergents. Do not use abrasive products, abrasive cleaning pads, solvents or metal objects.
- Do not store explosive substances such as aerosol cans with a flammable propellant in this appliance.
- If the supply cord is damaged, it must be replaced by the manufacturer, its Authorised Service Centre or similarly qualified persons in order to avoid a hazard.



- **WARNING:** When positioning the appliance, ensure the supply cord is not trapped or damaged.
- **WARNING:** Do not locate multiple portable socket-outlets or portable power supplies at the rear of the appliance.
- Opening the door for long periods can cause a significant increase of the temperature in the compartments of the appliance.
- Clean regularly surfaces that can come in contact with food and accessible drainage systems.
- Clean water tanks if they have not been used for 48 hours; flush the water system connected to a water supply if water has not been drawn for 5 days.
- Store raw meat and fish in suitable containers in the refrigerator, so that it is not in contact with or drip onto other food.
- If the refrigerating appliance is left empty for long periods, switch off, defrost, clean, dry, and leave the door open to prevent mould developing within the appliance.
- Two-star frozen-food compartments are suitable for storing pre-frozen food, storing or making ice-cream and making ice cubes.
- One-, two- and three-star compartments are not suitable for the freezing of fresh food.
- This refrigerating appliance is not suitable for freezing foodstuffs.
- This refrigerating appliance is not intended to be used as a built-in appliance.
- The appliance is equipped with a lamp for interior lighting. Only service is allowed to replace the lighting device. Contact your Authorised Service Centre.
- **WARNING:** To avoid a hazard due to instability of the appliance, it must be fixed in accordance with the instructions.

## Safety instructions

### Installation

-  **Warning!** Only a qualified person can install this appliance.
- Remove all the packaging and the transit bolts.
- Do not install or use a damaged appliance.
- Follow the installation instruction supplied with the appliance.
- Always take care when moving the appliance as it is heavy. Always use safety gloves and enclosed footwear.
- Make sure the air can circulate around the appliance.
- Do not tilt the refrigerator for more than 45° from upright during moving it.
- Wait at least 4 hours before connecting the appliance to the power supply. This is to allow the oil to flow back in the compressor.
- Do not install the appliance close to radiators or cookers, oven or hobs.
- The rear of the appliance must stand against the wall.
- Do not install the appliance where there is direct sunlight.
- Do not install this appliance in areas that are too humid or too colds, such as the construction appendices, garages or wine cellars.
- When you move the appliance, lift it by the front edge to avoid scratching the floor.

### Electrical connection

-  **Warning!** Risk of fire and electrical shock.
-  **Warning!** When positioning the appliance, ensure the supply cord is not trapped or damaged.
-  **Warning!** Do not use multi-plug adapters and extension cables.
- The appliance must be earthed.
- All electrical connections should be made by a qualified electrician.
- Make sure that the parameters on the rating plate are compatible with the electrical ratings of the mains power supply. If not, contact an electrician.
- Always use a correctly installed shockproof socket.

- Make sure not to cause damage to the electrical components (e.g. mains plug, mains cable, compressor). Contact the Authorised Service Centre or an electrician to change the electrical components.
- The mains cable must stay below the level of the mains plug.
- Connect the mains plug to the mains socket only at the end of the installation. Make sure that there is access to the mains plug after the installation.
- Do not pull the mains cable to disconnect the appliance. Always pull the mains plug.

### Use

-  **Warning!** Risk of injury, burns, electrical shock or fire.



The appliance contains flammable gas, isobutane (R600a), a natural gas with a high level of environmental compatibility. Be careful not to cause damage to the refrigerant circuit containing isobutane.

- The surface of the compressor becomes hot: The surface of the compressor may become hot under normal operation. Do not touch it with hands.
- Do not change the specification of this appliance.
- Do not put electrical appliances (e.g. ice cream makers) in the appliance unless they are stated applicable by the manufacturer.
- If damage occurs to the refrigerant circuit, make sure that there are no flames and sources of ignition in the room. Ventilate the room.
- Do not let hot items to touch the plastic parts of the appliance.
- Do not put soft drinks in the frozen-food compartment. This will create pressure on the drink container.
- Do not store flammable gas and liquid in the appliance.
- Do not put flammable products or items that are wet with flammable products in, near or on the appliance.

- Do not touch the compressor or the condenser. They are hot.
- Do not remove or touch items from the frozen-food compartment if your hands are wet or damp.
- Thawed food should not be put back in the frozen-food compartment.
- Follow the storage instructions on the packaging of frozen food.

### Internal lighting

 **Warning!** Risk of electric shock.

- The lamp is only for interior lighting of the appliance. Do not use it for house lighting.

### Care and cleaning

 **Warning!** Risk of injury or damage to the appliance.

- Before maintenance, deactivate the appliance and disconnect the mains plug from the mains socket.
- This appliance contains hydrocarbons in the cooling unit. Only a qualified person can do the maintenance and the recharging of the unit.
- Regularly examine the drain of the appliance and if necessary, clean it. If the drain is blocked, defrosted water collects in the bottom of the appliance.

### Disposal

 **Warning!** Risk of injury or suffocation.

- Disconnect the appliance from the mains supply.
- Cut off the mains cable and discard it.
- Remove the door to prevent children and pets to be closed inside of the appliance.
- The refrigerant circuit and the insulation materials of this appliance are ozone-friendly.
- The insulation foam contains flammable gas. Contact your municipal authority for information on how to discard the appliance correctly.
- Do not cause damage to the part of the cooling unit that is near the heat exchanger.

## Installation

 **Warning!** Refer to Safety chapters.

### Positioning

- Follow the separate Assembly Instructions to install this appliance.
- Do not install it in high temperature of humidity. Place so as to avoid being damaged, dampened and rusted.
- This appliance should be installed in a dry, well ventilated indoor where the ambient temperature corresponds to the climate class indicated on the rating plate of the appliance:

Climate class	Ambient temperature
SN	+10°C to +32°C
N	+16°C to +32°C
ST	+16°C to +38°C
T	+16°C to +43°C

- "SN" indicates that this refrigerating appliance is intended to be used at ambient temperatures ranging from 10 °C to 32 °C.
- "N" indicates that this refrigerating appliance is intended to be used at ambient temperatures ranging from 16 °C to 32 °C.
- "ST" indicates that this refrigerating appliance is intended to be used at ambient temperatures ranging from 16 °C to 38 °C.
- "T" indicates that this refrigerating appliance is intended to be used at ambient temperatures ranging from 16 °C to 43 °C.

 Some functional problems might occur for some types of models when operating outside of that range. The correct operation can only be guaranteed within the specified temperature range.  
If you have any doubts regarding installation, please turn to the vendor, to our customer service or to the nearest Authorised Service Centre.

**Location**

- To ensure best performance, install the appliance well away from sources of heat such as radiators, boilers, direct sunlight etc. Make sure that air can circulate freely around the back of the cabinet.

**⚠ Caution!** In order to guarantee proper functioning in ambient temperature above 38°C, it is advised to have a 30mm separation between the sides of the appliance and surrounding furniture.

**Electrical connection**

**⚠ Caution!** DO NOT REMOVE GROUND PRONG. DO NOT USE AN ADAPTOR. DO NOT USE EXTENSION CORD. Failure to follow these instructions can result in death, fire or electrical shock.

Before plugging in, ensure that the voltage and frequency shown on the rating plate correspond to your domestic power supply.

The appliance must be earthed. The power supply cable plug is provided with a contact for this purpose. If the domestic power supply socket is not earthed, connect the appliance to a separate earth in compliance with current regulations, consulting a qualified electrician.

The manufacture declines all responsibility if the above safety precautions are not observed.

## Product description

Carefully read the operating instructions before using the appliance.

- 1** Storage shelves
- 2** Three-star compartment
- 3** Temperature regulator and interior lighting
- 4** Variable storage box
- 5** Fruit and vegetable drawer
- 6** Rating plate

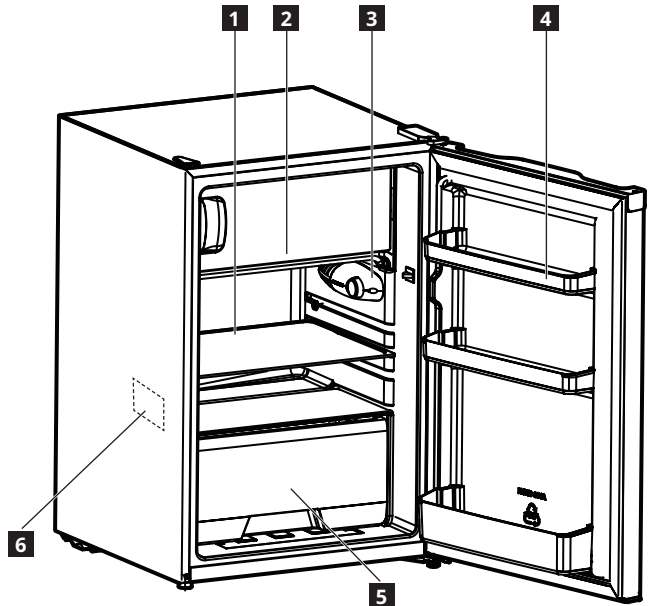

## Operation

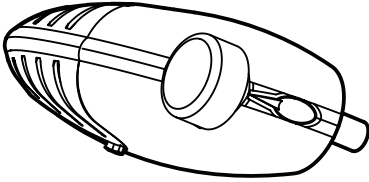

### Switching on

Connect the mains plug to the power socket.

Set the temperature regulator to a medium setting (Refer to "Temperature regulation").

When operating the appliance for the first time, set the appliance at a colder temperature and run it without loading any food until it auto stops at the set temperature. Usually it takes 2 or 3 hours, then set the temperature regulator at the desired setting and put food in the appliance.

### Switching off

To turn off the appliance, turn the temperature regulator to the "OFF" position.

Give the appliance time to cool down completely before adding food. It is best to wait 24 hours before adding food

## First use

### Cleaning the interior

Before using the appliance for the first time, wash the interior and all internal accessories with lukewarm water and some neutral soap so as to remove the typical smell of a brand new product, then dry thoroughly.

### Temperature regulation

The temperature is automatically regulated. To operate the appliance, proceed as follows:

- Turn the temperature regulator toward lower settings to obtain the minimum coldness.
- Turn the temperature regulator toward higher settings to obtain the maximum coldness.

**i** A medium setting is generally the most suitable.

Adjust the temperature setting by keeping in mind that the temperature inside the appliance depends on:

- room temperature
- how often the door is opened
- the quantity of food stored
- the location of the appliance

**Important!** If the ambient temperature is high or the appliance is fully loaded, and the appliance is set to the lowest temperatures, it may run continuously causing frost to form on the rear wall. In this case a higher temperature must be set to allow automatic defrosting and therefore reduced energy consumption.

**Important!** Do not use detergents or abrasive powders, as these will damage the finish.

## Hints and tips

### Normal operating sounds

The following sounds are normal during operation:

- A faint gurgling and bubbling sound from coils sound when refrigerant is pumped.
- A whirring and pulsating sound from the compressor when refrigerant is pumped.
- A sudden cracking noise from inside appliance caused by thermic dilatation (a natural and not dangerous physical phenomenon).

### Hints for energy saving

- Do not open the door frequently or leave it open longer than absolutely necessary.
- If the ambient temperature is high and very low internal temperature is set and the appliance is fully loaded, the compressor may run continuously, causing frost or ice on the evaporator. If this happens, set the internal temperature toward warmer one to allow automatic defrosting and so a saving in electricity consumption.

### Hints for fresh food refrigeration

- Do not store warm food or evaporating liquids in the refrigerator.
- Cover or wrap the food, particularly if it has a strong flavour.
- Position food so that air can circulate freely around it.

### Hints for refrigeration

Useful hints:

- Meat (all types): wrap in a suitable packaging and place it on the glass shelf above the vegetable drawer. Store meat for at most 1-2 days.
- Cooked foods, cold dishes: cover and place on any shelf.
- Fruit and vegetables: clean thoroughly and place in a special drawer. Bananas, potatoes, onions and garlic must not be kept in the refrigerator if not packed.
- Butter and cheese: place in a special airtight container or wrap in an aluminium foil or a polythene bag to exclude as much air as possible.
- Bottles: close with a cap and place on the door bottle shelf, or (if available) on the bottle rack.

### Cautions for Use

- The more food stuff put in or the more and the longer for once the door is opened, the more it needs electric consumption, which even leads malfunction.
- Re-plug in the power plug at the interval of over ten minutes.
- Do not store bottled drink in the frozen-food compartment, so as to prevent from being broken and damaging the refrigerator.
- Open the door as less as possible during power-cut.
- When defrosting, never use any sharp or metallic objects to remove the frost on the surface of the evaporator as it will damage the evaporator.
- Do not touch foods and containers in the frozen-food compartment with your wet hands so as to prevent from being frostbitten.

### Storage of frozen food

- When first starting-up or after a period out of use, before putting the products in the compartment let the appliance run at least 2 hours on the colder setting.
- When you close and seal the package you must not allow air or moisture in or out. If you do, you could have food odour and taste transfer throughout the refrigerator, and also dry out frozen food.
- **Note:** Never put bottled food or drinks in the frozen-food compartment.
- For best performance, leave enough space in the frozen-food compartment for air to circulate around the packages. Also let enough room at the front so the door can close tightly.

### Hints for storage of frozen food

To obtain the best performance from this appliance, you should:

- Make sure that the commercially frozen foodstuffs were adequately stored by the retailer.
- Make sure that frozen foodstuffs are transferred from the food store to the frozen-food compartment in the shortest possible time.
- Do not open the door frequently or leave it open longer than absolutely necessary.

- Once defrosted, food deteriorates rapidly and cannot be refrozen.
- Do not exceed the storage period indicated by the food manufacturer.

**⚠ Warning!** In the event of accidental defrosting, for example due to a power failure, if the power has been off for longer than the value shown in the technical characteristics chart under “rising time”, the defrosted food must be consumed quickly.

### Thawing

Deep-frozen or frozen food, prior to being used, can be thawed in the refrigerator compartment or at room temperature, depending on the time available for this operation.

Small pieces may even be cooked still frozen, directly from the frozen-food compartment: in this case, cooking will take longer.

## Care and cleaning

**⚠ Warning!** Refer to Safety chapters.

### General warnings

- ⚠ Caution!** Unplug the appliance before carrying out any maintenance operation.
- i** This appliance contains hydrocarbons in its cooling unit; maintenance and recharging must therefore only be carried out by authorized technicians.
- i** The accessories and parts of the appliance are not suitable for washing in a dishwasher.

### Cleaning the interior

Before using the appliance for the first time, the interior and all internal accessories should be washed with lukewarm water and some neutral soap to remove the typical smell of a brand-new product, then dried thoroughly.

**⚠ Caution!** Do not use detergents or abrasive powders, as these will damage the finish.

### Cleaning the fridge/freezer exterior

Clean the fridge/freezer door exterior using a non-abrasive cloth damped in warm water and mild soap or a cleaning detergent specifically designed for the appliance.

### Initial power on

**⚠ Caution!** Before inserting the power plug in to the outlet and switching on the cabinet for the first time, leave the appliance standing upright for at least 4 hours. This will assure a sufficient amount of time for the oil to return to the compressor. Otherwise the compressor or electronic components may sustain damage.

### Periodic cleaning

- ⚠ Caution!** Do not pull, move or damage any pipes and/or cables inside the cabinet.
- ⚠ Caution!** Do not damage the cooling system.
- ⚠ Caution!** When moving the cabinet, lift it by the front edge to avoid scratching the floor.

The equipment has to be cleaned regularly:

1. Clean the inside and accessories with lukewarm water and some neutral soap.
2. Regularly check the door seals and wipe clean to ensure they are clean and free from debris.
3. Rinse and dry thoroughly.
4. If accessible, clean the condenser and the compressor at the back of the appliance with a brush. This operation will improve the performance of the appliance and save electricity consumption.

### Periods of non-operation

When the appliance is not in use for long periods, take the following precautions:

1. Disconnect the appliance from electricity supply.
2. Remove all food.
3. Defrost (if necessary) and clean the appliance and all accessories.
4. Clean the appliance and all accessories.
5. Leave the door/doors open to prevent unpleasant smells.

**⚠ Caution!** If you want to keep the appliance switched on, ask somebody to check it once in a while to prevent the food inside from spoiling in case of a power failure.

### Defrosting fridge compartment

Defrosting process is automatic: the melted frost in the back of the inside flows into the drip tray on the outside and will automatically evaporate.

### Defrosting frozen-food compartment

Due to seasonal changes, a thick layer of frost may form. To defrost manually, observe the followings.

- Turn the thermostat knob to set at OFF position and leave open the frozen-food compartment door.
- Remove all foods, ice cube tray and shelf or transfer to refrigerator compartment.
- Clean and wipe out the melted frost with a cloth.
- After defrosting, turn thermostat knob to origin position.

 **Caution!** To avoid damaging the frozen-food compartment wall, do not use any sharp objects to remove the frost or separate the frozen food.

## Troubleshooting

 **Warning!** Refer to Safety chapters.

### What to do if...

Problem	Possible Cause	Solution
The appliance does not operate.	The appliance is switched off.	Switch on the appliance.
	The mains plug is not connected to the mains socket correctly.	Connect the mains plug to the mains socket correctly.
	The appliance has no power. There is no voltage in the mains socket.	Connect a different electrical appliance to the mains socket. Contact a qualified electrician.
The appliance is noisy.	The appliance is not supported properly.	Check if the appliance stands stable.
The lamp does not work.	The lamp is defective.	Contact the nearest IKEA store.
The compressor operates continually.	Temperature is set incorrectly.	Refer to "Operation" chapter.
	Many food products were inserted at the same time.	Insert less food products at the same time.
	The room temperature is too high.	Refer to climate class chart on the rating plate.
	Food products placed in the appliance were too warm.	Allow food products to cool to room temperature before storing.
	The door is not closed correctly.	Refer to "Closing the door".

Problem	Possible Cause	Solution
The temperature in the appliance is too low/too high.	The temperature is not set correctly.	Set a higher/lower temperature.
	The door is not closed correctly.	Refer to "Closing the door".
	The food products temperature is too high.	Let the food products temperature decrease to room temperature before storage.
	Many food products are inserted at the same time.	Wait some hours and then check the temperature again.
	The thickness of the frost is greater than 4-5 mm.	Defrost the appliance.
	The door has been opened often.	Open the door only if necessary.
	There is no cold air circulation in the appliance.	Make sure that there is cold air circulation in the appliance.
Food in the refrigerator compartment is freezing.	The thermostat knob is set too cold.	Turn the thermostat knob to a lower setting (higher temperature).
	The position of food stored touches the refrigerant power of the refrigerator back wall.	Move food away from the back wall.
Food in the refrigerator compartment is not cold.	The air vents are blocked in the compartment. This prevents the movement of cold air.	Make sure air can circulate inside.
	The door(s) are opened too often or not close properly.	Avoid frequent openings of the fridge door.
	A large amount of food has just been added to the refrigerator or refrigerator compartment.	Load with less amount food at the time.
	The position of thermostat knob is adjusted too low.	Turn the thermostat knob to a higher setting (lower temperature).
Melted frost leak over compartment inside or floor.	The drain - off mouth entrance is blocked.	Use the cleaning spout to clear blockage.
There is interior moisture build - up.	The air vents are blocked in the refrigerator.	Make sure air can circulate inside.
	The door is opened often.	Avoid frequent openings of the fridge door.
	The food is not packaged correctly.	Make sure foods are packed correctly.
	The temperature is not set correctly of the surrounding conditions.	Turn the thermostat knob to a higher setting (lower temperature).
The door does not close completely.	The shelves are out of position.	Make sure the shelves are in correct position.
	The door gaskets are dirty.	Clean the door gaskets.
	The appliance is not level.	Make sure the appliances is installed in level.

- i** If your appliance still is not working properly after making the above checks, contact the nearest IKEA store.

**Closing the door**

1. Clean the door gaskets.
2. If necessary, adjust the door. Refer to the separate Assembly Instructions.
3. If necessary, replace the defective door gaskets. Contact the After Sales Service.

**Replacing the lamp**

The appliance is equipped with a lamp for interior lighting.

Only service is allowed to replace the lighting device.

**Technical information**

<b>Product category</b>	
Product type	Refrigerator
Installation type	Freestanding
<b>Product dimensions</b>	
Height	832 mm
Width	550 mm
Depth	570 mm
<b>Net volume</b>	
Fridge	97 L
Three-star compartment	16 L
<b>Defrost system</b>	
Fridge	Manual
Three-star compartment	Manual
Star rating	***
Energy consumption	18.6 kWh/m
Energy class	1 Star
Voltage	220 - 240 V
Frequency	60 Hz

- i** The article number and the serial number are situated in the rating plate on the internal left side of the appliance.

Article Number  
(8-digit code)

Serial Number  
(start with SN,  
22-digit code)

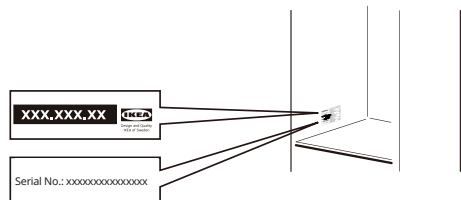

Picture for reference only

## Environmental concerns

Recycle materials with the symbol . Put the packaging in relevant containers to recycle it.

Help protect the environment and human health by recycling waste of electrical and electronic appliances. Do not dispose of this product with the household waste. Return the product to your local recycling facility or contact your municipal office.

## IKEA guarantee

### How long is the IKEA guarantee valid?

This guarantee is valid for **five (5) years** from the original date of purchase of your appliance at IKEA. The original sales receipt is required as proof of purchase. If service work is carried out under guarantee, it will not extend the guarantee period for the appliance. Which LAGAN appliances are not covered by the IKEA 5-year guarantee? LAGAN appliances purchased from IKEA before 1 May 2026 are covered by a 2-year guarantee, starting from the original date of purchase.

### Who will execute the service?

IKEA service provider will provide the service through its own service operations or authorized service partner network.

### What does this guarantee cover?

The guarantee covers faults of the appliance, which have been caused by faulty construction or material faults from the date of purchase from IKEA. This guarantee applies to domestic use only. The exceptions are specified under the headline "What is not covered under this guarantee?" Within the guarantee period, the costs to remedy the fault e.g. repairs, parts, labour and travel will be covered, provided that the appliance is accessible for repair without special expenditure. On these conditions the respective local regulations are applicable. Replaced parts become the property of IKEA.

### What will IKEA do to correct the problem?

IKEA appointed Service Provider will examine the product and decide, at its sole discretion, if it is covered under this guarantee. If considered covered, IKEA Service Provider or its authorized service partner through its own service operations, will then, at its sole discretion, either repair the defective product or replace it with the same or a comparable product.

### What is not covered under this guarantee?

- Normal wear and tear.

- Deliberate or negligent damage, damage caused by failure to observe operating instructions, incorrect installation or by connection to the wrong voltage, damage caused by chemical or electro-chemical reaction, rust, corrosion or water damage including but not limited to damage caused by excessive lime in the water supply, damage caused by abnormal environmental conditions.
- Consumable parts including batteries and lamps.
- Non-functional and decorative parts which do not affect normal use of the appliance, including any scratches and possible colour differences.
- Accidental damage caused by foreign objects or substances and cleaning or unblocking of filters, drainage systems or soap drawers.
- Damage to the following parts: ceramic glass, accessories, crockery and cutlery baskets, feed and drainage pipes, seals, lamps and lamp covers, screens, knobs, casings and parts of casings. Unless such damages can be proved to have been caused by production faults.
- Cases where no fault could be found during a technician's visit.
- Repairs not carried out by our appointed service providers and/or an authorized service contractual partner or where non-original parts have been used.
- Repairs caused by installation which is faulty or not according to specification.
- The use of the appliance in a non-domestic environment i.e. professional use.
- Transportation damages. If a customer transports the product to his home or another address, IKEA is not liable for any damage that may occur during transport. However, if IKEA delivers the product to the customer's delivery

address, then damage to the product that occurs during this delivery will be covered by IKEA.

- Cost for carrying out the initial installation of the IKEA appliance.
- However, if an IKEA appointed Service Provider or its authorized service partner repairs or replaces the appliance under the terms of this guarantee, the appointed Service Provider or its authorized service partner will reinstall the repaired appliance or install the replacement, if necessary.
- All plumbing and electrical installation, are not the responsibility of IKEA, and customer must complete these work before the execution work.

### How country law applies

The IKEA warranty gives you specific legal rights, which cover or exceed all the local legal demands. However these conditions do not limit in any way consumer rights described in the local legislation.

### Area of validity

This warranty is valid only in the country where the product has been purchased; the services will be provided in the framework of the guarantee conditions. An obligation to carry out services in the framework of the guarantee exists only if the appliance complies and is installed in accordance with:

- the technical specifications of the country in which the guarantee claim is made;
- the Assembly Instructions and User Manual Safety Information;

### The dedicated AFTER SALES for IKEA appliances

Please don't hesitate to contact IKEA appointed Authorized Service Centre to:

- make a service request under this guarantee;
- ask for clarifications on installation of the IKEA appliance in the dedicated IKEA kitchen furniture;
- ask for clarification on functions of IKEA appliances.

To ensure that we provide you with the best assistance, please read carefully the Assembly Instructions and/or the User Manual before contacting us.

### How to reach us if you need our service



The IKEA after sales customer service center will assist you on the phone with basic troubleshooting for your appliances at the time of service call request.

Please refer to [www.IKEA.com](http://www.IKEA.com) and select your local store for local store phone numbers and opening times.

Before calling us, assure that You have to hand the IKEA article number (8 digit code) and the Serial Number (8 digit code that can be found on the rating plate) for the appliance of which you need our assistance.

- i** **SAVE THE SALES RECEIPT!** It is your proof of purchase and required for the guarantee to apply. Note that the receipt reports also the IKEA article name and number (8 digit code) for each of the appliances you have purchased.

### Do you need extra help?

For any additional questions not related to After Sales of your appliances please contact your nearest IKEA store call centre. We recommend you read the appliance documentation carefully before contacting us.







