

MARKFROST

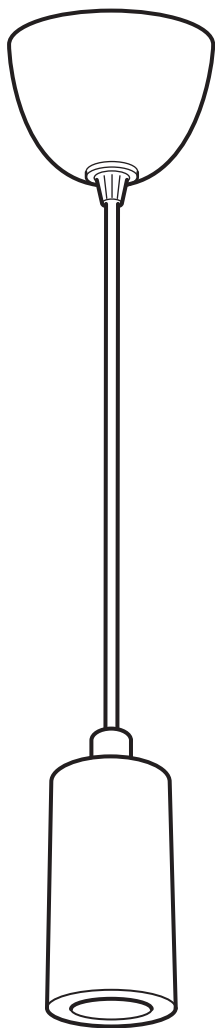

Design and Quality
IKEA of Sweden



ENGLISH
INSTALLATION INSTRUCTIONS

CAUTION:

Before starting, turn off power at main circuit panel.

FRANÇAIS
INSTRUCTIONS D'INSTALLATION

ATTENTION:

coupez l'alimentation avant de procéder à l'installation.

ESPAÑOL
INSTRUCCIONES DE MONTAJE

ADVERTENCIA:

Antes de comenzar el montaje, cortar la luz en el cuadro general.

MX

Importador/Distribuidor: IKEA Supply Mexico, S.A. de C.V., Av. Paseo de las Palmas 275, Int. 403-404, Lomas de Chapultepec V sección, Miguel Hidalgo C.P.: 11000 Ciudad de México, México, Tel. 800-1-4532 69.

Lea y siga todas las instrucciones de seguridad y operación antes de usar este producto/Para uso Interior/Consulte Especificaciones eléctricas en el etiquetado del producto.

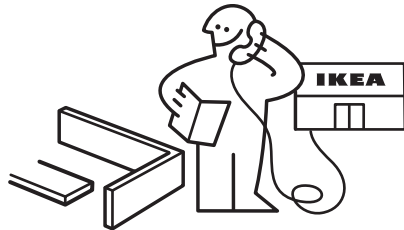
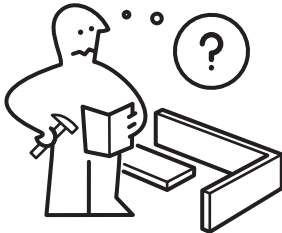

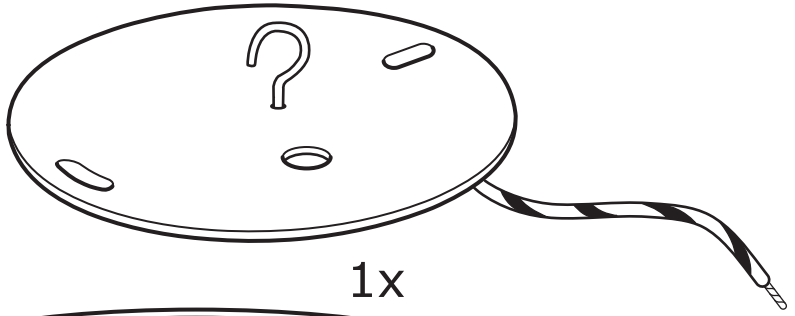

1x

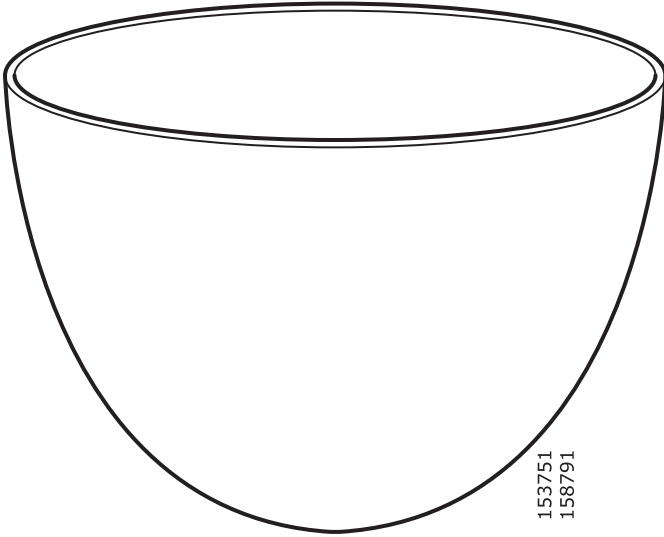

153751
158791

1x

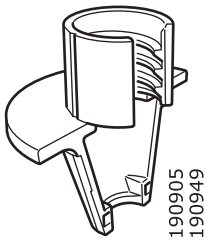

190905
190949

1x

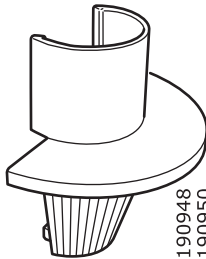

190948
190950

1x

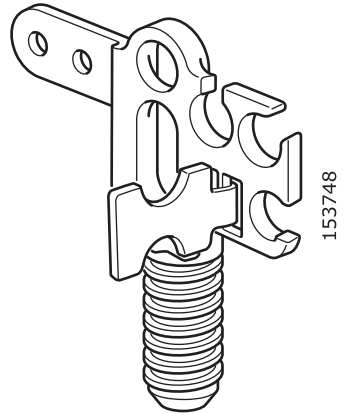

153748

1x

1

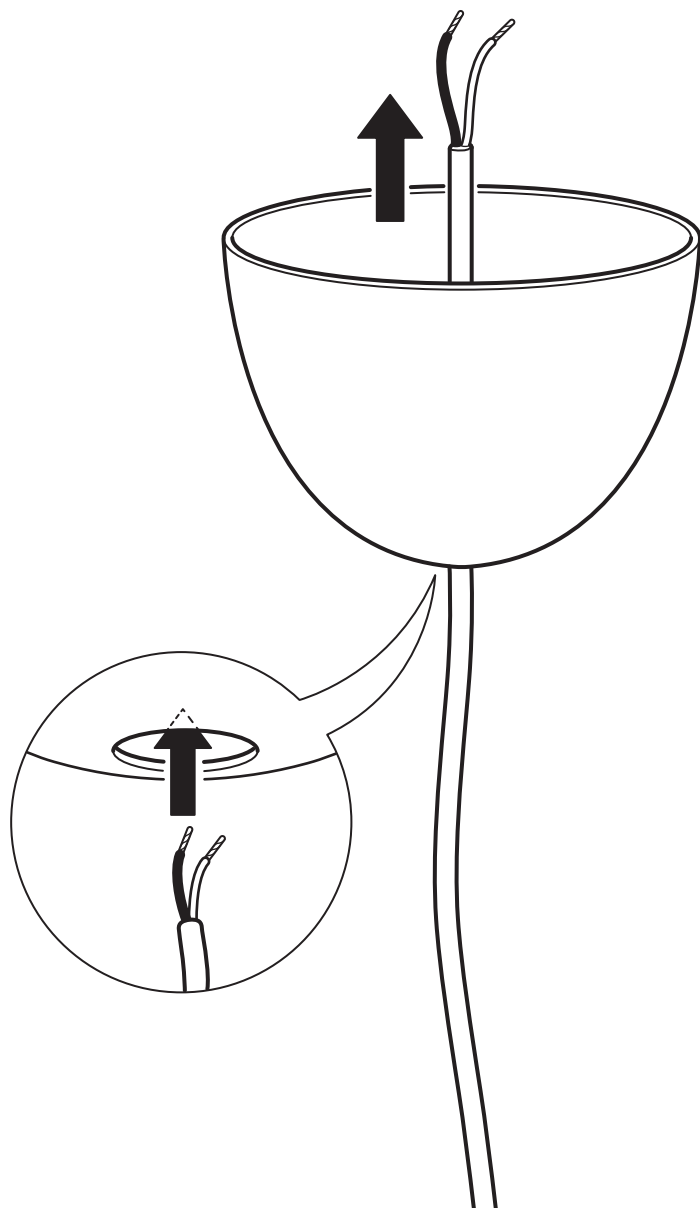

2

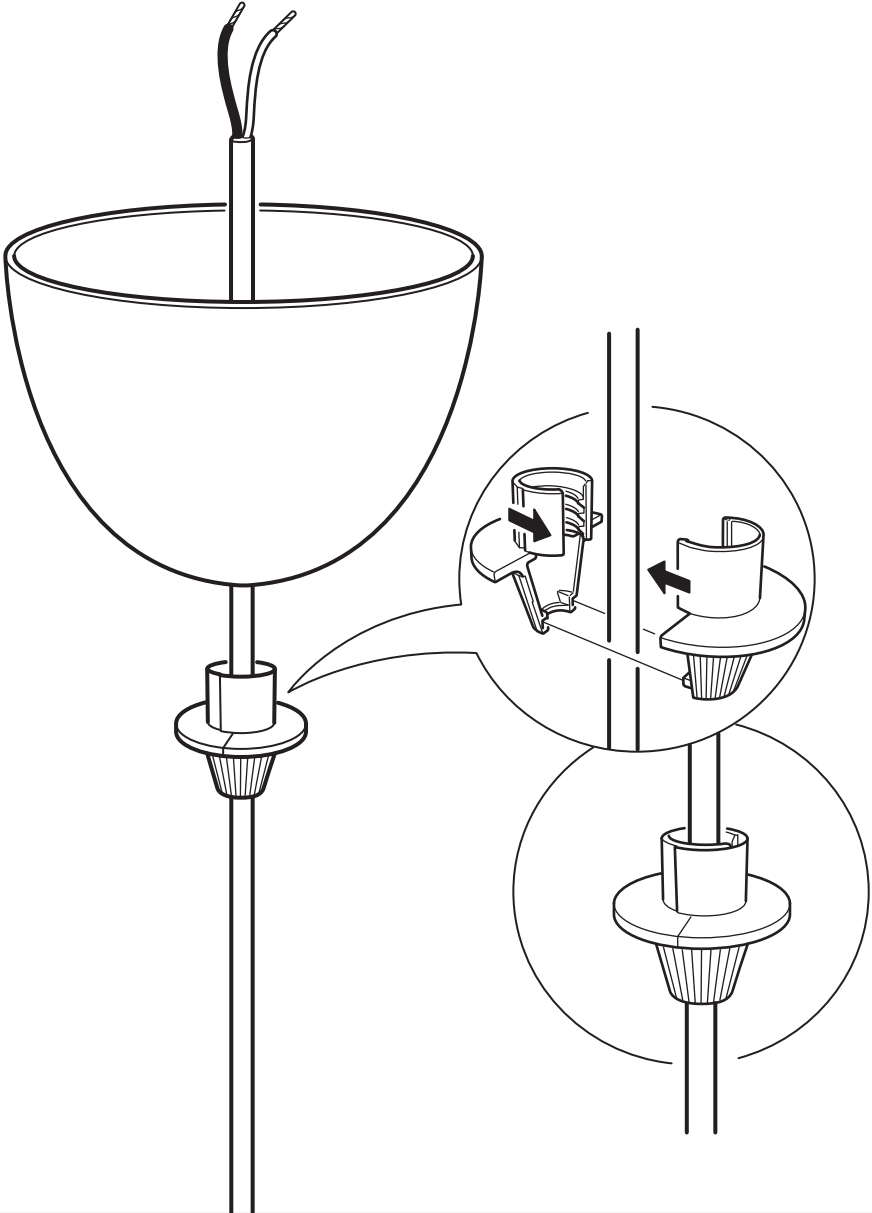

4

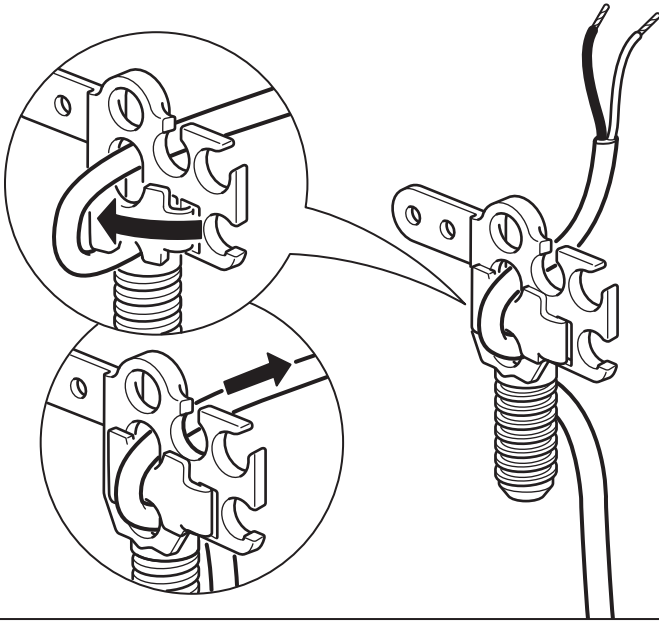

5

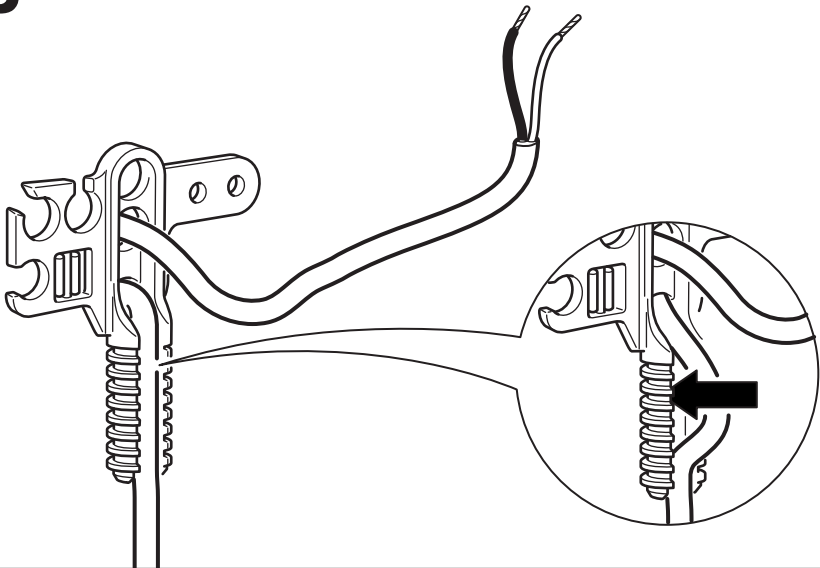

6

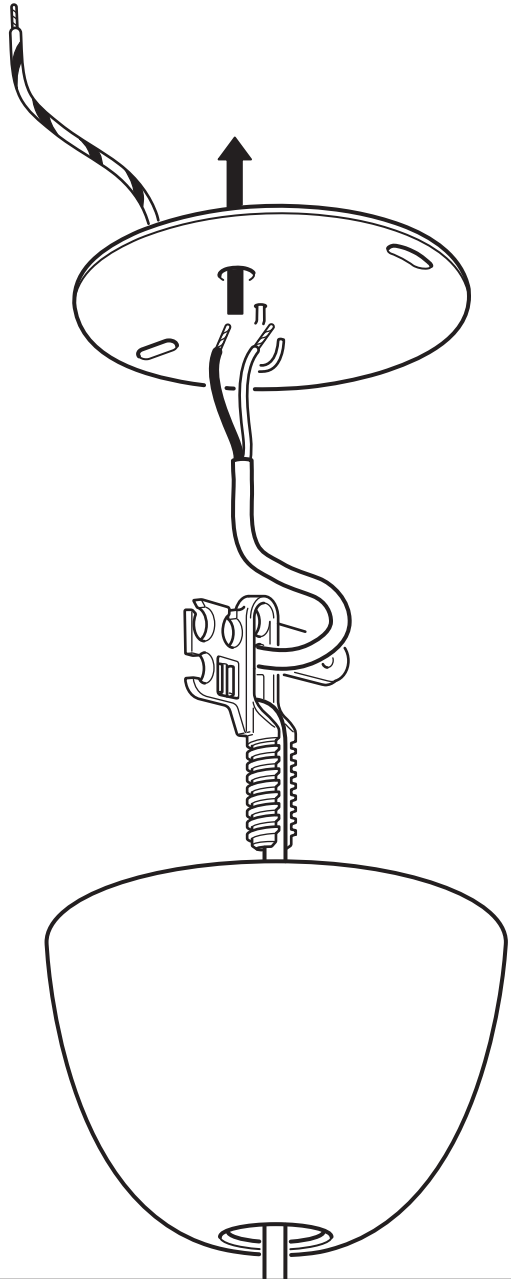

7



ENGLISH
Live

FRANÇAIS
Phase

ESPAÑOL
Con corriente

ENGLISH
Neutral

FRANÇAIS
Neutre

ESPAÑOL
Neutro

ENGLISH
Earth/
Ground

FRANÇAIS
Terre

ESPAÑOL
Tierra

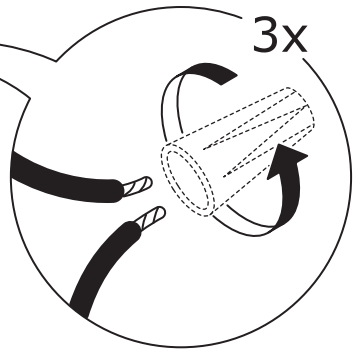
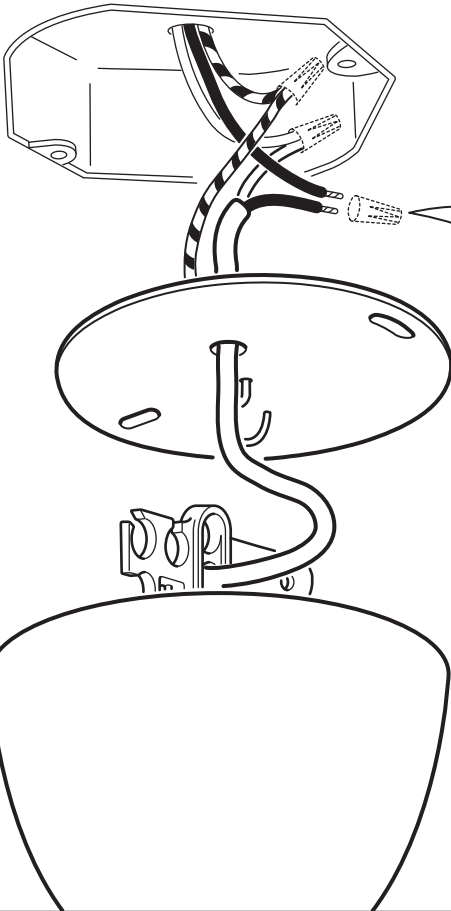

8

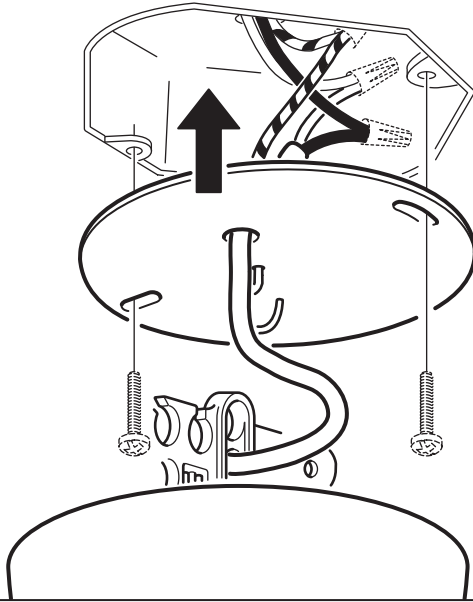

9

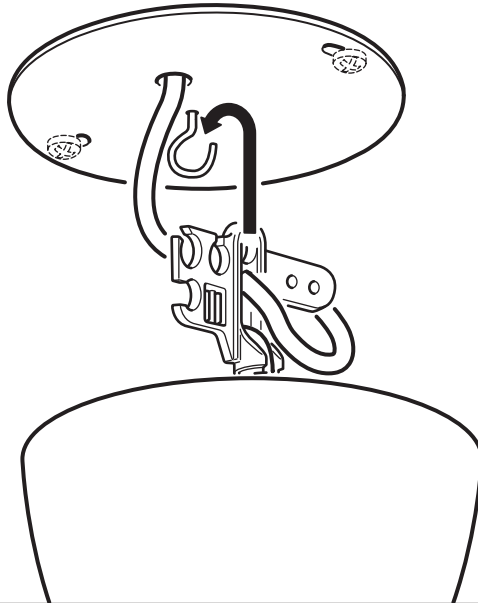

10

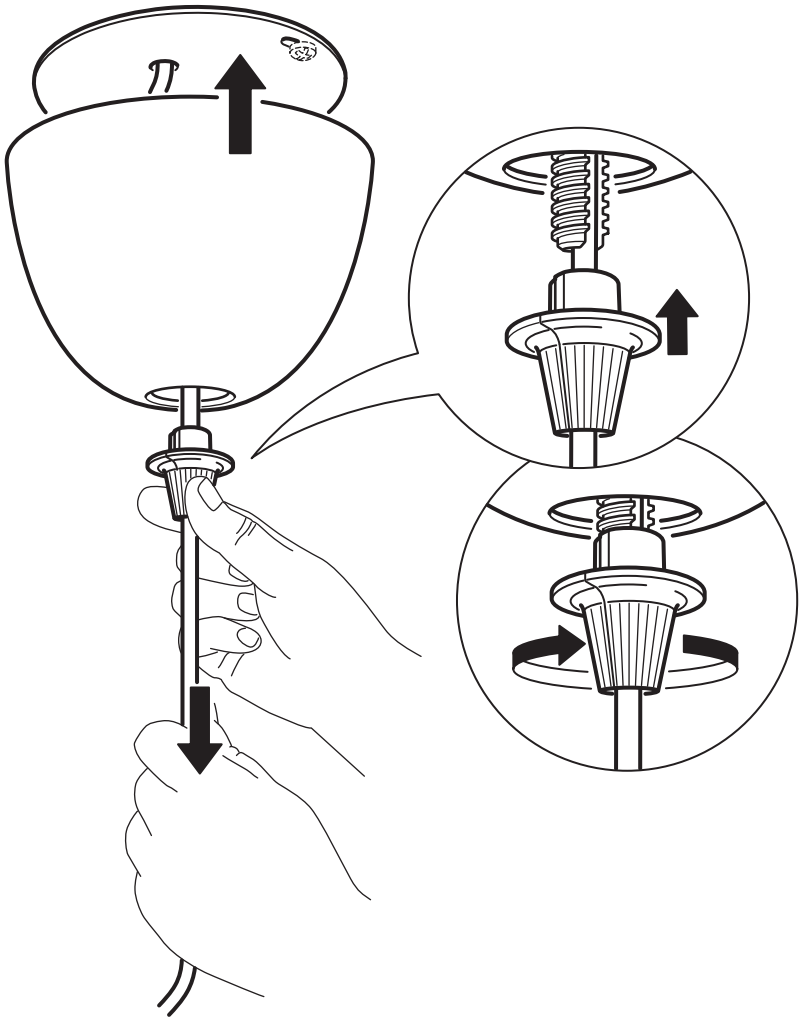

ENGLISH
CAUTION!
Do not overtighten.

FRANÇAIS
ATTENTION!
Ne pas trop serrer.

ESPAÑOL
¡PRECAUCIÓN!
No apretar en exceso.

