

LIXHULT

Storage cabinets

CARE

Wipe clean with a cloth dampened in a mild cleaner. Wipe dry with a clean cloth.

SAFETY

Secure It! Prevent tip-over injury. Furniture with included restraints must be secured to the wall according to the assembly instructions.

Different wall materials require different types of fixing devices. Use fixing devices suitable for the walls in your home (not included).

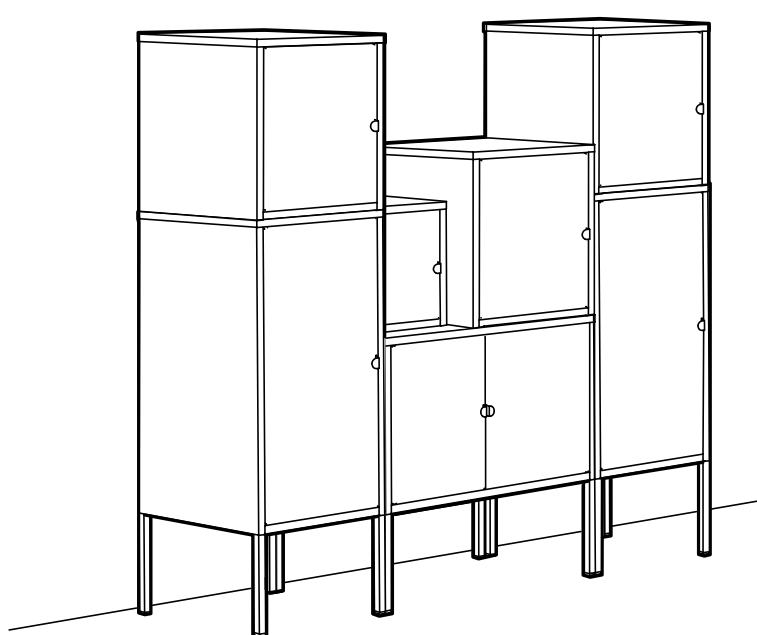

Expressive storage your way!

Whether you prefer a toned down minimalistic or playful and colorful expression, the LIXHULT cabinets are a storage solution that fits across the home. The series is perfect to use in those spaces where you normally cannot fit larger storage units; in between furniture, in corners, between windows and under staircases. Basically, anywhere you need and want it!

You can use LIXHULT as a small and fun solution, or as larger, personalized combinations. Make your own LIXHULT by combining the different sizes and colors, have fun and let your personality shine through!

A high standard of accuracy has been sought in the preparation of this buying guide. We apologize for, but will not be bound by or responsible for, errors and omissions in this buying guide.

Not all products may be available in all stores. See what is available at your local store by visiting IKEA-USA.com/stockavailability. For more detailed product information, see the price tag or visit IKEA-USA.com. All products shown require assembly. All textiles shown are imported.



WALL ANCHORING GUIDE

If your wall material is not listed or if you have questions, consult with a local hardware retailer.

We all want our homes to be a safe place. But in our homes, accidents can put children at risk. Working together, we can help prevent these accidents and make the home a safer place.

- Secure it! Use the right hardware for your wall type. Consult

the enclosed guide for help with hardware.

- Never put a TV or other heavy objects on top of LIXHULT that is not intended for use with a TV.
- Never let children climb or hang on doors or shelves.

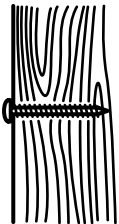

Wall Material: Drywall or plaster with available wood stud.

Anchoring device: Screw inserted directly into stud. For example, a 5 mm wood screw provided with IKEA FIXA plug and screw set.

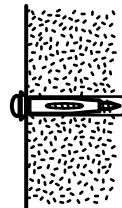

Wall Material: Masonry.

Anchoring device: Plug with screw. For example, an 8 mm plug provided with IKEA FIXA plug and screw set.

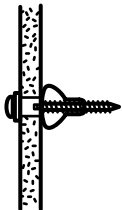

Wall Material: Drywall or plaster without available wood stud.

Anchoring device: Plug with screw. For example, an 8 mm plug provided with IKEA FIXA plug and screw set.

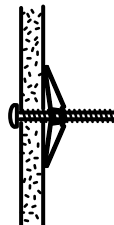

Anchoring device hollow wall: Toggle-style.

COMBINATIONS

You can combine different colors and sizes, change the placement of the cabinets as you like and create a solution with its own complete look. Here are some suggestions.

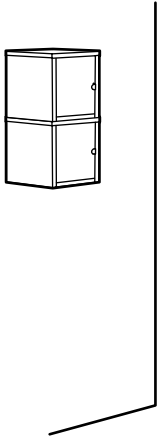

LIXHULT Wall-mounted storage combination
Total size: W9 $\frac{7}{8}$ ×D9 $\frac{7}{8}$ ×H19 $\frac{5}{8}$ ".

This combination \$30

White	891.615.08
White/pink	992.486.53

Articles for this combination

LIXHULT Cabinet 9 $\frac{7}{8}$ ×9 $\frac{7}{8}$ ".	White or pink	2 pcs
---	---------------	-------

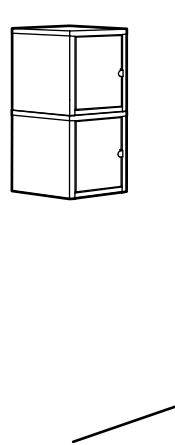

LIXHULT Wall-mounted storage combination
Total size: W13 $\frac{3}{4}$ ×D13 $\frac{3}{4}$ ×H27 $\frac{1}{2}$ ".

This combination \$50

Orange/orange	291.615.92
Dark green/orange	292.486.56

Articles for this combination

LIXHULT Cabinet 13 $\frac{3}{4}$ ×13 $\frac{3}{4}$ ".	Dark green or orange	2 pcs
---	----------------------	-------

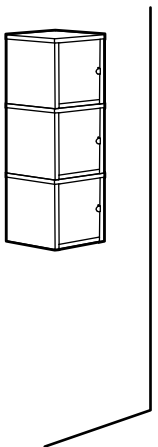

LIXHULT Wall-mounted storage combination
Total size: W9 $\frac{7}{8}$ ×D9 $\frac{7}{8}$ ×H29 $\frac{1}{2}$ ".

This combination \$45

White/pink	692.486.59
------------	------------

Articles for this combination

LIXHULT Cabinet 9 $\frac{7}{8}$ ×9 $\frac{7}{8}$ ".	White or pink	3 pcs
---	---------------	-------

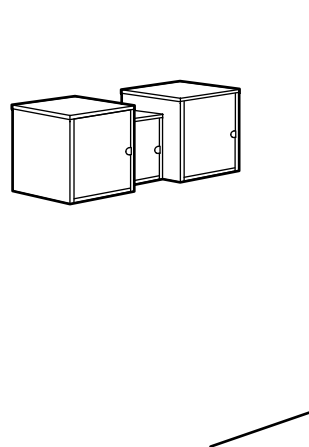

LIXHULT Wall-mounted storage combination
Total size: W37 $\frac{3}{8}$ ×D13 $\frac{3}{4}$ ×H13 $\frac{3}{4}$ ".

This combination \$65

Orange/white	991.615.98
--------------	------------

Articles for this combination

LIXHULT Cabinet 13 $\frac{3}{4}$ ×13 $\frac{3}{4}$ ".	Dark green or orange	2 pcs
LIXHULT Cabinet 9 $\frac{7}{8}$ ×9 $\frac{7}{8}$ ".	White or pink	1 pc

COMBINATIONS

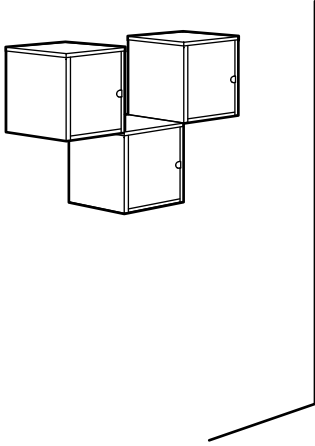

LIXHULT Wall-mounted storage combination

Total size: W41 $\frac{3}{8}$ "x D13 $\frac{3}{4}$ "x H27 $\frac{1}{2}$ ".

This combination \$75

Orange/dark green

792.486.68

Articles for this combination

LIXHULT Cabinet 13 $\frac{3}{4}$ "x13 $\frac{3}{4}$ ".

Dark green or orange 3 pcs

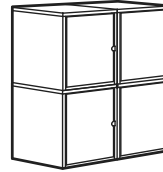

LIXHULT Wall-mounted storage combination

Total size: W19 $\frac{5}{8}$ "x D9 $\frac{7}{8}$ "x H19 $\frac{5}{8}$ ".

This combination \$60

White

892.791.74

Articles for this combination

LIXHULT Cabinet 9 $\frac{7}{8}$ "x9 $\frac{7}{8}$ ".

White or pink 4 pcs

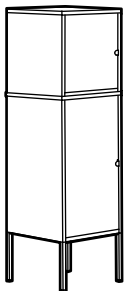

LIXHULT Floor-based storage combination

Total size: W13 $\frac{3}{4}$ "x D13 $\frac{3}{4}$ "x H46 $\frac{1}{8}$ ".

This combination \$65

Red/orange

491.616.09

Articles for this combination

LIXHULT Cabinet 13 $\frac{3}{4}$ "x13 $\frac{3}{4}$ ".

Dark green or orange 1 pc

LIXHULT Cabinet 13 $\frac{3}{4}$ "x23 $\frac{3}{8}$ ".

Red or dark blue 1 pc

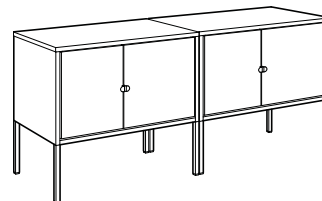

LIXHULT Floor-based storage combination

Total size: W47 $\frac{1}{4}$ "x D13 $\frac{3}{4}$ "x H22 $\frac{1}{2}$ ".

This combination \$80

Gray

192.791.77

Articles for this combination

LIXHULT Cabinet 23 $\frac{3}{8}$ "x13 $\frac{3}{4}$ ".

Gray 2 pcs

COMBINATIONS

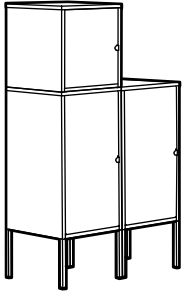

LIXHULT Floor-based storage combination

Total size: W27 1/2 x D13 3/4 x H46 1/8".

This combination \$105

Red/dark blue/dark green	292.486.80
Dark blue/red/orange	892.486.82

Articles for this combination

LIXHULT Cabinet 13 3/4 x 13 3/4".	Dark green or orange	1 pc
LIXHULT Cabinet 13 3/4 x 23 3/4".	Red or dark blue	2 pcs

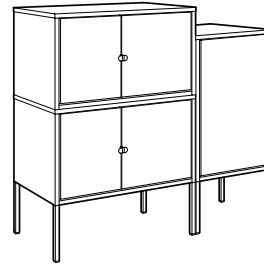

LIXHULT Floor-based storage combination

Total size: W37 3/8 x D13 3/4 x H36 1/4".

This combination \$120

Gray/dark blue	992.791.83
Gray/red	592.791.80

Articles for this combination

LIXHULT Cabinet 13 3/4 x 23 3/4".	Red or dark blue	1 pc
LIXHULT Cabinet 23 3/8 x 13 3/4".	Gray	2 pcs

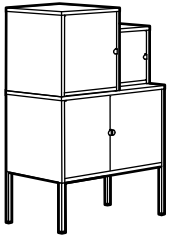

LIXHULT Floor-based storage combination

Total size: W23 3/8 x D13 3/4 x H36 1/4".

This combination \$80

Gray/orange/pink	292.487.36
Gray/dark green/pink	792.487.48

Articles for this combination

LIXHULT Cabinet 9 7/8 x 9 7/8".	White or pink	1 pc
LIXHULT Cabinet 13 3/4 x 13 3/4".	Dark green or orange	1 pc
LIXHULT Cabinet 23 3/8 x 13 3/4".	Gray	1 pc

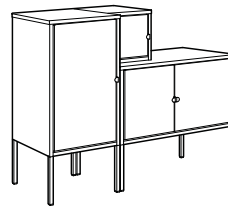

LIXHULT Floor-based storage combination

Total size: W37 3/8 x D13 3/4 x H32 1/4".

This combination \$95

Dark blue/gray/white	792.763.88
----------------------	------------

Articles for this combination

LIXHULT Cabinet 9 7/8 x 9 7/8".	White or pink	1 pc
LIXHULT Cabinet 13 3/4 x 23 3/8".	Red or dark blue	1 pc
LIXHULT Cabinet 23 3/8 x 13 3/4".	Gray	1 pc

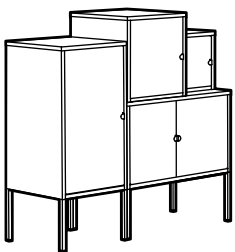

LIXHULT Floor-based storage combination

Total size: W37 3/8 x D13 3/4 x H36 1/4".

This combination \$120

Gray/white/orange/red	891.616.31
-----------------------	------------

Articles for this combination

LIXHULT Cabinet 9 7/8 x 9 7/8".	White or pink	1 pc
LIXHULT Cabinet 13 3/4 x 13 3/4".	Dark green or orange	1 pc
LIXHULT Cabinet 13 3/4 x 23 3/8".	Red or dark blue	1 pc
LIXHULT Cabinet 23 3/8 x 13 3/4".	Gray	1 pc

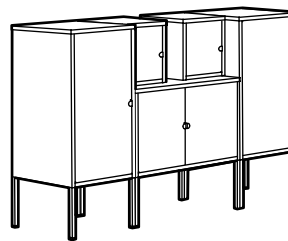

LIXHULT Floor-based storage combination

Total size: W51 1/8 x D13 3/4 x H32 1/4".

This combination \$150

Dark blue/gray/white/pink	092.488.55
---------------------------	------------

Articles for this combination

LIXHULT Cabinet 9 7/8 x 9 7/8".	White or pink	2 pcs
LIXHULT Cabinet 13 3/4 x 23 3/8".	Red or dark blue	2 pcs
LIXHULT Cabinet 23 3/8 x 13 3/4".	Gray	1 pc

COMBINATIONS

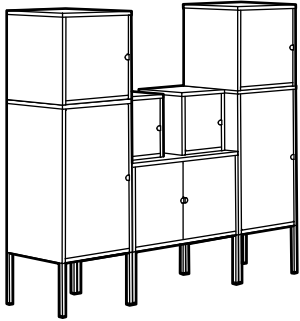

LIXHULT Floor-based storage combination

Total size: W51 $\frac{1}{8}$ ×D13 $\frac{3}{4}$ ×H46 $\frac{1}{8}$ ".

This combination \$200

Red/orange/gray/pink/white/blue/green 492.488.58

Articles for this combination

LIXHULT Cabinet 9 $\frac{1}{2}$ ×9 $\frac{1}{2}$ ".	White or pink	2 pcs
LIXHULT Cabinet 13 $\frac{3}{4}$ ×13 $\frac{3}{4}$ ".	Dark green or orange	2 pcs
LIXHULT Cabinet 13 $\frac{3}{4}$ ×23 $\frac{3}{8}$ ".	Red or dark blue	2 pcs
LIXHULT Cabinet 23 $\frac{3}{8}$ ×13 $\frac{3}{4}$ ".	Gray	1 pcs

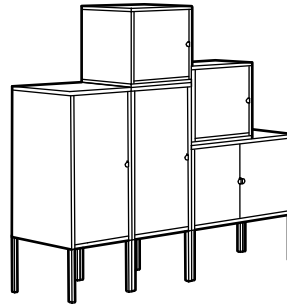

LIXHULT Floor-based storage combination

Total size: W51 $\frac{1}{8}$ ×D13 $\frac{3}{4}$ ×H46 $\frac{1}{8}$ ".

This combination \$170

Dark blue/red/orange/gray/dark green 292.488.64

Articles for this combination

LIXHULT Cabinet 13 $\frac{3}{4}$ ×13 $\frac{3}{4}$ ".	Dark green or orange	2 pcs
LIXHULT Cabinet 13 $\frac{3}{4}$ ×23 $\frac{3}{8}$ ".	Red or dark blue	2 pcs
LIXHULT Cabinet 23 $\frac{3}{8}$ ×13 $\frac{3}{4}$ ".	Gray	1 pcs

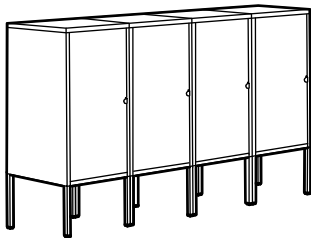

LIXHULT Floor-based storage combination

Total size: W55 $\frac{1}{8}$ ×D13 $\frac{3}{4}$ ×H32 $\frac{1}{4}$ ".

This combination \$160

Red 992.488.70

Blue 592.488.67

Articles for this combination

LIXHULT Cabinet 13 $\frac{3}{4}$ ×23 $\frac{3}{8}$ ".	Red or dark blue	4 pcs
---	------------------	-------

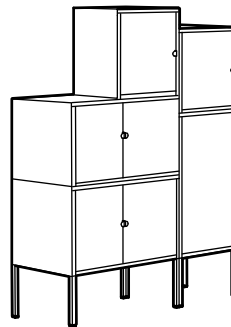

LIXHULT Floor-based storage combination

Total size: W37 $\frac{3}{8}$ ×D13 $\frac{3}{4}$ ×H50".

This combination \$170

Gray/dark green/red/orange 092.489.16

Articles for this combination

LIXHULT Cabinet 13 $\frac{3}{4}$ ×13 $\frac{3}{4}$ ".	Dark green or orange	2 pcs
LIXHULT Cabinet 13 $\frac{3}{4}$ ×23 $\frac{3}{8}$ ".	Red or dark blue	1 pcs
LIXHULT Cabinet 23 $\frac{3}{8}$ ×13 $\frac{3}{4}$ ".	Gray	2 pcs

COMBINATIONS

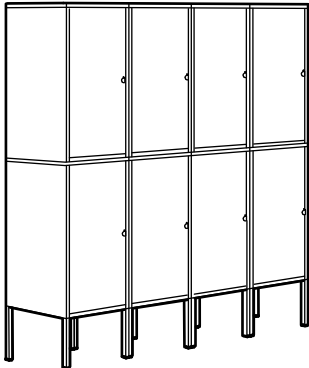

LIXHULT Floor-based storage combination
Total size: W55½×D13¾×H55⅞".

This combination \$320

Dark blue/red	492.489.19
Dark blue	692.791.89

Articles for this combination

LIXHULT Cabinet 13¾×23⅞".	Red or dark blue	8 pcs
---------------------------	------------------	-------

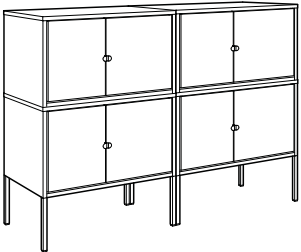

LIXHULT Floor-based storage combination
Total size: W47¼×D13¾×H36¼".

This combination \$160

Gray	292.791.86
------	------------

Articles for this combination

LIXHULT Cabinet 23⅞×13¾".	Gray	4 pcs
---------------------------	------	-------

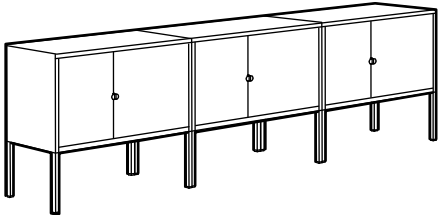
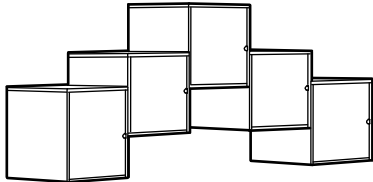

LIXHULT Floor-based storage combination
Total size: W70⅞×D13¾×H64⅞".

This combination \$245

Gray/dark green/orange	892.489.22
------------------------	------------

Articles for this combination

LIXHULT Cabinet 13¾×13¾".	Dark green or orange	5 pcs
LIXHULT Cabinet 23⅞×13¾".	Gray	3 pcs

ALL PARTS AND PRICES



LIXHULT Cabinet 9 $\frac{1}{2}$ "x9 $\frac{1}{2}$ "x9 $\frac{1}{2}$ ".

You can choose to install the door to the right or left, according to what fits the space best. Helps you keep track of small items like chargers, keys and wallets. Keep track of important papers, letters and newspapers by sorting them on the inside of the cabinet door.

Metal/white	503.286.65	\$15
Metal/pink	703.964.27	\$15



LIXHULT Cabinet 13 $\frac{3}{4}$ "x13 $\frac{3}{4}$ "x13 $\frac{3}{4}$ ".

You can choose to install the door to the right or left, according to what fits the space best. Keep track of important papers, letters and newspapers by sorting them on the inside of the cabinet door.

Metal/orange	903.286.68	\$25
Metal/dark green	503.964.28	\$25

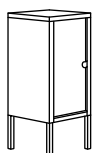

LIXHULT Cabinet W13 $\frac{3}{4}$ "x D13 $\frac{3}{4}$ "x H23 $\frac{3}{4}$ ".

You can choose to install the door to the right or left, according to what fits the space best. The cabinet can be used either with the included legs or be placed directly on the floor. Larger modules must be placed on the floor or with support of another floor based unit underneath. Do not mount this free-hanging on the wall. Max load/shelf 26 lbs. Height with legs 32 $\frac{1}{4}$ ".

Metal/dark blue	303.964.29	\$40
Metal/red	503.286.70	\$40

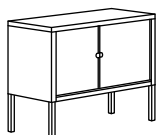

LIXHULT cabinet, W23 $\frac{3}{4}$ "x D13 $\frac{3}{4}$ "x H13 $\frac{3}{4}$ ".

The cabinet can be used either with the included legs or be placed directly on the floor. Larger modules must be placed on the floor or with support of another floor based unit underneath. Do not mount this free-hanging on the wall. Max load on top 11 lbs. Height with legs 22 $\frac{1}{2}$ ".

Metal/gray	703.286.69	\$40
------------	------------	-------------