

BUYING GUIDE

ELVARLI

Open storage system

DESIGN

Ehlén Johansson

SAFETY

The adjustable post must be attached to the ceiling. The side unit must be attached to the wall.

Secure It! Prevent tip-over injury. Furniture with included restraints must be secured to the wall according to the assembly instructions.

Different ceiling materials and wall materials require different types of hardware. Use hardware (sold separately) suitable for the ceiling or walls in your home.

CARE AND CLEANING

Wipe clean with a cloth dampened in a mild cleaner. Then dry with a clean, dry cloth.

GOOD TO KNOW

Max load for
ELVARLI shelves:

15¾" width

14¾" depth: 26 lbs.

2½" depth: 40 lbs.

31½" width

14¾" depth: 55 lbs.

20¾" depth: 79 lbs.

Max load for
ELVARLI clothes rails

15¾": 33 lbs.

31½": 66 lbs.

Max load for hook
9 lbs.

ASSEMBLY

IMPORTANT: Two people are required to assemble this furniture safely.

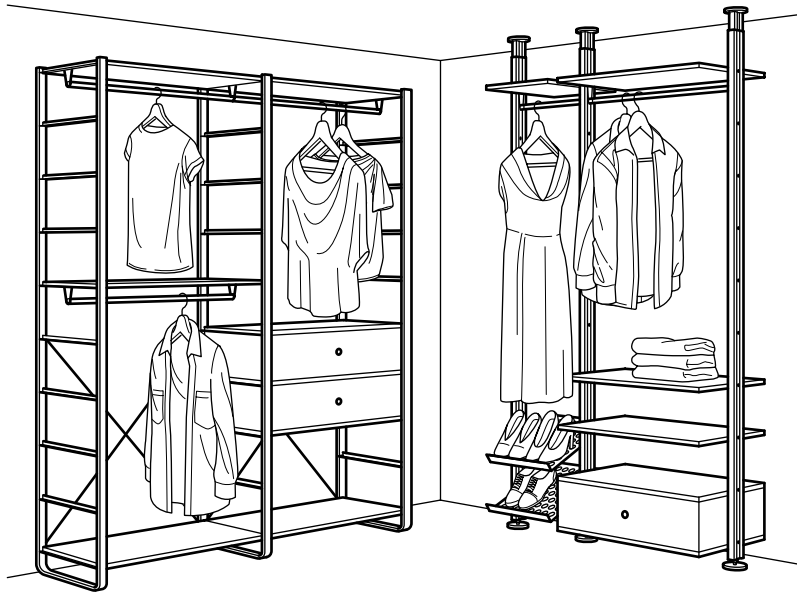

For storing clothes and shoes, ELVARLI is a flexible and beautiful open storage system with its modern white lines and durable bamboo shelves. Whether you take home a ready-made combination we've already planned or create your own solution, you get custom organization for your bedroom, hallway, living room or home office. Its click-in function makes it easy to assemble, disassemble and rearrange.

With ELVARLI, you choose a base: a ceiling-anchored post or a wall-anchored side unit. Then you add interiors – clothes rails, drawers, shelves, shoe shelves – to suit your storage needs. There are handy hooks available, too!

The choice is yours with ELVARLI. See everything at once with open shelves. Or go open and hidden with shelves and soft-closing drawers. Hang a lot of clothes or none at all. Whatever you choose, you can always adapt or extend ELVARLI if you change your mind, needs or address!

A high standard of accuracy has been sought in the preparation of this buying guide. We apologize for, but will not be bound by or responsible for, errors and omissions in this buying guide.

Not all products may be available in all stores. See what is available at your local store by visiting IKEA-USA.com/stockavailability. For more detailed product information, see the price tag or visit IKEA-USA.com. All products shown require assembly. All textiles shown are imported.



HOW TO PLAN

What do you want to store?

Sort through all the clothes you own. Count how many pieces you want to store in each category like shoes, dresses, sweaters, pants, etc.

How much space do you have?

Determine where you want your open storage solution. Sketch out the space, measuring from the floor to the ceiling and between the walls. Take detailed measurements, note any windows or doors and allow for opening and closing doors. Consider any radiators, pipes, ventilation or other features that could affect your storage solution.

Want a ready-made combination?

Browse the ready-made combinations in this buying guide and more solutions at IKEA-USA.com/ELVARLI. Our coworkers can help you compile a picking list of your chosen combination to guide you through the Self-Serve area. They can also help you with other services such as pick-up and arranging home delivery.

Want to create your own solution? Use the additional information provided in this buying guide to follow these simple steps:

1. Pick a base

ELVARLI can be made using a wall-anchored side unit (1) or a ceiling-anchored post (2) as a base. The post height is adjustable between 87¼" to 137¾". Each post includes two fittings which enable interiors to be mounted also on the extendable part. The side unit comes in two heights, 49½"

and 85". Remember! Every post must have brackets for each interior that you add (except for the clothes rail). Every side unit must have a cross-brace.

2. Choose the interiors

Clothes rails, shelves, inserts, drawers and shoe shelves are the ELVARLI interiors. Choose a combination of interiors to solve your specific storage needs. All interiors are available in two widths (15¾" and 31½") and two depths (14⅞" and 20⅞"). Remember! Although an insert can be used on its own as a compartment for boxes or folded clothes, every drawer must have an insert.

3. Calculate the width

Make sure your solution will fit in your chosen location. Whether you use posts or side units, you will need to allow for extra width. Calculate the width of your storage solution using the information on page 3.

Online planning

Put your creativity to work and create your own wardrobe combination. Our easy-to-use planners help you try out different ideas to find what's best for you. You can start from one of our ready-made solutions and adapt it or you can start from scratch. The planners tell you how much your combination will cost. It creates a list of the products you need, so you don't forget anything at the store. It also checks if what you need is available before you go. The planners even help you buy your products directly online. Start planning today at: IKEA-USA.com/ELVARLIplanner

①

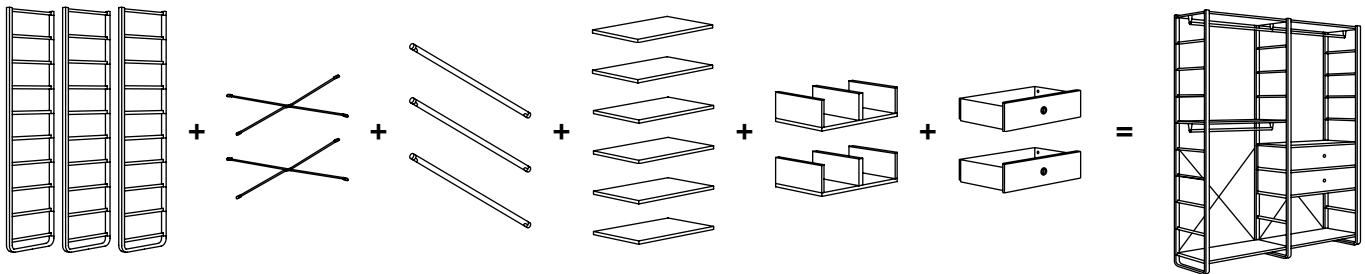

②

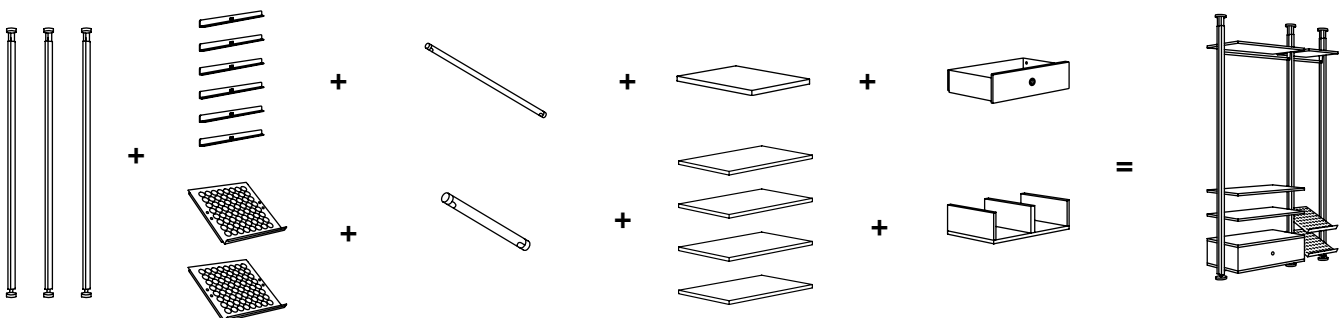

TIP! Organize and maximize

Complete your new storage solution with boxes and inserts from our extensive range of interior accessories. They help you get even more organized so everything is easy to find. Check out our favorites on page 8.

HOW TO BUILD

HOW TO CALCULATE THE WIDTH OF AN OPEN STORAGE SOLUTION

Widths of interiors (clothes rails, drawers, inserts, shelves, shoe shelves): 15¾" and 31½".

ELVARLI with post:

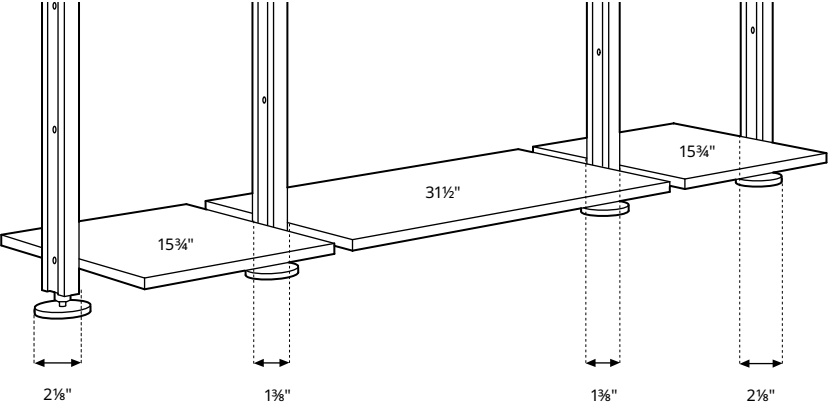

If you are planning your ELVARLI storage solution with post, you need to allow 1 3/8" for the width of each post.

ELVARLI combination with side unit:

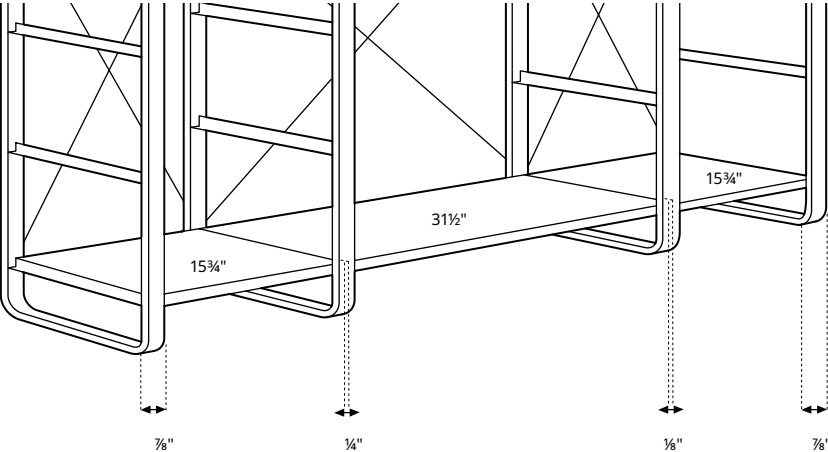

If you are planning your ELVARLI storage solution with side unit, you need to allow 7/8" for the width of the outer side units, and 1/4" for the width of the middle side units.

COMBINATIONS

Combinations with side unit. Width×Depth×Height.

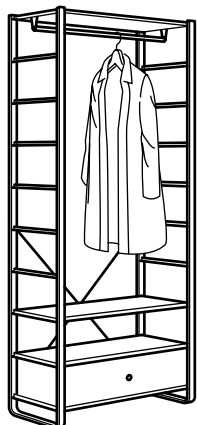

ELVARLI Combination

Overall size: 33¼×21½×85".

This combination \$260 591.573.53

Shopping list

Side unit 20½×85"	802.961.68	\$60/pc	2 pcs
Insert 31½×20½", White	202.961.85	\$25/pc	1 pcs
Drawer 31½×20½", White	402.962.07	\$40/pc	1 pcs
Shelf 31½×20½", White	102.961.76	\$20/pc	3 pcs
Cross-brace 31½", White	003.095.94	\$5/pc	1 pcs
Clothes rail 31½", White	002.962.14	\$10/pc	1 pcs

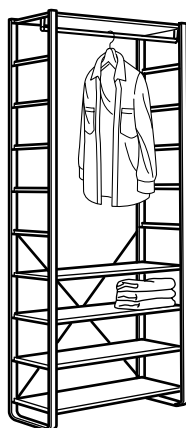

ELVARLI Combination

Overall size: 33¼×15¾×85".

This combination \$190 691.574.75

Shopping list

Side unit 14½×85", White	003.175.32	\$50/pc	2 pcs
Shelf 31½×14½", White	203.132.84	\$15/pc	5 pcs
Clothes rail 31½", White	002.962.14	\$10/pc	1 pc
Cross brace 31½", White	003.095.94	\$5/pc	1 pc



ELVARLI Combination

Overall size: 80¾×21¾×85".

This combination \$615 491.880.05

Shopping list

Side unit 20½×85", White	802.961.68	\$60/pc	4 pcs
Clothes rail 15¾", White	402.962.12	\$5/pc	1 pc
Clothes rail 31½", White	002.962.14	\$10/pc	3 pcs
Shelf 15¾×20½", White	602.961.74	\$15/pc	5 pcs
Shelf 31½×20½", White	102.961.76	\$20/pc	6 pcs
Insert 31½×20½", White	202.961.85	\$25/pc	2 pcs
Drawer 31½×20½", White	402.962.07	\$40/pc	2 pcs
Cross-brace 15¾", White	603.095.72	\$5/pc	1 pc
Cross-brace 31½", White	003.095.94	\$5/pc	2 pcs

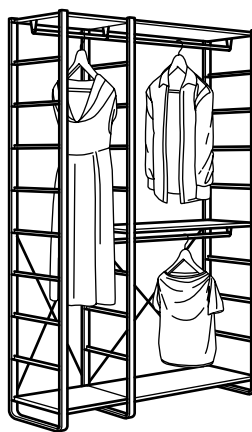

ELVARLI Combination

Overall size: 49½×21½×85".

This combination \$305 791.581.44

Shopping list

Side unit 20½×85"	802.961.68	\$60/pc	3 pcs
Shelf 31½×20½", White	102.961.76	\$20/pc	3 pcs
Shelf 15¾×20½", White	602.961.74	\$15/pc	2 pcs
Clothes rail 15¾", White	402.962.12	\$5/pc	1 pcs
Clothes rail 31½", White	002.962.14	\$10/pc	2 pcs
Cross-brace 15¾", White	603.095.72	\$5/pc	1 pcs
Cross-brace 31½", White	003.095.94	\$5/pc	1 pcs

COMBINATIONS

Combinations with side unit. Width×Depth×Height.



ELVARLI Combination

Overall size: 65×21½×85".

This combination \$765 991.575.77

Shopping list

Side unit 20½×85"	802.961.68	\$60/pc	4 pcs
Shelf 31½×20½", White	102.961.76	\$20/pc	2 pcs
Shelf 15¾×20½", White	602.961.74	\$15/pc	8 pcs
Insert 31½×20½", White	202.961.85	\$25/pc	3 pcs
Drawer 31½×20½", White	402.962.07	\$40/pc	3 pcs
Drawer 15¾×20½", White	802.962.05	\$30/pc	3 pcs
Insert 15¾×20½", White	702.961.83	\$15/pc	3 pcs
Clothes rail 15¾", White	402.962.12	\$5/pc	2 pcs
Clothes rail 31½", White	002.962.14	\$10/pc	1 pcs
Cross-brace 15¾", White	603.095.72	\$5/pc	2 pcs
Cross-brace 31½", White	003.095.94	\$5/pc	1 pcs

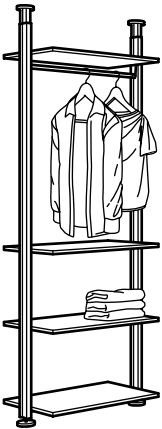

ELVARLI Combination

Overall size: 36½×20×87¼×137¾".

This combination \$170 991.579.02

Shopping list

Post 87¼-137¾", White	402.961.70	\$30/pc	2 pcs
Shelf 31½×20½", White	102.961.76	\$20/pc	4 pcs
Brackets for posts 20½", White, 2pk	002.961.72	\$5/2pk	4 pcs
Clothes rail 31½", White	002.962.14	\$10/pc	1 pc

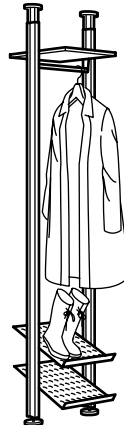

ELVARLI Combination

Overall size: 20¾×14½×87¼×137¾".

This combination \$100 291.576.08

Shopping list

Post 87¼-137¾", White	402.961.70	\$30/pc	2 pcs
Shelf 15¾×14½", White	603.132.82	\$10/pc	1 pcs
Brackets for posts 14½", White, 2pk	003.175.27	\$5/2pk	1 pcs
Clothes rail 15¾", White	402.962.12	\$5/pc	1 pc
Shoe shelf 15¾×14½", White	103.172.92	\$10/pc	2 pcs

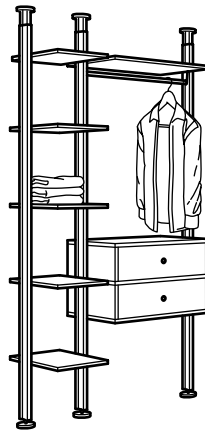

ELVARLI Combination

Overall size: 53½×20×87¼×137¾".

This combination \$390 091.581.52

Shopping list

Post 87¼×137¾", White	402.961.70	\$30/pc	3 pcs
Shelf 15¾×20½", White	602.961.74	\$15/pc	5 pcs
Shelf 31½×20½", White	102.961.76	\$20/pc	2 pcs
Insert 31½×20½", White	202.961.85	\$25/pc	2 pcs
Drawer 31½×20½", White	402.962.07	\$40/pc	2 pcs
Clothes rail 31½", White	002.962.14	\$10/pc	1 pc
Brackets for posts 20½", White, 2pk	002.961.72	\$5/2pk	9 pcs

COMBINATIONS

Combinations with post. Width×Depth×Height.

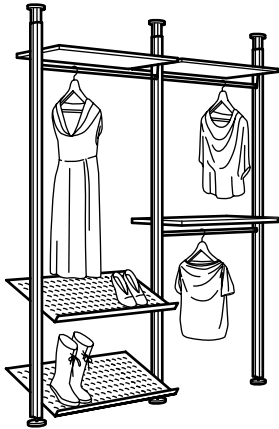

ELVARLI Combination

Overall size: 68 $\frac{7}{8}$ ×20×87 $\frac{1}{4}$ ×137 $\frac{3}{4}$ ".

This combination \$225 591.575.41

Shopping list

Post 87 $\frac{1}{4}$ ×137 $\frac{3}{4}$ ", White	402.961.70	\$30/pc	3 pcs
Shelf 31 $\frac{1}{2}$ ×20 $\frac{1}{8}$ ", White	102.961.76	\$20/pc	3 pcs
Clothes rail 20", White	002.962.14	\$10/pc	3 pcs
Brackets for posts 31 $\frac{1}{2}$ ", White 2pk	002.961.72	\$5/2pk	3 pcs
Shoe shelf 20 $\frac{1}{8}$ ×14 $\frac{1}{8}$ ", White	503.172.90	\$15/pc	2 pcs

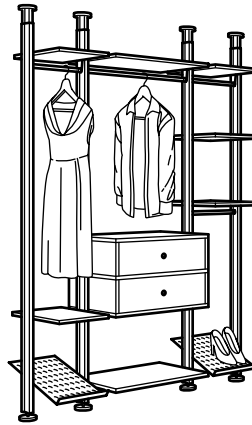

ELVARLI Combination

Overall size: 70 $\frac{1}{4}$ ×20×87 $\frac{1}{4}$ ×137 $\frac{3}{4}$ ".

This combination \$475 491.575.46

Shopping list

Post 87 $\frac{1}{4}$ -137 $\frac{3}{4}$ ", White	402.961.70	\$30/pc	4 pcs
Shelf 15 $\frac{3}{4}$ ×20 $\frac{1}{8}$ ", White	602.961.74	\$15/pc	5 pcs
Shelf 31 $\frac{1}{2}$ ×20 $\frac{1}{8}$ ", White	102.961.76	\$20/pc	3 pcs
Insert 31 $\frac{1}{2}$ ×20 $\frac{1}{8}$ ", White	202.961.85	\$25/pc	2 pcs
Drawer 31 $\frac{1}{2}$ ×20 $\frac{1}{8}$ ", White	402.962.07	\$40/pc	2 pcs
Clothes rail 15 $\frac{3}{4}$ ", White	402.962.12	\$5/pc	2 pcs
Clothes rail 31 $\frac{1}{2}$ ", White	002.962.14	\$10/pc	1 pcs
Shoe shelf 15 $\frac{3}{4}$ ×14 $\frac{1}{8}$ ", White	103.172.92	\$10/pc	2 pcs
Brackets for posts 20 $\frac{1}{8}$ ", White, 2pk	002.961.72	\$5/2pk	10 pcs

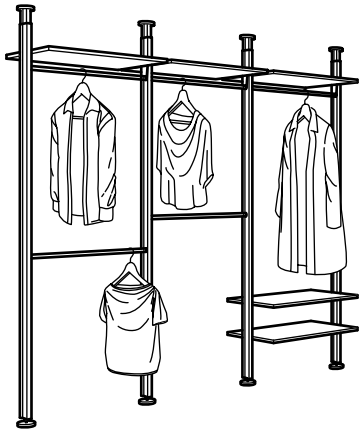

ELVARLI Combination

Overall size: 101 $\frac{5}{8}$ ×20×87 $\frac{1}{4}$ -137 $\frac{3}{4}$ ".

This combination \$295 991.573.70

Shopping list

Post 87 $\frac{1}{4}$ -137 $\frac{3}{4}$ ", White	402.961.70	\$30/pc	4 pcs
Clothes rail 31 $\frac{1}{2}$ ", White	002.962.14	\$10/pc	5 pcs
Shelf 31 $\frac{1}{2}$ ×20 $\frac{1}{8}$ ", White	102.961.76	\$20/pc	5 pcs
Brackets for posts 20 $\frac{1}{8}$ ", White, 2pk	002.961.72	\$5/2pk	5 pcs

ALL PARTS AND PRICES



ELVARLI Side unit White

D14 $\frac{1}{8}$ ×W85"	003.175.32	\$50
D20 $\frac{1}{8}$ ×W85"	802.961.68	\$60



ELVARLI Post White

H87 $\frac{1}{4}$ ×137 $\frac{3}{4}$ "	402.961.70	\$30
--	------------	-------------

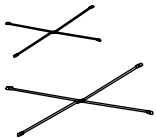

ELVARLI Cross-brace White

W15 $\frac{3}{4}$ "	603.095.72	\$5
W31 $\frac{1}{2}$ "	003.095.94	\$5



ELVARLI Bracket for post White

D14 $\frac{1}{4}$ "	003.175.27	\$5
D20"	002.961.72	\$5

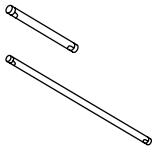

ELVARLI Clothes rail White

W15 $\frac{3}{4}$ "	402.962.12	\$5
W31 $\frac{1}{2}$ "	002.962.14	\$10



ELVARLI Hooks White

	502.962.16	\$5/2pk
--	------------	----------------

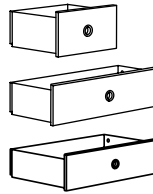

ELVARLI Drawer White

W15 $\frac{3}{4}$ ×D20 $\frac{1}{8}$ "	802.962.05	\$30
W30 $\frac{1}{2}$ ×D14 $\frac{1}{8}$ "	703.132.72	\$35
W30 $\frac{1}{2}$ ×D20 $\frac{1}{8}$ "	402.962.07	\$40

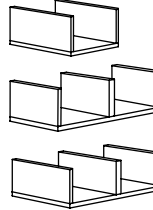

ELVARLI Insert White

W15 $\frac{3}{4}$ ×D20 $\frac{1}{8}$ ×H9 $\frac{3}{4}$ "	702.961.83	\$15
W31 $\frac{1}{2}$ ×D14 $\frac{1}{8}$ ×H9 $\frac{3}{4}$ "	403.132.78	\$20
W31 $\frac{1}{2}$ ×D20 $\frac{1}{8}$ ×H9 $\frac{3}{4}$ "	202.961.85	\$25

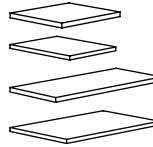

ELVARLI Shelf White

W15 $\frac{3}{4}$ ×D14 $\frac{1}{8}$ "	603.132.82	\$10
W15 $\frac{3}{4}$ ×D20 $\frac{1}{8}$ "	602.961.74	\$15
W31 $\frac{1}{2}$ ×D14 $\frac{1}{8}$ "	203.132.84	\$15
W31 $\frac{1}{2}$ ×D20 $\frac{1}{8}$ "	102.961.76	\$20

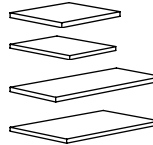

ELVARLI Shelf Bamboo

W15 $\frac{3}{4}$ ×D14 $\frac{1}{8}$ "	903.192.68	\$20
W15 $\frac{3}{4}$ ×D20 $\frac{1}{8}$ "	202.962.89	\$25
W31 $\frac{1}{2}$ ×D14 $\frac{1}{8}$ "	703.192.69	\$30
W31 $\frac{1}{2}$ ×D20 $\frac{1}{8}$ "	802.962.91	\$35

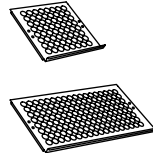

ELVARLI Shoe shelf White

W15 $\frac{3}{4}$ ×D14 $\frac{1}{8}$ "	103.172.92	\$10
W31 $\frac{1}{2}$ ×D14 $\frac{1}{8}$ "	503.172.90	\$15

INTERIOR ACCESSORIES

Complete your new storage solution with your choice of boxes and inserts from our extensive range of interior accessories. They give you even more options for a smarter way to store all your clothes.

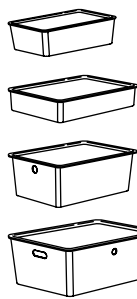

KUGGIS Box with lid White

7×10¼×3¼"	202.802.07	\$3.99
10¼×13¾×3¼"	502.823.04	\$5.99
10¼×13¾×6"	602.802.05	\$7.99
14½×21¼×8¼"	102.802.03	\$14.99



KUGGIS Insert with eight compartments White

20¾×14⅞×2¼"	002.802.08	\$7
-------------	------------	------------

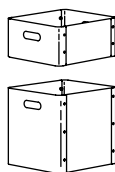

BULLIG Box Black

12½×13¾×13"	104.096.25	\$16.99
-------------	------------	----------------



FLÅDIS Basket

Ø9½"	603.221.73	\$12.99
------	------------	----------------

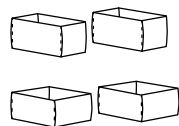

KOMPLEMENT Boxes Light gray

6×10½×4¾"	104.040.53	\$9.99/2pk
9¾×10½×4¾"	404.057.77	\$12.99/2pk

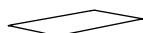

KOMPLEMENT Drawer mat 35×20⅞"

Light gray	304.055.65	\$7
------------	------------	------------



VARIERA Cover caps

White	002.263.15	\$1.29/ 100pk
-------	------------	--------------------------

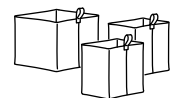

RAGGISAR Baskets Includes: two pieces 7½×5×7" and one piece 10×10×7".

Gray	304.343.32	\$6.99/ set of 3
------	------------	-----------------------------

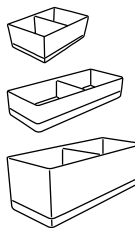

STUK Box with compartments White/gray

7¾×13½×4"	703.640.06	\$3.99
7¾×20×4"	003.095.51	\$4.99
7¾×20×7"	603.095.86	\$5.99

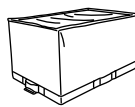

STUK Storage case White/gray

13½×20×11"	003.096.88	\$6.99
21¾×20×7"	803.095.90	\$7.99
28×20×7"	503.095.82	\$8.99

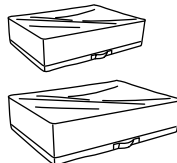

TJENA Box with lid 7×9¾×6".

Black	603.954.85	\$1.99
Green dotted	304.340.54	\$1.99
White	103.954.21	\$1.99
Yellow	904.341.31	\$1.99

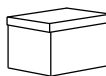

TJENA Box with lid 9¾×13¾×7¾".

Black	303.954.77	\$3.99
Green dotted	604.340.57	\$3.99
White	603.954.28	\$3.99
Yellow	304.341.34	\$3.99



BUMERANG Hangers

Black	202.385.34	\$5.49/8pk
Natural	302.385.43	\$4.49/8pk
White	702.385.41	\$5.49/8pk