

ÖSTVEDA

en

905.681.49

105.681.48



Design and Quality
IKEA of Sweden

Table of contents

Safety information	4	Loading the detergent	29
Safety instruction	8	Hints and tips	32
Product description	12	Cleaning and maintenance	33
Before first use	13	Troubleshooting	35
Basic settings and program selection	15	Environmental concerns	39
Options and settings	18	IKEA guarantee	39
Basket loadability and settings	25		

Thank you for choosing this product.

We are proud to offer the ideal product for you and the best complete range of home appliances for your daily routine.

Carefully read this manual for correct and safe appliance use and for helpful tips on efficient maintenance.

Safety information

Only use the dish washer after carefully reading these instructions. We recommend you always keep this manual to hand and in good condition for any future owner.

General safety rules

A different use of this appliance from household environment or from typical housekeeping functions, as commercial use by expert or trained users, is excluded even in the above applications.

If the appliance is used in a manner inconsistent with this it may reduce the life of the appliance and may void the manufacturer's warranty. Any damage to the appliance or other damage or loss arising through use that is not consistent with domestic or household use (even if located in a domestic or household environment) shall not be accepted by the manufacturer to the fullest extent permitted by law.

The appliance can be used by those aged 8 or over and by those with limited physical, sensorial or mental capacities, without experience or knowledge of the product, only if supervised or provided with instruction as to the operation of the appliance, in a safe way with awareness of the possible risks.

- Children should be supervised to ensure that they do not play with the appliance.
- Children of aged 3 and under should be kept away unless continuously supervised.
- If the supply cord is damaged, it must be replaced by a special cord or assembly available from the manufacturer or its service agent.
- Only use the hose-sets supplied with the appliance for the water supply connection (do not reuse old hose-sets).

- Water pressure must be between 0.08 MPa and 1 MPa.
- Make sure carpets or rugs do not obstruct the base or any of the ventilation openings.
- After installation, the appliance must be positioned so that the power plug is easily accessible. If this is not possible, the fixed electrical installation must be equipped with a disconnecting device in accordance with the installation regulations.
- Do not leave the door open in a horizontal position, in order to avoid potential dangers (e.g. tripping).
- For further information on the product or to consult the technical data sheet, please refer to the manufacturer's website.
- For the maximum number of place settings, see the relevant rating plate attached to the product.

Electrical connections and safety instructions

- The technical details (supply voltage and power input) are indicated on the product rating plate.
- Make sure that the electrical system is earthed and complies with all applicable laws, and that the socket is compatible with the plug of the appliance. The manufacturer declines all responsibility for any damage to people or property due to non-earthing of the machine.
- Ensure that the dishwasher does not crush power cables.
- In general it is not advisable to use adaptors, multiple plugs and/or extension cables.



WARNING: The appliance must not be supplied through an external switching device, such as a timer, or connected to a circuit that is regularly switched on and off by a utility.



• Before cleaning or maintaining the dishwasher, unplug the appliance and turn off the water supply.

- Do not pull on the power cord or appliance to unplug the machine.



ATTENTION: Water may reach high temperatures during the wash cycle.

- Do not leave the appliance exposed to the elements (rain, sun, etc.).
- Leaning or sitting on the open door of the dishwasher could cause it to tip over.
- When moving, do not lift the dishwasher by the door; during the transport, never lean the door on the trolley. We recommend two people lift the machine.
- The dishwasher is designed for normal kitchen utensils. Objects that have been contaminated by petrol, paint, traces of steel or iron, corrosive chemicals, acids or alkalis must not be washed in the dishwasher.
- If there is a water softening device installed in the home there is no need to add salt to the water softener fitted in the dishwasher.
- If the appliance breaks down or stops working properly, switch it off, turn off the water supply and do not tamper with it. Repair work should only be carried out by an approved service agent and only genuine spare parts should be fitted. Any failure to follow the above advice may have serious consequences for the safety of the appliance.
- If you need to move the machine after removing the packaging, do not try to lift it by the bottom of the door. Open the door slightly and lift the machine by holding it on the top.

By C€ marking this product, we confirm, under our own responsibility, full compliance of this product with all relevant safety, health and environmental requirements under European legislation.

-  **WARNING:** Knives and other utensils with sharp points must be loaded in the basket with their points down or placed in a horizontal position.

Safety instruction

Installation

- Remove all elements of the packaging.

 **WARNING:** Keep packaging materials away from children.

- Do not install or use the dishwasher if it is damaged.
- Follow the instructions supplied with the product.

 **WARNING:** Do not connect the dishwasher to the mains supply until all installation operations have been performed according to the "ASSEMBLY INSTRUCTION".

 **WARNING:** Do not connect the dishwasher to the mains supply until the front panel has been fully installed. Otherwise, the risk of an electrical hazard may persist.

 **WARNING:** Ensure that the product, before being switched on for the first time, is installed in a horizontal position by way of the adjustable feet. Check the horizontal position using a spirit level.

Replacement of the inlet hose

- In case of breakage, the hose must be replaced with an original spare part available from the manufacturer or its service center.

Service

- To repair the appliance contact the Authorised Service Centre. Use original spare parts only.
- Please note that self-repair or nonprofessional repair can have safety consequences and might void the guarantee.

Water connection

The appliance must be connected to the water mains using new hose-sets. The old hose-sets should not be reused.

- The inlet and drain hoses can be directed to left or right.

The dishwasher can be connected to either cold or hot water, as long as it is no hotter than 60°C.

- Water pressure must be between 0,08 MPa and 1 MPa.
- The inlet hose must be connected to a tap so that the water supply can be cut off when the machine is not in use (**fig.1**).

- The dishwasher is fitted with 3/4" threaded connector (**fig.2**).
- Connect inlet hose "A" to water tap "B" with a 3/4" attachment making sure that it has been properly tightened. For nordic countries (FI SE NO DK) there is necessity to use adapter (see assembly instruction).
- If it is necessary, the inlet pipe can be lengthened up to 2,5 m. The extension pipe is available from the After Sales Service Centre.

- If the dishwasher is connected to new pipes or to pipes which have not been in use for a long time run water through for a few minutes before connecting the inlet hose. In this way no deposits of sand or rust will clog up the water inflow filter.

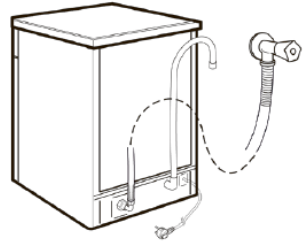

(fig.1)

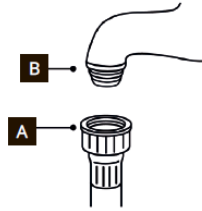

(fig.2)

Hydraulic safety devices

All the dishwashers are equipped with an overflow safety device which, if water exceeds normal levels due to malfunctions, automatically blocks water flow and/or drains excess quantities.

AQUASTOP (fig.3):

A device located on the supply tube that stops water flow if the tube deteriorates; in this case, a red mark will appear in the **window "C"** and the tube must be replaced.

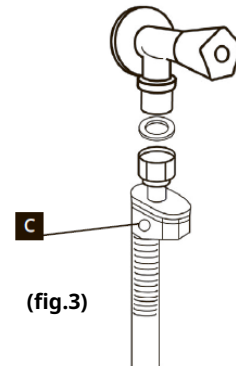

(fig.3)

Connecting the outlet hose

- The outlet hose should discharge into a standpipe, making sure that there are no kinks (fig.4).
- The standpipe must be at least 40 cm above floor level and it must have an internal diameter of at least 4 cm.
- It is advisable to fit an anti-odor air trap (fig.4X). If necessary the hose can be extended up to 2,5 m, provided that it is kept at a maximum height of 85 cm above floor level. The extension pipe is available from the After Sales Service Centre.
- The hose can be hooked over the side of the sink, but it must not be immersed in water, in order to prevent water from being syphoned back to the machine when this is in operation (fig.4Y).
- When installing the appliance under a worktop the hose pipe clamp must be attached to the wall in the highest possible position under the worktop (fig.4Z).
- Check that there are no kinks in the inlet and outlet hoses.

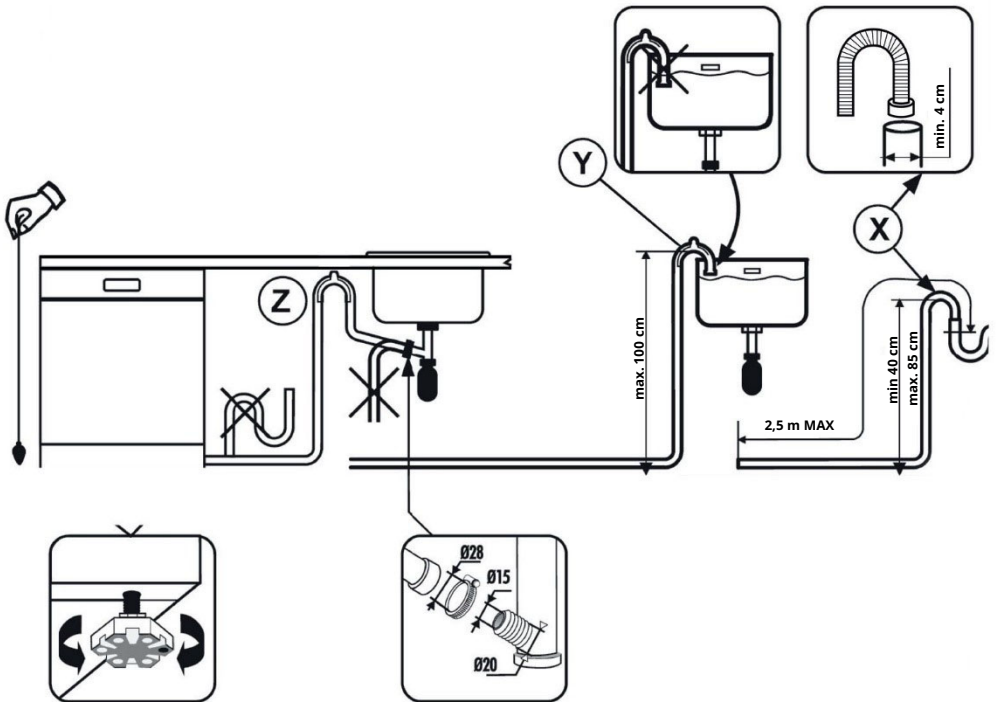

(fig.4).

Product description

- 1** Third spray arm
- 2** Lower spray arm
- 3** Filters
- 4** Rating plate
- 5** Salt container
- 6** Rinse aid dispenser
- 7** Detergent dispenser
- 8** Lower basket
- 9** Upper spray arm
- 10** Upper basket
- 11** Third basket

i The graphics is a general overview. For more details, refer to other chapters or documents provided with the appliance.

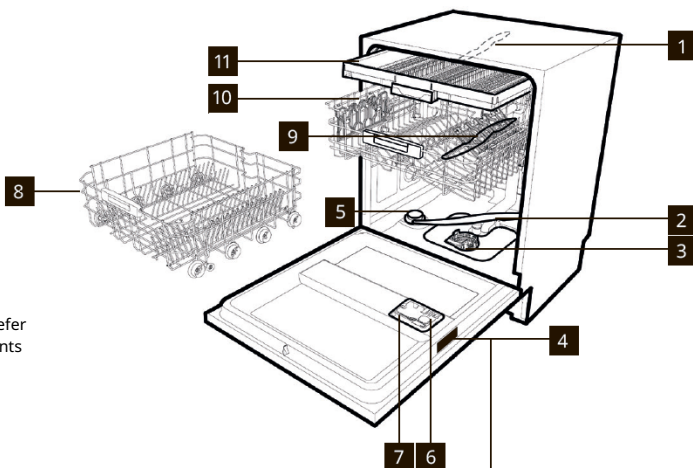

Serial number

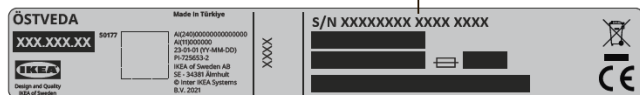

TECHNICAL DATA (see rating plate)

DATA	FULL- INTEGRATED
	Width x Height x Depth (cm)
	59,8x81,8x55

Place settings (EN 50242)	14
Capacity with pans and dishes	9 people
Water supply pressure (MPa)	Min 0,08 - Max 1 Mpa
Fuse / Power input / Supply voltage	10A / 2000W / 220-240 V

Before first use

Loading the salt

- The appearance of white stains on dishes is generally a warning sign that the salt container needs filling.
- On the bottom of the machine there is a container for the salt for regenerating the softener.
- It is important to use only a salt that is specifically designed for dishwasher. Other types of salt contain small quantities of insoluble particles which over a long period of time may affect and deteriorate the softener performance.
- To add salt, unscrew the cap of the container on the bottom (fig.5) and then refill the container. (fig.6)
- During this operation a little water will overflow; but keep adding salt until the container is full. When the container is full, mix salt and water (see fig.7) clean the thread of salt residue and retighten the tap. (fig.8)

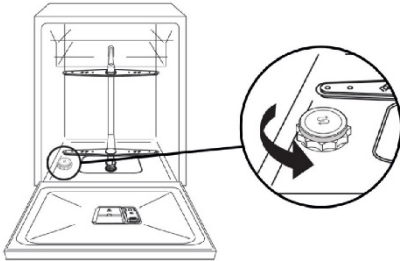

(fig.5)

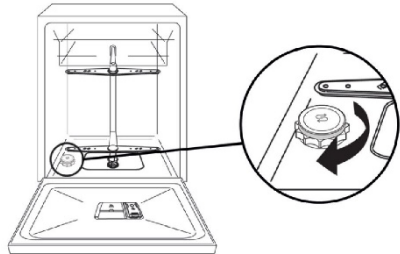

(fig.8)

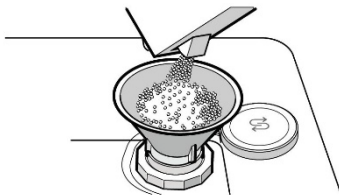

(fig.6)

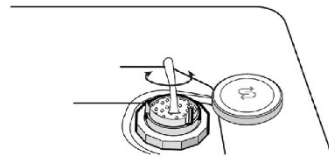

(fig.7)

After loading the salt, YOU MUST run a complete washing cycle, or the PRE-WASH/programme.

- The salt dispenser has a capacity of between 1 kg and, for efficient use of the appliance, it should be refilled from time to time.

(Only for first start up)

When the appliance is used for the first time, after completely filling the salt container, it is necessary to add water until the container overflows.

Loading the rinse aid

Rinse aid

Rinse aid, which is automatically released during the last rinsing cycle, helps the dishes to dry quickly and prevents spots and stains forming.

Filling the rinse aid container

The rinse aid container is next to the detergent container **(fig.9)**.

To open, press the tab on the lid of the rinse aid dispenser and lift it.

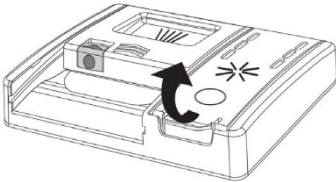

(fig.9)

Add rinse aid up to the Max. indication. **(fig.10)**

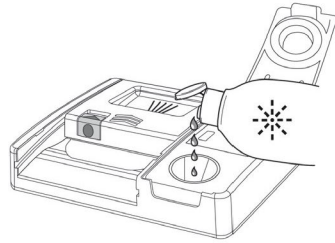

(fig.10)

- If the rinse aid spills out, remove it from the wash tank.
- Spilled rinse aid can cause excessive frothing during the wash cycle.
- Close the lid of the rinse aid dispenser.
- The lid clicks into the locking position.

Always use rinse additives that are suitable for automatic dishwashers.

Basic settings and program selection

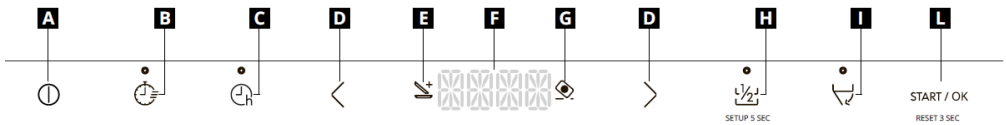

A ON/OFF button

B EXPRESS button

C DELAY START button

D PROGRAMME SELECTION button

E ADDISH light

F DISPLAY

G TABLET light

H HALF LOAD /setup 5 sec button

I AUTO DOOR OPEN button

L START / OK / reset 3 sec

First use setting

ON/OFF button

- To turn the appliance on and off, press the "ON/OFF"  button.

First time you switch on the appliance

- Connect the machine to the power supply.
- Press the "ON/OFF"  button.









In this phase, only the "PROGRAMME SELECTION"  and "START/OK" buttons will remain active.

- The "SET LANGUAGE" message will appear on the display, followed by "ENGLISH".
- By pressing the "PROGRAMME SELECTION"  button you can select the preferred language.

- To accept the choice of language, press the "START/OK" button. Immediately after, the "WELCOME" message will appear on the display just once and the lights will all be off.
- The pre-set "ECO" programme will appear on the display.
- To adapt the wash cycle to the type of dirty dishes, choose the suitable programme by selecting the two "PROGRAMME SELECTION"  buttons.
- Select the washing options if necessary.
- Press the "START/OK" button.

-  **WARNING:** In the event that the machine remains switched on without selecting or starting any programme, the dishwasher will switch off automatically after 5 minutes.

Program overview

Programme			Description
P1		ECO	Standard and most efficient programme in terms of combined energy and water consumption for normally soiled dish. EN60436-standardized programme.
P2		AUTO WASH	A programme that automatically selects the most efficient and effective duration and temperature of the cycle depending on the load and degree of grime.
P3		RAPID 1h	This is a full load programme designed to wash and dry in less than an hour, maintaining high quality wash performance.
P4		UNIVERSAL	Suitable for everyday light soiled dishes, your daily reference programme.
P5		INTENSIVE	For heavily soiled pans and any other items that require a strong and effective wash. Perfectly designed for very dirty plates, pans, and pots.
P6		GLASS	A gentle cleaning cycle for your most precious delicate dishes and crystals. A dedicated programme that protects the lifespan of your glassware.
P7		SILENT	The perfect programme designed to reduce dishwasher noise to the minimum.
P8		PREWASH	Short, pre-wash for dishes used during the day, when you want to wait until you have a full load.









Programmes with prewash

For wash programmes with prewash, it is advisable to add a second dose of detergent (max. 6 g) directly into the appropriate location. (see chapter "Loading the detergent").

Information for test institutes

To receive the necessary information for conducting performance tests (e.g. according to: EN60436), send an email to: info.test@dishwasher-production.com

In your request, include the product number code (PNC) from the rating plate.

Programme			Detergent for soaking (Prewash)	Washing temperature °C	Average (min.) wash duration ²	"HALF LOAD" button ¹	Power wash	"AUTO DOOR OPEN" button ¹	"TABLETS" button ²
P1	 ECO	ECO	-	45	235	YES	-	YES	YES
P2	 AUTO	AUTO WASH	-	55-65	120-140	YES	YES	YES	YES
P3	 RAPID 1h	RAPID 1h	●	65	59	YES	YES	YES	YES
P4	 UNIVERSAL	UNIVERSAL	-	60	129	YES	YES	YES	YES
P5	 INTENSIVE	INTENSIVE	●	75	146	YES	YES	YES	YES
P6	 GLASS	GLASS	-	45	96	YES	-	YES	YES
P7	 SILENT	SILENT	-	55	255	YES	-	YES	YES
P8	 PREWASH	PREWASH	-	-	10	YES	-	YES	N/A

● = Add detergent for prewash

1 = Only if function is activated via **SETTINGS**.







2 = With cold water (15°C) - Tolerance ±10%

With hot water the time remaining until the end of the programme is automatically displayed while the programme is running.

*Values are measured in a laboratory according to European Standard **EN60436** (consumption may vary according to conditions of usage).

The **ECO** programme is suitable for cleaning normally soiled tableware and is the most efficient programme for this use in terms of combined energy and water consumption. Furthermore, this programme is used by regulatory authorities to assess compliance with EU ecodesign legislation.

Except for the **ECO** programme, the values given for other programmes are indicative only. The cycle duration may be influenced by numerous factors, such as water temperature, main water pressure, environmental temperature, the amount of detergent used and the number and distribution of dishes in the loading racks.

Programme	Water consumption (l)	Electricity consumption (kWh)
ECO	9,5	0,74
AUTO	13,4	1,2
 1h	12,6	1,4
	14,6	1,3
	18,1	1,9
	15,1	1,1
	14,6	1,4
	4,6	0,1

1) The pressure and the temperature of the water, the variations of the mains supply, the options, the quantity of dishes and the degree of soil can change the values.

2) The values for programmes other than ECO are indicative only.

3) ECO program: values refer to full load conditions with the door opening option active, as per European standard **EN60436**.

Options and settings

ADDISH (option to add dishes after the programme has started)

When the programme starts, you should only open the door and add more dishes when the **ADDISH** indicator light is switched on.

The appliance will stop automatically and the time remaining to the end of the cycle will flash on the display. Close the door, **without pressing any buttons**.

Open the door slowly and carefully, to avoid getting splashed by washing water.

Adding dishes after the ADDISH indicator light has switched off is strongly discouraged as this could affect the wash performance.

 **WARNING:** If you open the door during the drying cycle, an intermittent audio signal advises you that the drying cycle has not yet finished.

Interrupting a programme

Opening the door when a programme is running is not recommended especially during the main wash and final hot rinse phases. However, if the door is opened while a programme is running (for example, to add dishes) the machine stops automatically. Close the door, without pressing any buttons.

The cycle will restart from where it left off.

 **WARNING:** If you open the door during the drying cycle, an intermittent audio signal advises you that the drying cycle has not yet finished.

Changing a running programme

If you want to cancel and change a programme that is already in progress, proceed as follows:

- 1 Press and hold the **"RESET 3 SEC"** button for at least 3 seconds.
- 2 The countdown appears on the display **"3 -2 -1"** while the **"RESET 3 SEC"** button is held down.
- 3 **"RESET"** will appear on the display and beeps will sound.
- 4 The programme in progress will be cancelled and the **"ECO"** program appears on the display.
- 5 At this point you can set a new programme using the **"PROGRAMME SELECTION" <>** keys.

 **WARNING:** Before starting a new programme, you should check that there is still detergent in the dispenser. If necessary, top up the detergent.

End of the programme

The end of the program is indicated by a single prolonged acoustic signal. After one minute, the dishwasher turns off. Simultaneously, the message "END" appears on the display for one minute.

AUTO DOOR OPEN

The door will open automatically during the drying phase and you will have to wait for the end-of-cycle signal before removing the dishes.

"EXPRESS" button

This button enables average energy and time savings of 25% (according to the cycle selected), reducing the wash-water temperature and the drying time during the final rinse. This option is recommended for evening washing when perfectly dry dishes are not needed immediately. For better drying, leave the dishwasher door slightly ajar to promote natural air circulation in the dishwasher.

HALF LOAD/SETUP 5 SEC

This key allows you to select two different functions:

"HALF LOAD" button

Specially developed for lightly soiled small loads that fits approximately half of the dishwasher. Selecting this option can save you time, energy and water.

After selecting the programme, press the button and the indicator light will come on. If this option is not compatible with the set programme, a sound will be heard.

Washing basket selection

Each time the half load button is pressed, the wash basket will appear on the display.

 Both baskets.

 Lower basket.

 Upper basket.

In models with a 3rd basket, it will always be active.



SETTINGS

The dishwasher comes with certain factory settings. However, you can adapt the various parameters to your washing needs from the settings menu.

The following parameters can be adjusted
Language--> Tablets-->Softener-->Rinse Aid--> Buzzer

ALWAYS start the procedure with the dishwasher turned off.

Language Settings

- Switch the dishwasher on with the "ON/ OFF"  button.
- Keep the "SETUP 5 SEC" button pressed for about 5 sec.
- The "SETTINGS" message appears on the display.
- By pressing the "PROGRAM SELECTION"  key you can select the successive parameters to be adjusted.
- Select the "LANGUAGE" setting that appears on the display.
- Press the "START/OK" button to confirm the selected parameter.
- "ENGLISH" appears on the display.
- Press the "PROGRAM SELECTION"  buttons to choose a new language.

- Press the "START/OK" to confirm the chosen language has been set, "LANGUAGE" will be displayed and a short sound will be heard.
- To exit the menu, press the "ON/OFF"  key.



"TABLETS"

"TABLETS" OPTION SETUP 5 SEC

This option enables optimal tablet usage ("3 in 1"/ "4 in 1"/ "5 in 1", etc.). By pressing this button, the set washing programme is changed, in order to obtain optimum performance using tablets or combined detergents; in addition, the salt and rinse aid indicators are deactivated.

-  **WARNING:** Once selected, this option also remains active (light on) for subsequent washing cycles and can only be de-activated (light off) by deselecting the option.

This option is recommended when using the RAPID programme, whose duration will be extended to enable improved performance from the detergent tablets.





- Switch on the dishwasher with the "ON/ OFF"  button.
- Keep the "SETUP 5 SEC" button pressed for about 5 sec.
- The "SETTINGS" message appears on the display.
- By pressing the "PROGRAM SELECTION"  key you can select the successive parameters to be adjusted.
- Select the "TABLETS" setting.
- Press the "START/OK" button to confirm the selected parameter.
- Press the "PROGRAM SELECTION"  buttons to choose the two settings:
 - "YES"**
 - "NO"**
- Confirm your choice by pressing "START/OK"

- If the "YES" setting is confirmed, "TABLETS" light icon will turn on the display.
- If the "NO" setting is confirmed, "TABLETS" light icon will turn off.
- To exit the menu, press the "ON/OFF" key.

BUZZER SELECTIONS AND SETTINGS

The buzzer signal that sounds upon pressing the keys used for selecting and setting washing functions and options can be activated/ deactivated as follows (it is activated by default):

-  **WARNING:** The buzzer signal will always remain active when the machine is switched on and off, at the start or end of a washing cycle or in the event of a problem or error with the machine.

- Switch on the dishwasher with the "ON/OFF"  button.
- Keep the "SETUP 5 SEC" button pressed for about 5 sec.
- The "SETTINGS" message appears on the display.
- By pressing the "PROGRAM SELECTION"  key you can select the successive parameters to be adjusted.
- Select the "BUZZER" setting.
- Press the "START/OK" button to confirm the selected parameter.
- Press the "PROGRAM SELECTION"  buttons to choose the two settings: "YES" "NO".
- Confirm your choice by pressing "START/OK".
- If the setting is confirmed, "BUZZER" will appear on the display and will scroll continuously.
- To exit the menu, press the "ON/OFF"  key.

FLOOR LIGHT

While the washing program is running, a floor light is projected onto the floor under the dishwasher door. When the wash cycles are started, the light stays on until the end of the wash cycle. To indicate the end of the wash cycle, the floor light is activated intermittently for 10 sec.

The light is not active when the machine is in the delayed start or pause condition.

The indication will not be visible if the plinth panel is positioned forward or if something is placed in front of the information projector.

AUTO DOOR OPEN (ADO) button

This option activates a special device that opens the door a few centimeters during or at the end of the drying cycle (depending on the programmes), favouring a more natural and efficient drying of the dishes. The duration of the selected cycle will be automatically modified, to allow the rinsing temperatures to be optimised, providing a significant reduction in energy consumption. Opening the door in the last stage of drying enables air to be recirculated, eliminating the risk of unpleasant odours.

The ADO option is automatically activated in the "ECO" program and can be deactivated at any time. Upon first use, the machine will have ADO selected only for the ECO cycle, while it will be deactivated for other cycles. For other washing cycles, simply activate the option using the dedicated button, and it will remain stored until deactivated by repeating the same action. Subsequently, whenever the user changes the ADO setting on a cycle, the machine will store this setting for all cycles until a new change is made.

-  **WARNING:** With this option selected, you must not in any way prevent the door from opening or force it to close, so as not to damage the mechanism. Leave the space in front of the door free and before closing it, wait for the opening device to reactivate.

"NO SALT" warning light

When the "SALT" message appears on the display or, where present, the relative light comes on  fill the tank (see chapter on "ADDING THE SALT").

If the setting level of the softener is set to 0, this will never happen (see chapter on setting the softener).

"NO RINSE AID" warning light

When the "RINSE AID" message appears on the display or, where present, the relative light comes on, fill the tank (see chapter "LOADING RINSE AID").

If the RINSE AID level is set to 0, this will never happen.

DELAY START button

Delay start selection:

This button allows you to programme the start of the wash cycle, with a delay between 0:30 and 24 hours. To set the delayed start proceed as follows:

- Switch on the dishwasher by pressing and holding the "ON/OFF" button for about 3 seconds.
- Select the washing programme.
- Press the "DELAY START" button ("0:30" will appear on the display).
- Press the button again to increase the delay by 30 minutes, after each time the button is pressed it will increase by 1 hour up to a maximum of 24:00. Pressing the button again after a delay of 24:00 will return to 0:00 (delayed start disabled).
- The delayed start settings will remain visible on the display for 5 seconds, or until the ON/OFF - PROGRAM SELECTION - START/OK buttons are pressed.

Changing the programme does not change the delay time and the LED will remain on.

When you press the DELAY START button, the last setting made will be displayed.

Countdown and Programme start with DELAY START

- When the delay is set on a programme: after pressing **"START/OK"**.
- The **"DELAY START"** light stays on until the end of the time.
- The delayed time countdown starts showing on the display **"START IN XX: XX"**.
- The time will be displayed with 30-minute intervals over 24 hours and one-minute intervals over the last 2 hours.
- Pressing any button (except the **"ON/ OFF, START/OK"** buttons for 3 seconds, the programme name **"P XX"** is displayed (P + programme number) for one single scroll and then the delay time is displayed again.

In the event of a power failure or shutdown, the dishwasher stores the time remaining at the start, which will be resumed at the point where it was interrupted once the power supply is restored or the machine is switched on again.

If you want to cancel the delayed start proceed as follows:

- Press and hold the **"START/OK"** button for at least 3 seconds. The display will show **"RESET"** and beeps will sound.
- The delayed start and the selected programme will be cancelled. Two dashes will appear on the display.
- At this point, if you want to start the dishwasher, you will need to set the desired programme again and select the option buttons if necessary.

Water softener

Depending on the source of the supply, water contains varying amounts of limestone and minerals which are deposited on the dishes leaving whitish stains and marks. The higher the level of these minerals present in the water, the harder the water is.

The dishwasher is fitted with a water softener unit which, through the use of special regenerating salt, supplies softened water for washing the dishes. The degree of hardness of your water can be obtained from your water supply company.

Regulating the water softener





The water softener can treat water with a hardness level of up to 90 °fH (French grading) or 50 °dH (German grading) through 8 settings. The settings are listed in the table below, with the relative mains water to be treated.

Level	Water hardness		Use of Regenerating salt	Water softener setting
	°fH (French)	°dH (German)		
0	0-5	0-3	NO	S0
1	6-10	4-6	YES	S1
2	11-20	7-11	YES	S2
3	21-30	12-16	YES	S3
4*	31-40	17-22	YES	S4
5	41-50	23-27	YES	S5
6	51-60	28-33	YES	S6
7	61-90	34-50	YES	S7

* The softener unit is set in the factory at level 4 (S4) as this satisfies the requirements of the majority of users.

Regulate the setting of your water softener unit according to the degree of hardness of your water, as follows:

The dishwasher must ALWAYS be off before start of this procedure.

- Switch on the dishwasher with the "ON/OFF"  button.
- Keep the "SETUP 5 SEC" button pressed for about 5 sec.
- The "SETTINGS" message appears on the display.
- By pressing the "PROGRAM SELECTION"  key you can select the successive parameters to be adjusted.
- Select the "SOFTENER" setting.
- Press the "START/OK" button to confirm the selected parameter.
- The set level appears on the display (the factory-set level is "S4").
- Press the "PROGRAM SELECTION"  buttons to choose different settings levels.
- Confirm your choice by pressing "START/OK".
- "SOFTENER" will scroll on the display.
- To exit the menu, press the "ON/OFF"  key.

To change the water softener setting again, follow the same procedure.

-  **WARNING:** If you cannot complete the procedure, turn the dishwasher off by pressing the "ON/OFF" button and start the procedure again from the beginning (STEP 1).

Information on resin regeneration with salt

The regeneration phase is carried out at the end of a washing cycle.

Approximately 3.5 litres of water are consumed in the resin phase, with an energy consumption of approximately 1Wh and an increase in cycle time of approximately 7 minutes.

For the Eco cycle, it is as shown in the table.

Level	Display	Frequency
S0	DISPLAY S0	Never
S1	DISPLAY S1	1 every 9 cycles
S2	DISPLAY S2	1 every 7 cycles
S3	DISPLAY S3	1 every 5 cycles
S4	DISPLAY S4	1 every 4 cycles
S5	DISPLAY S5	1 every 3 cycles
S6	DISPLAY S6	1 every 2 cycles
S7	DISPLAY S7	Every cycle



Rinse aid

When it becomes necessary to fill the rinse aid container, the display will indicate the lack of rinse aid.

This has been factory-set to level 4, as this satisfies the majority of users.

Adjusting the amount of rinse aid

ALWAYS start the procedure with the dishwasher turned off.

- Switch the appliance on, press "ON/OFF"  button.
- Hold the "setup 5 sec" button, a short beep will sound
- The "SETTINGS" message appears on the display.
- Press the "PROGRAMME SELECTION"  buttons to navigate the submenu.
- Choose the "RINSE AID" option. Press "START/RESET" to access the regulation levels.
- Press "START/OK" to access the regulation levels.

- Press "**PROGRAMME SELECTION**" <> to choose the value (R1 R6). With level R0, no rinse aid is dispensed. (see table)
- Press "**START/OK**" to confirm.
- Press "**ON/OFF**" Ⓛ to confirm.

Rinse aid level (multi dosage)	Meaning
0	No multi dosage and rinse aid detection.
1	1 pulse (1 doses)
2	2 pulse (2 doses)
3	3 pulse (3 doses)
4	4 pulse (4 doses)
5	5 pulse (5 doses)
6	6 pulse (6 doses)

The limestone content of the water considerably affects the formation of limescale and the drying performance.

It is therefore important to regulate the quantity of rinse aid to achieve good washing results.

If, after the wash, there are streaks on the dishes, decrease the amount by one position. If whitish spots occur, increase the amount by one position.

Basket loadability and settings

Adjusting the upper basket

The upper basket is equipped with a height adjustment system.

Lift up:

Lift the basket holding it by the sides (**fig.11**), as soon as it is in the upper position.

Lift down:

Push the lever "A" holding it by the sides (**fig.12**) as soon as it is in the lower position.

- ⚠ **WARNING:** We recommend adjusting the basket before loading the dishes.
- ⚠ **WARNING:** Always accompany the basket during its descent into the stop position.
- ⚠ **WARNING:** Never raise or lower the basket by working on one side only.

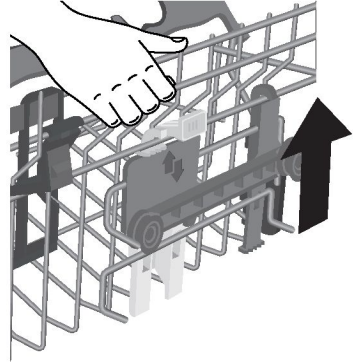

(fig.11)

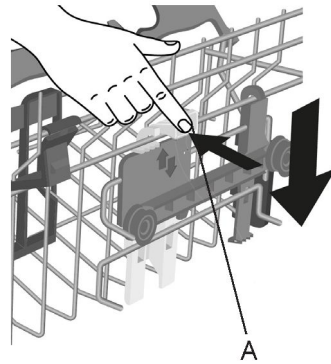

(fig.12)

Loading dishes

Using the upper basket

Cup Holder

The upper basket (**fig.13**) is equipped with movable supports hooked to the side panel. They can either be placed in the open position (**A**) to place tea cups, coffee, long knives and ladles or in the lowered position (**B**) to have more space in the upper basket.

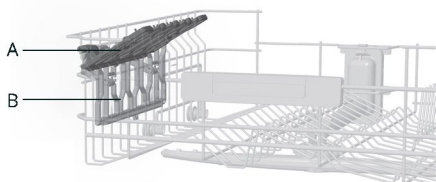

(fig.13)

- Goblet-shaped glasses can be hung on the ends of the supports themselves. (**fig.14**).

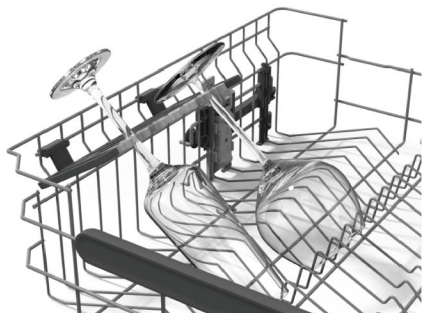

(fig.14)

- The upper basket has been designed to offer maximum flexibility of use. It can be loaded with dessert plates, cups and glasses, which it is advisable to lock to avoid them being overturned by the jets.

- Position the larger plates, slightly inclined towards the front in order to facilitate the easy insertion of the basket inside the machine.

⚠ WARNING: After loading the basket make sure that the spray arm rotates freely without hitting dishes or kitchen utensils.

A standard daily load is represented in (**fig.15**).

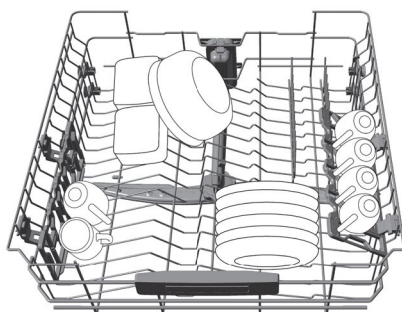

(fig.15)

Using the lower basket

- The lower basket houses pots, pans, tureens, salad bowls, lids, serving plates, dinner plates, and soup plates.
- The cutlery should be placed with the handle down, in the special plastic container positioned in the lower basket making sure that the cutlery itself does not prevent the rotation of the spray arm or the opening of the detergent compartment.

Foldable racks

In the lower basket (**fig.16**), there may be some adjustable combs useful to guarantee optimum stability for the dishes.

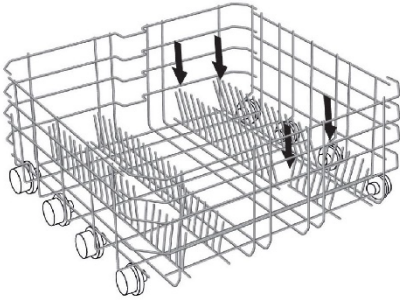

(fig.16)

Non-standard size or shaped dishes or plates can be raised/lowered (fig.17, fig.18 and fig.19) to ensure maximum loading flexibility.

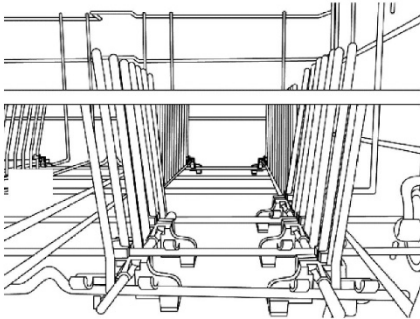

(fig.17)

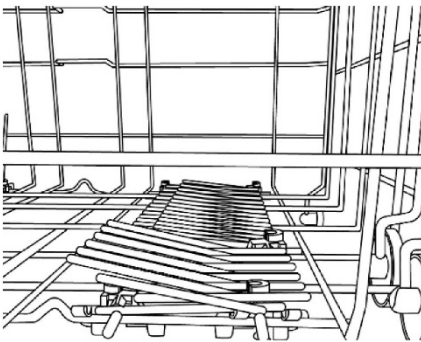

(fig.18)

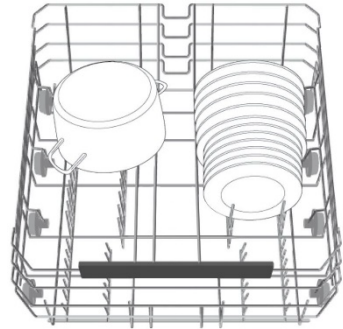

(fig.19)

⚠ WARNING: After loading the basket make sure that the spray arm rotates freely without hitting dishes or kitchen utensils.

Use the third basket to load the cutlery, as shown in the image (fig.20). Load knives with the sharp, cutting side facing downwards.

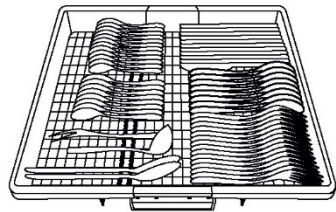

(fig.20)

If necessary, the side shelves of the third basket can be slide or removed (fig.21-22) in order to create additional space in the upper basket for bulky items such as stemware.

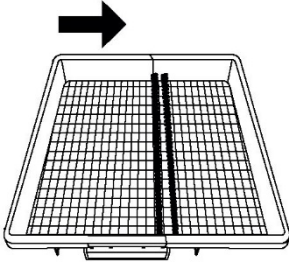

(fig.21)

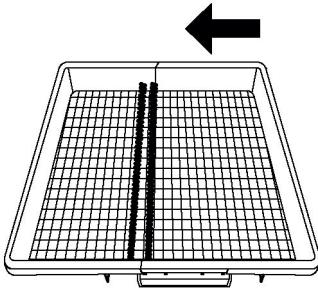

(fig.22)

Power wash

In some programmes (see table of programmes), the third washing arm, positioned at the bottom of the dishwasher **POWER WASH**, will also be enabled. This feature is ideal when cleaning heavily soiled tableware or cookware, placing them directly in the area of the basket above the **POWER WASH** arm.

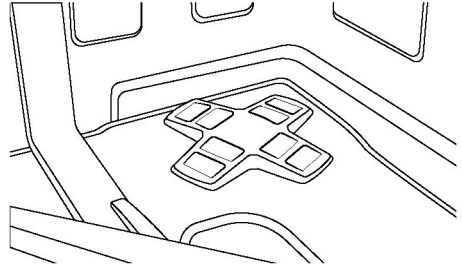

Loading the detergent

Loading the detergent

It is essential to use a detergent that is specifically designed for dishwashers either in powder, liquid, gel or tablet form.

Unsuitable detergents (like those for washing up by hand) do not contain the proper ingredients for use in a dishwasher, and stop the dishwasher from working correctly.

Filling the detergent container

The detergent container is inside the door **(fig.23)**. If container door is closed, to open it simply press the release button **(A)**: the door is always open at the end of any wash programme ready for the next use.

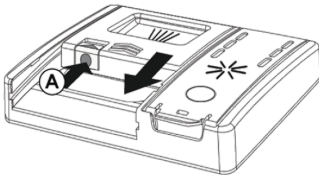

(fig.23)

⚠ WARNING: When loading the lower basket, please ensure that the plates or others do not obstruct the detergent dispenser.

The amount of detergent to be used varies according to how dirty the dishes are and on the type of dishes to be washed. We advise using 20-30 g of detergent in the wash section of detergent compartment **(fig.24)**.

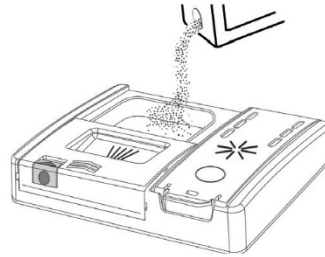

(fig.24)

If you are using tablets, one should suffice. Insert the **TABLETS**, making sure that they do not interfere with the opening system. **(fig.25)**

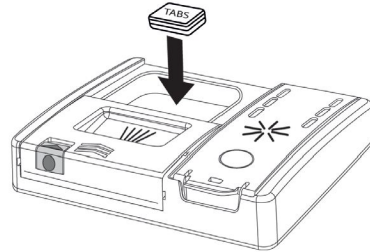

(fig.25)

After pouring the detergent into the container, close the door again, pushing in the direction of the arrow until it clicks into place. **(fig.26)**

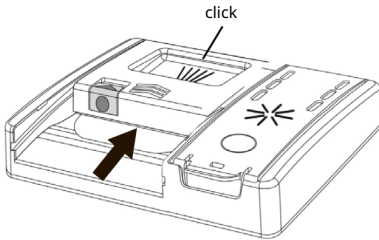

(fig.26)

Since not all detergents are the same the instructions on the boxes of detergent can vary. We should just like to remind users that too little detergent does not clean the dishes properly whilst too much detergent will not produce better results and is also a waste.

Do not use an excessive amount of detergent and help limit damage to the environment at the same time.

Loading pre-wash detergent in programmes that require it

In programmes that have a pre-wash cycle that requires an additional dose of detergent (see the washing programmes chapter), the additional detergent must be poured into the appropriate location (fig.27) C.

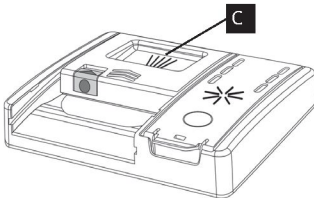

(fig.27)

Types of detergent

Detergent tablets

Detergent tablets of different manufacturers dissolve at different speeds, for this reason, during short programmes, some detergent tablets may be not fully effective, because they are not completely dissolved.

If these products are used, is recommended to choose longer programmes to guarantee the complete use of the detergent.

To get satisfactory washing results, the tablets **MUST** be placed in the wash section of the detergent container and **NOT** directly in the tub.

Concentrated detergents

The concentrated detergents, with reduced alkalinity and with natural enzymes, in conjunction with 50°C wash programmes, have a smaller impact on the environment and they protect the dishes and the dishwasher. The 50°C wash programmes purposely exploit the dirt-dissolving properties of the enzymes, allowing therefore, with the use of the concentrated detergents, to achieve the same results of the 65°C programmes but at a lower temperature.

Combined detergents

The detergents that also contain the rinse aid must be placed in the wash section of the detergent container.

The rinse aid container must be empty (if it is not empty, set the rinse aid regulator to lowest position before using combined detergents).

"TABLETS" combined detergents

If you are planning to use "TABLETS" ("3 in 1" / "4 in 1" / "5 in 1", etc.) combined detergents i.e. those with built in salt and/or rinse agent, we would advise the following:

- read carefully and follow the manufacturer's instructions given on the packaging.

If when using this type of product, you don't get satisfactory washing results, please contact the detergent manufacturer.

In certain circumstances use of combined detergents can cause:

- limescale deposits on dishes or in the dishwasher.
- a reduction in washing and drying performance.

Any problems which arise as a direct result of the use of these products are not covered by our warranty.

If washing and/or drying problems occur, we recommend you return to use traditional separate products (salt, detergent and rinse agent). This will ensure that the water softener in the dishwasher operates correctly.

In this case, we recommends that you:

- refill both the salt and rinse aid container.
- run one normal washing cycle without a load.

Please note that on return to the use of conventional salt, a number of cycles will be required before the system becomes fully efficient again.

Hints and tips

How to get really good wash results

- Before placing the dishes in the dishwasher, remove any remaining food (bones, shells, pieces of meat or vegetables, coffee grounds, skin of fruit, cigarette ash, tooth picks etc. to avoid blocking the filters, water outlet and washing arm nozzles.
- There is no need to rinse the dishes before loading them into the dishwasher, as this leads to increased water and energy consumption and is not recommended.
- If saucepans and oven dishes are encrusted with the remains of burnt or roast food, it is advisable to leave them to soak before washing.
- Place the dishes face downwards.
- Try to place the dishes in such a way that they are not touching one another. If they are loaded properly you will get better results.
- After loading the dishes check that the washing arms can rotate freely.
- Pans and other dishes that have particularly stubborn food particles or remnants of burnt food should be left to soak in water with dishwasher detergent.
- To wash silver properly:
 - rinse the silver immediately after use, especially if it has been used for mayonnaise, eggs, fish etc.
 - do not sprinkle detergent onto it.
 - keep it separate from other metals.

How to make savings.

Tips on how to save money and not damage the environment when using your appliance.

- Achieve the best use of energy, water, detergent and time by using the recommended maximum load size.
- Save up to 50% energy by washing a full load instead of 2 half loads.

- If the dishes are not very dirty or if the baskets are not very full select an **ECO** programme, following the instructions in the program list.
- The most efficient programmes in terms of combined use of water and energy are usually the longer-lasting ones with lower temperature.
- Washing in a dishwasher uses less energy and water compared to hand washing if the dishwasher is used following the manufacturer's instructions and advice.

What not to wash.

- It should be remembered that not all dishes are suitable for washing in a dishwasher. We advise against using the dishwasher to wash items in thermoplastic, cutlery with wooden or plastic handles, saucepans with wooden handles, items in aluminum, crystal leaded glass unless otherwise stated.
- Certain decorations may fade. It is therefore a good idea before loading the whole batch to wash just one of the items first so as to be sure that others like it will not fade.
- It is a good idea not to put silver cutlery with non-stainless steel handles into the dishwasher as there could be a chemical reaction between them.

When buying new crockery or cutlery always make sure that they are suitable for washing in a dishwasher.

Useful hints

- In order to avoid any dripping from the top rack, remove the lower rack first.
- If the dishes are to be left in the machine for some time, leave the door ajar, to let some air circulate and to improve the drying performance.

Cleaning and maintenance

Cleaning the filters

The filter system consists of:

- A central container that traps the larger particles.
 - A micro filter, located beneath the gauze, that traps the tiniest particles ensuring a perfect rinse.
 - A flat gauze that continuously filters the wash water.
- To achieve excellent results every time, the filters should be checked and cleaned after each wash.
 - To remove the filter unit, simply turn the handle anti-clockwise **1** and extract it by pulling it upwards **2** (**fig.28**).

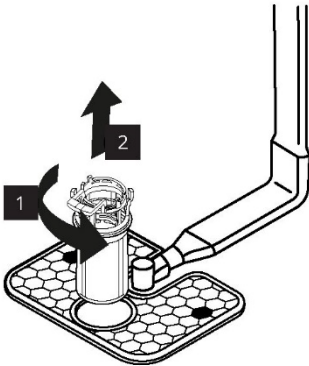

(fig.28)

- For ease of cleaning, the central container is removable (**fig.29**) by pressing the two buttons on the sides and pulling it upwards.

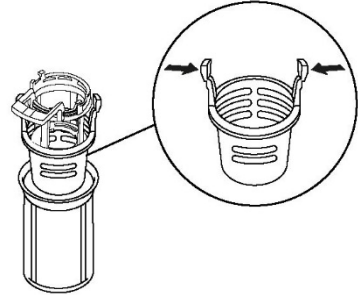

(fig.29)

- Remove the gauze filter (**fig.30**) and wash the whole unit under a jet of water (**fig.31**). If necessary a small brush can be used.

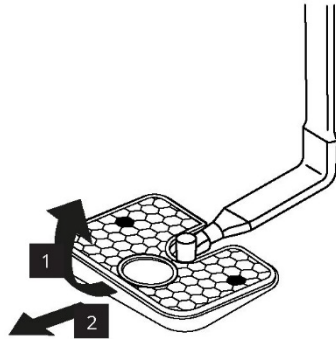

(fig.30)



(fig.31)

- Re-assemble the plate and filter unit by following the previous operations in reverse order, taking care to screw the components back correctly, so as not to jeopardize the operation of the dishwasher.

⚠ ATTENTION: After cleaning the filters, make sure that they are correctly reassembled and that the gauze filter is properly positioned at the bottom of the dishwasher. Make sure that the filter is screwed back, clockwise, into the gauze, as poor seating of the filter unit could have an adverse effect on the efficiency of the appliance.

Never use the dishwasher without the filters.

Cleaning spray arm

Looking after your appliance correctly can extend its lifespan.

Cleaning the appliance's exterior

- Disconnect the machine from the power supply.
- To clean the dishwasher outside, do not use solvents (degreasing action) neither abrasives, but only a cloth soaked with water.

Cleaning the appliance's interior

- The dishwasher does not require special maintenance, because the tank is self-cleaning.
- Regularly wipe the door gasket with a damp cloth to remove any food remains or rinse aid.
- Dishwasher cleaning is recommended, in order to remove limestone deposits or dirt. We suggest you run a washing cycle periodically with specialist dishwasher cleaning products. For all cleaning operations the dishwasher must be empty.
- If, in spite of the routine cleaning of the filters, you notice that the dishes or pans are not properly washed or rinsed, check that all the spray heads on the rotor arms are clear.

If they are blocked, clean them in the following way:

- 1 Remove the upper rotor arm, turning the ring nut from the right to the left (**fig.32**).

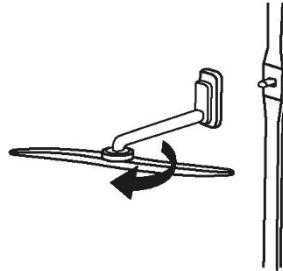

(fig.32)

- 2 The lower rotor arm can be extracted by simply pulling it upwards (**fig.33**).

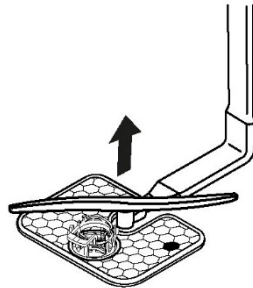

(fig.33)

- 3 Wash the rotor arms under a jet of water to clear any blockage in the spray heads (**fig.34**).



(fig.34)

Do not use tools that can deform the spray heads.

- 4 When you have finished, refit the rotor arms in the same position, remembering to re-align the arrow and screw into position (**fig.35**).

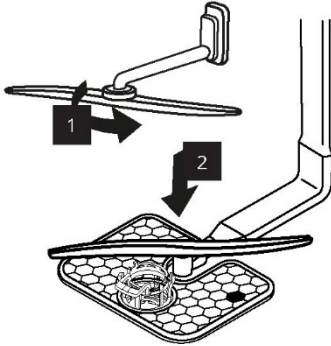

(fig.35)

- 5 Both the door lining and the tank lining are in stainless steel; however, should spots caused by oxidation occur, this is probably due to a high level of iron salts presents in the water.
- 6 The spots can be removed with a mild abrasive agent; never use chlorine based materials, steel wool, etc.

WHEN CYCLE IS FINISHED.

After every wash it is essential to turn off water supply and to switch off the machine by pressing the On/Off button to the off position.

If the machine is not going to be used for some time, it is advisable to follow these rules:

1. Do an empty wash with detergent in order to clean the machine of any deposits
2. Pull out the electric plug
3. Turn off the water tap
4. Fill the rinse aid container
5. Leave the door ajar
6. Keep the inside of the machine clean
7. If the machine is left in places where the temperature is below 0°C any water left inside the pipes may freeze. Wait until the temperature rises above zero and then wait

Troubleshooting

If you believe the dishwasher is not working correctly, consult the quick guide provided below with some practical tips on how to fix the most common problems. If the malfunction continues or recurs, contact the Authorized Service Centre.

BUG REPORTS

Errors are reported by a number preceded by the letter "E" (e.g. Error 2 = E2) and a short audio signal.

Error displayed	Meaning and solutions
<p>"NO WATER" with a short audio signal</p> <p>ERROR E2 with a short audio signal</p>	<p>The dishwasher does not fill with water</p> <ul style="list-style-type: none"> • Make sure the water supply is open. • Make sure the water supply hose is not bent or crushed. • Make sure the drain pipe is at the proper height (see installation section). • Close the water supply, unscrew the drain pipe from the back of the dishwasher and check that the "sand" filter is not clogged.
<p>ERROR E3 with a short audio signal</p>	<p>The dishwasher does not drain water</p> <ul style="list-style-type: none"> • Make sure the drain pipe isn't bent, trapped or blocked, and the filter is not clogged. • Make sure the siphon is not clogged.
<p>ERROR E4 with a short audio signal</p>	<p>Water leak</p> <p>Make sure the drain pipe isn't bent, trapped or blocked, and the filter is not clogged.</p> <p>Make sure the siphon is not clogged.</p>
<p>ERROR E8 with a short audio signal</p>	<p>The water heating element is not working correctly or the filter plate is clogged</p> <p>Clean the filter plate.</p>
<p>ERROR E18 with a short audio signal</p>	<p>Water level problems</p> <p>Check clogged filter plate</p> <p>Clean the filter plate.</p>
<p>ERROR E21 with a short audio signal</p>	<p>Uncontrolled water supply with open solenoid valve. Close the water tap immediately and disconnect the appliance from the power supply.</p>
<p>Any other code</p>	<p>Turn off and unplug the dishwasher, wait a minute. Turn on the machine and restart a program. If the error occurs again contact an Authorized Customer Service Centre directly.</p>

Other faults

FAULTS	CAUSE	SOLUTION
<p>1. No programme works</p>	<p>Plug not connected to wall socket</p>	<p>Connect electric plug</p>
	<p>ON/OFF button not pressed</p>	<p>Press button</p>
	<p>Door is open</p>	<p>Close door</p>
	<p>No electricity</p>	

2. Dishwasher does not fill with water	See point 1	
	The water tap is closed	Open the water tap
	The water supply hose is bent	Eliminate the bends in the hose
	The filter of the water supply hose is clogged	Clean the filter at the end of the hose
3. Dishwasher does not discharge water	Filter is dirty	Clean filter
	Drain pipe is bent	Eliminate the bends in the pipe
	The drain pipe extension is not correctly connected	Follow the instructions for connecting the drain pipe carefully
	The outlet connection on the wall is pointing downwards not upwards	Call a qualified technician
4. Dishwasher discharges water continuously	Position of the drain pipe is too low	Lift drain pipe to at least 40 cm above floor level
5. Spray arms are not heard to rotate	Excessive amount of detergent	Reduce amount of detergent Use suitable detergent
	Item prevents arms from rotating	Reposition the item
	Filtering plate and filter very dirty	Clean filtering plate and filter
6. Dishes only partially washed	See point 5	Check
	Bottom of saucepans have not been washed well	Burnt on food remains must be soaked before putting pans in dishwasher
	Edge of saucepans have not been washed well	Reposition saucepans
	Spray arms are partially blocked	Remove spray arms by unscrewing ring nuts clockwise and wash under running water
	The dishes have not been loaded properly	Do not place the dishes too close together
	The end of the drain pipe is immersed in water	The end of the drain pipe must not come into contact with the outflow water
	An incorrect amount of detergent has been measured out, or the detergent is old and hard	Increase the measure according to how dirty the dishes are, or change detergent

	The cap of the salt container is not closed properly	Choose a more vigorous programme
	The wash programme is not thorough enough	Tighten it properly
7. Detergent not dispensed or partially dispensed	Cutlery, dishes, pans, etc. stop the detergent dispenser from opening	Position dishes so as not to obstruct the dispenser
8. Presence of white spots on dishes	Mains water is too hard	Check salt and rinse aid level and regulate. Should the fault persist, contact the Authorized Service Centre
9. Noise during wash	The dishes knock against one another	Re-check loading of dishes in the basket
	The revolving arms knock against the dishes	Re-check loading of dishes in the basket
10. The dishes are not completely dry	Inadequate air flow	Leave the dishwasher door ajar at the end of the wash program to allow the dishes to dry naturally
	Rinse aid missing	Fill the rinse aid dispenser

Please note: Should any of the above situations result in a bad wash performance or insufficient rinsing, remove dirt deposits from the dishes by hand since the final drying cycle hardens the dirt, making it difficult to remove with a subsequent wash.

If the malfunction continues, contact the Authorized Service Centre, quoting the model of the dishwasher. This is found on the plate on the upper section of the inside of the dishwasher door, or on the warranty. This information will make it possible to take quicker, more effective action.

Environmental concerns



This appliance is marked according to the European directive 2012/19/EU on Waste Electrical and Electronic Equipment (WEEE). WEEE contains both polluting substances (which can cause negative consequences for the environment) and basic components (which can be re-used).

It is important to have WEEE subjected to specific treatments, in order to remove and dispose properly all pollutants, and recover and recycle all materials. Individuals can play an important role in ensuring that WEEE does

not become an environmental issue; it is essential to follow some basic rules:

- WEEE should not be treated as household waste;
- WEEE should be handed over to the relevant collection points managed by the municipality or by registered companies. In many countries, for large WEEE, home collection could be present.

In many countries, when you buy a new appliance, the old one may be returned to the retailer who has to collect it free of charge on a one-to-one basis, as long as the equipment is of equivalent type and has the same functions as the supplied equipment.

IKEA guarantee

How long is the IKEA guarantee valid?

This guarantee is valid for five (5) years from the original date of purchase of your appliance at IKEA or from the installation date with maximum limit of three months from the purchase date. The original sales receipt, is required as proof of purchase. If service work is carried out under guarantee, this will not extend the guarantee period for the appliance. Once a warranted product has been replaced, the replaced product warranty will be valid for the balance period from date of original purchase invoice.

Who will execute the service?

IKEA service provider will provide the service through its own service operations or authorized service partner network.

What does this guarantee cover?

- The guarantee covers faults of the appliance, which have been caused by faulty construction or material faults from the date of purchase from IKEA or from the installation date with maximum limit of three months from the purchase date.

- This guarantee applies to domestic use only.
- The exceptions are specified under the headline "What is not covered under this guarantee?" Within the guarantee period.
- The costs to remedy the fault e.g. repairs, parts, labour and travel will be covered, provided that the appliance is accessible for repair without special expenditure. On these conditions the respective local regulations are applicable.
- Replaced parts become the property of IKEA.
- In case of non-repairable product, the retail value of the replacement will not exceed the purchase price that was paid by the customer

What will IKEA do to correct the problem?

- IKEA appointed Service Provider will examine the product and decide, at its sole discretion, if it is covered under this guarantee. If considered covered, IKEA Service Provider or its authorized service partner through its own service operations, will then, at its sole discretion, either repair the defective product or

replace it with the same or a comparable product.

What is not covered under this guarantee?

- Normal wear and tear.
- Deliberate or negligent damage, damage caused by failure to observe operating instructions, incorrect installation or by connection to the wrong voltage, damage caused by chemical or electro-chemical reaction, rust, corrosion or water damage including but not limited to damage caused by excessive lime in the water supply, damage caused by abnormal environmental conditions.
- Consumable parts including batteries and lamps.
- Non-functional and decorative parts which do not affect normal use of the appliance, including any scratches and possible colour differences.
- Accidental damage caused by foreign objects or substances and cleaning or unblocking of filters, drainage systems or soap drawers.
- Damage to the following parts: ceramic glass, accessories, crockery and cutlery baskets, feed and drainage pipes, seals, lamps and lamp covers, screens, knobs, casings and parts of casings. Unless such damages can be proved to have been caused by production faults.
- Cases where no fault could be found during a technician's visit.
- Repairs not carried out by our appointed service providers and/or an authorized service contractual partner or where non-original parts have been used.
- Repairs caused by installation which is faulty or not according to specification.
- The use of the appliance in a nondomestic environment i.e. professional use.
- Damage resulting from power outage, power surges or dips, fluctuating voltage or improper voltage All workout parts are not covered by the guarantee e.g.: filters and cleanliness.
- Transportation damages. If a customer transports the product to his home or another address, IKEA is not liable for any damage that may occur during transport. However, if IKEA delivers the product to the customer's delivery address, then damage to the product that occurs during this delivery will be covered by IKEA.
- Cost for carrying out the initial installation of the IKEA appliance. However, if an IKEA service provider or its authorized service partner repairs or replaces the appliance under the terms of this guarantee, the service provider or its authorized service partner will re-install the repaired appliance or install the replacement, if necessary.
- All plumbing and electrical installation, are not the responsibility of IKEA, and customer must complete these work before the execution work.

How country law applies

The IKEA guarantee gives you specific legal rights, which covers or exceed local demands. However these conditions do not limit in any way consumer rights described in the local legislation.

Area of validity

This warranty is valid only in the country where the product has been purchased; the services will be provided in the framework of the guarantee conditions.

An obligation to carry out services in the framework of the guarantee exists only if the appliance complies and is installed in accordance with:

- the technical specifications of the country in which the guarantee claim is made;
- the Assembly Instructions and User Manual Safety Information;

The dedicated After Sales Service for IKEA appliances:

Please don't hesitate to contact IKEA appointed After Sales Service Provider to:

- make a service request under this guarantee;
- ask for clarifications on installation of the IKEA appliance in the dedicated IKEA kitchen furniture;
- ask for clarification on functions of IKEA appliances.

To ensure that we provide you with the best assistance, please read carefully the Assembly Instructions and/or the User Manual before contacting us.

How to reach us if you need our service



Please refer to the last page of this manual for the full list of IKEA appointed contacts and relative national phone numbers.

- ① In order to provide you with a quicker service, we recommend that you use the specific phone numbers listed at the end of this manual. Always refer to the numbers listed in the booklet of the specific appliance you need an assistance for. Before calling us, assure that you have to hand the IKEA article number (8 digit code) and the Serial Number (16 digit code that can be found on the rating plate) for the appliance of which you need our assistance.

- ① **SAVE THE SALES RECEIPT!** It is your proof of purchase and required for the guarantee to apply. The sales receipt also reports the IKEA name and article number (8 digit code) for each of the appliances you have purchased.



UNITED ARAB EMIRATES & OMAN

Toll free: 8 004 532
Web: www.IKEA.com

QATAR

Toll free: 8 004 532
Web: www.IKEA.qa
e-mail: Ikea_qatar@alfuttaim.com

EGYPT

Hotline: 16576
Web: www.IKEA.eg
e-mail: IkeaCairo.customerservice@alfuttaim.com

STATE OF KUWAIT

Contact centre: +965 18 40 40 8
Web: www.IKEA.com.kw
e-mail: info@IKEA.com.kw

JORDAN

Contact centre: +962 6 400 1000
Web: www.IKEA.jo

KINGDOM OF SAUDI ARABIA

Contact centre: 92000-4532
Our phone lines are open:
Saturday - Thursday 09:00 AM - 10:00 PM
Friday 2:00 PM - 10:00 PM

BAHRAIN

Contact centre: 80001120
Our telephone lines are open all day 09:00 AM - 10:00 PM

