

# FABJERG

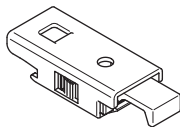

2x

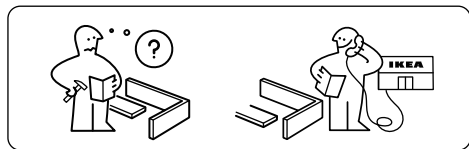
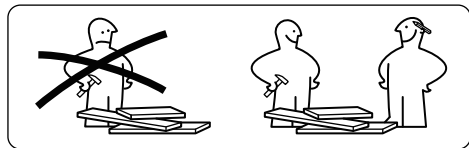
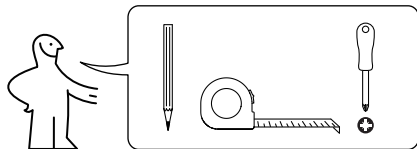
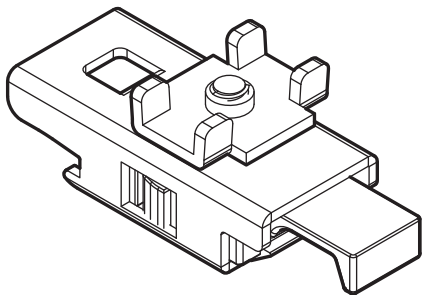
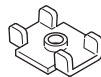

2x



2x

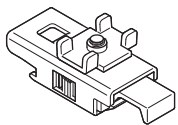

+

**i**

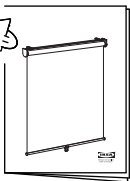

**1**

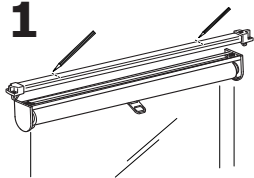

**2**

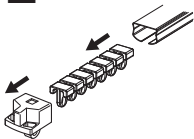

**3**

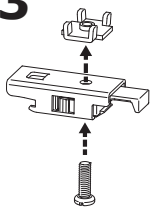

**4**

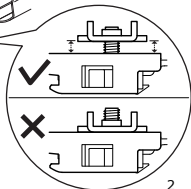
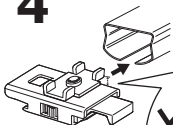

2

**5**

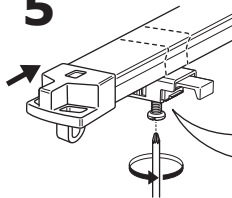

✓

✗

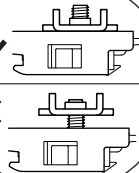

**6**

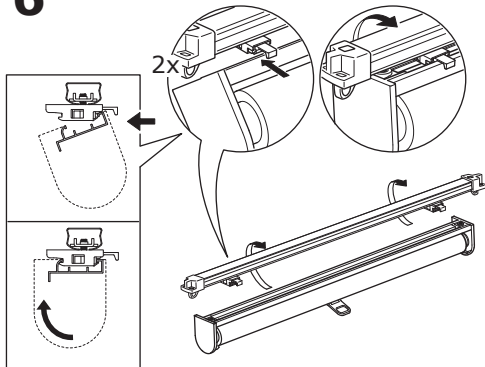

3