

LAGAN

en



Design and Quality
IKEA of Sweden



For the IKEA appointed Authorized Service Centre, please refer to the IKEA catalogue or **www.IKEA.com** and select your local store for phone numbers and opening times.

Table of contents

Safety Information	5	Cleaning and maintenance	12
Product description	7	What to do if ...	13
Control panel	7	After-Sales Service	14
First Use	7	Technical Data	15
Loading the racks	9	Environmental concerns	15
Daily Use	10	Installation	16
Programs table	11	IKEA GUARANTEE	17

Safety Information

Before using the appliance, read these safety instructions. Keep them nearby for future reference.

These instructions and the appliance itself provide important safety warnings, to be observed at all times. The manufacturer declines any liability for failure to observe these safety instructions, for inappropriate use of the appliance or incorrect setting of controls.

⚠ Very young children (0-3 years) should be kept away from the appliance. Young children (3-8 years) should be kept away from the appliance unless continuously supervised. Children from 8 years old and above and persons with reduced physical, sensory or mental capabilities or lack of experience and knowledge can use this appliance only if they are supervised or have been given instructions on safe use and understand the hazards involved. Children must not play with the appliance. Cleaning and user maintenance must not be carried out by children without supervision.

PERMITTED USE

⚠ CAUTION: the appliance is not intended to be operated by means of an external switching device, such as a timer, or separate remote controlled system.

⚠ This appliance is intended to be used in household and similar applications such as: staff kitchen areas in shops, offices and other working environments; farm houses; by clients in hotels, motels, bed & breakfast and other residential environments.

⚠ This appliance is not for professional use. Do not use the appliance outdoors.

⚠ The maximum number of place settings is shown in the product sheet.

⚠ The door should not be left in the open position - risk of tripping. The open appliance door can only support the

weight of the loaded rack when pulled out. Do not rest objects on the door or sit or stand on it.

⚠ WARNING: Dishwasher detergents are strongly alkaline. They can be extremely dangerous if swallowed. Avoid contact with the skin and eyes and keep children away from the dishwasher when the door is open. Check that the detergent receptacle is empty after completion of the wash cycle.

⚠ WARNING: Knives and other utensils with sharp points must be loaded in the basket with their points down or placed in a horizontal position - risk of cuts.

⚠ Do not store explosive or flammable substances (e.g. gasoline or aerosol cans) inside or near the appliance - risk of fire. The appliance must be used only to wash domestic dishes in accordance with the instructions in this manual. The water in the appliance is not potable. Use only detergent and rinse additives designed for an automatic dishwasher. When adding a water softener (salt), run one cycle immediately with the machine empty, to avoid corrosion damage to internal parts. Store the detergent, rinse aid and salt out of reach of children. Shut off the water supply and unplug or disconnect the power before servicing and maintenance. Disconnect the water and electricity supply in the event of any malfunction.

INSTALLATION

⚠ The appliance must be handled and installed by two or more persons - risk of injury. Use protective gloves to unpack and install - risk of cuts.

⚠ Installation, including water supply (if any), electrical connections and repairs must be carried out by a qualified technician. Do not repair or replace any part of the appliance unless specifically stated in the user manual. Keep children

away from the installation site. After unpacking the appliance, make sure that it has not been damaged during transport. In the event of problems, contact the dealer or your nearest After-sales Service. Once installed, packaging waste (plastic, styrofoam parts etc.) must be stored out of reach of children - risk of suffocation.

The appliance must be disconnected from the power supply before any installation operation - risk of electrical shock. During installation, make sure the appliance does not damage the power cable - risk of fire or electrical shock. Only activate the appliance when the installation has been completed. Connect the dishwasher to the water mains using only new hose sets. The old hose sets should not be reused. All hoses must be securely clamped to prevent them coming loose during operation.

All local waterboard regulations must be complied with.

Water supply pressure 0.05 - 1.0 MPa.

The appliance must be placed against the wall or built into furniture to limit the access to its rearside.

For dishwashers having ventilation openings in the base, the openings must not be obstructed by a carpet.

If installing the dishwasher at the end of a row of units making the side panel accessible, the hinge area must be covered to avoid risk of injury.

The inlet water temperature depends on the dishwasher model. If the installed inlet hose is marked "25°C Max", the maximum allowed water temperature is 25°C. For all other models the maximum allowed water temperature is 60°C. Do not cut hoses and, in the case of appliances fitted with a waterstop system, do not immerse the plastic casing containing the inlet hose in water. If hoses are not long enough, contact your local dealer. Make sure the inlet and drain hoses are kink-free and are not crushed. Before using the appliance for the first time, check the water inlet and drain hose for leaks. Make sure that the four feet are stable and resting on the floor, adjusting them as required, and check that the dishwasher is perfectly levelled using a spirit level.

⚠ Use the appliance only when the covers shown on diagram 19 in the Assembly instruction are correctly assembled - risk of injury.

ELECTRICAL WARNINGS

The rating plate is on the edge of the dishwasher door (visible when the door is open).

ⓘ Valid for India only: In order to prevent damage of the product, please use the voltage stabilizer.

⚠ It must be possible to disconnect the appliance from the power supply by unplugging it if plug is accessible, or by a multi-pole switch installed upstream of the socket in accordance with the wiring rules and the appliance must be earthed in conformity with national electrical safety standards.

⚠ Do not use extension leads, multiple sockets or adapters. The electrical components must not be accessible to the user after installation. Do not use the appliance when you are wet or barefoot. Do not operate this appliance if it has a damaged power cable or plug, if it is not working properly, or if it has been damaged or dropped.

⚠ If the supply cord is damaged, it must be replaced with an identical one by the manufacturer, its service agent or similarly qualified persons in order to avoid a hazard - risk of electrical shock.

If the fitted plug is not suitable for your socket outlet, contact a qualified technician. Do not pull the power supply cable. Do not immerse the mains cord or plug in water. Keep the cord away from hot surfaces.

CLEANING AND MAINTENANCE

⚠ WARNING: Ensure that the appliance is switched off and disconnected from the power supply before performing any maintenance operation. To avoid risk of personal injury use protective gloves (risk of laceration) and safety shoes (risk of contusion); be sure to handle by two persons (reduce load); never use steam cleaning equipment (risk of electric shock). Non-professional repairs not authorized by the manufacturer could result in a risk to health and safety, for which the manufacturer cannot be held liable. Any defect or damage caused from nonprofessional repairs or maintenance will not be covered by the guarantee, the terms of which are outlined in the document delivered with the unit.

Product description

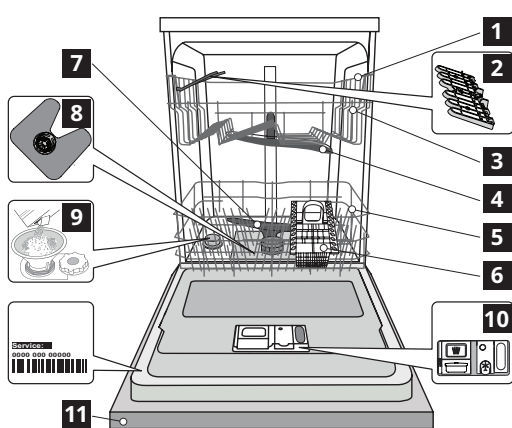

- 1 Upper rack
- 2 Foldable flaps
- 3 Upper rack height adjuster
- 4 Upper sprayer arm
- 5 Lower rack
- 6 Cutlery basket
- 7 Lower sprayer arm
- 8 Filter Assembly
- 9 Salt reservoir
- 10 Detergent and Rinse Aid dispensers
- 11 Control panel

Control panel

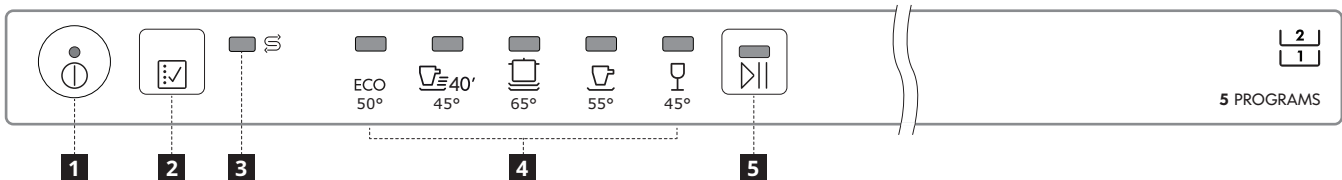

- 1 On-Off/Reset button with indicator light
- 2 Program selection button
- 3 Salt refill indicator light
- 4 Program indicator lights
- 5 START/Pause button with indicator light

First Use

Advice regarding the first time use

Before installation and first usage of the appliance please read carefully „ SAFETY INSTRUCTION“ and „ASSEMBLY INSTRUCTION“ available in the product literature bag. Please remember to remove all transport protection parts from the dishwasher.

Filling the salt reservoir

The use of salt prevents the formation of LIMESCALE on the dishes and on the machine's functional components.

- It is mandatory that **THE SALT RESERVOIR BE NEVER EMPTY.**
- It is important to set the water hardness.

The salt reservoir is located in the lower part of the dishwasher (see PRODUCT DESCRIPTION) and should be filled when the SALT REFILL indicator light in the control panel is lit.

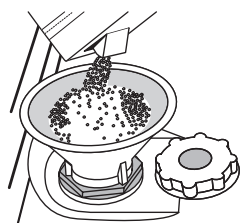

1. Remove the lower rack and unscrew the reservoir cap (anticlockwise).
2. Position the funnel (see figure) and fill the salt reservoir right up to its edge (approximately 1 kg); it is not unusual for a little water to leak out.
3. **Only the first time you do this: fill the salt reservoir with water.**
4. Remove the funnel and wipe any salt residue away from the opening.

Make sure the cap is screwed on tightly, so that no detergent can get into the container during the wash program (this could damage the water softener beyond repair).

As soon as this procedure is complete, run a program without loading. The "Pre-Wash" program alone is NOT sufficient. Residual saline solution or grains of salt can lead to corrosion, irreparably damaging the stainless steel components. The guarantee is not applicable if faults are caused by such circumstances.

Only use salt that has been specifically designed for dishwashers. If the salt container is not filled, the water softener and the heating element may be damaged as a result of limescale accumulation. Using of Salt is recommended with any type of dishwasher detergent. Whenever you need to add salt, it is mandatory to complete the procedure before the beginning of the washing cycle to avoid corrosion.

Setting the water hardness

To allow the water softener to work in a perfect way, it is essential that the water hardness setting is based on the actual water hardness in your house. This information can be obtained from your local water supplier. The factory sets the default value for the water hardness.

- Switch on the appliance by pressing the ON/OFF button.
- Switch off the appliance by pressing the ON/OFF button.
- Hold down button [] for 5 seconds, until you hear a beep.
- Switch on the appliance by pressing quickly the ON/OFF button.
- The program indicator light of the current set level flashes.
- Press button [] to select the desired hardness level (see WATER HARDNESS TABLE).
- Switch off the appliance by pressing the ON/OFF button.

Setting is complete!

Water Hardness Table			
Level	°dH German degrees	°fH French degrees	°Clark English degrees
1 Soft	0 - 6	0 - 10	0 - 7
2 Medium	7 - 11	11 - 20	8 - 14
3 Average	12 - 16	21 - 29	15 - 20
4 Hard	17 - 34	30 - 60	21 - 42
5 Very hard	35 - 50	61 - 90	43 - 62

Water Softening System

Water softener automatically reduces water hardness, consequently preventing scale buildup on heater, contributing also to better cleaning efficiency. This system regenerates itself with salt, therefore it is required to refill salt container when empty. Frequency of regeneration depends on water hardness level setting - regeneration takes place once per 6 Eco cycles with water hardness level set to 3.

Regeneration process starts in final rinse and finishes in drying phase, before cycle ends.

- Single regeneration consumes: ~3.5 L of water;
- Takes up to 5 additional minutes for the cycle;
- Consumes below 0.005 kWh of energy.

Filling the rinse aid dispenser

Rinse aid makes dish DRYING easier. The rinse aid dispenser **A** should be filled when when the dark optical indicator on the dispenser door **C** becomes transparent.

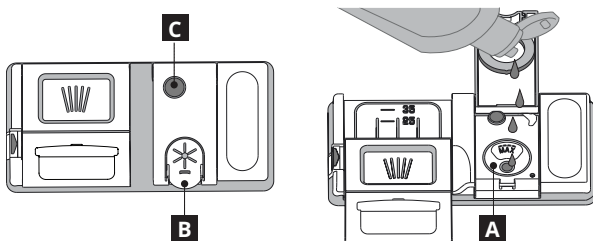

1. Open the dispenser **B** by pressing and pulling up the tab on the lid.
2. Carefully introduce the rinse aid as far as the maximum (110 ml) reference notch of the filling space - avoid spilling it. If this happens, clean the spill immediately with a dry cloth.
3. Press the lid down until you hear a click to close it.

NEVER pour the rinse aid directly into the tub.

Adjusting the dosage of rinse aid

If you are not completely satisfied with the drying results, you can adjust the quantity of rinse aid used.

- Switch the dishwasher on using the ON/OFF button.
- Switch it off using the ON/OFF button.
- Press button [] three times - a beep will be heard.
- Switch it on using the ON/OFF button.
- The program indicator light of the current set level flashes.
- Press button [] to select the level of rinse aid quantity to be supplied.
- Switch it off using the ON/OFF button.

Setting is complete!

If the rinse aid level is set to 1 (ECO), no rinse aid will be supplied. The LOW RINSE AID indicator light will not be lit if you run out of rinse aid. A maximum of 5 levels can be set according to the dishwasher model. The factory setting is specific to the model, please follow instruction above to check this for your machine.

- If you see bluish streaks on the dishes, set a low number (2-3).
- If there are drops of water or limescale marks on the dishes, set a high number (4-5).

Filling the detergent dispenser

Usage of detergent not designed for dishwashers may cause malfunction or damage to the appliance.

To achieve the best washing and drying results, the combined use of detergent, rinse aid liquid and refined salt is required. We recommend using detergents that do not contain phosphates or chlorine, as these products are harmful to the environment.

Good washing results also depend on the correct amount of detergent being used.

Exceeding the stated amount does not result in a more effective wash and increases environmental pollution.

The amount can be adjusted to the soil level. In the case of normally soiled items, use approximately either 35g (powder detergent) or 35ml (liquid detergent) and additional tea spoon of detergent directly inside the tub. If tablets are used, one tablet will be enough.

If the crockery is only lightly soiled or if it has been rinsed with water before being placed in the dishwasher, reduce the amount of detergent used accordingly (minimum 25 g/ml) e.g. skip the powder/gel putted inside the tub.

To open the detergent dispenser press button **D. Introduce the detergent into the dry dispenser **E** only. Place the amount of detergent for pre-washing directly inside the tub.**

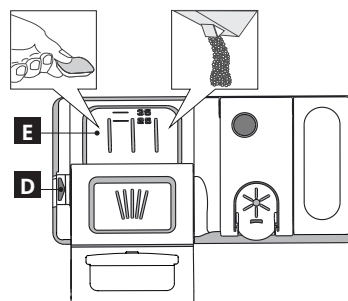

1. When measuring out the detergent refer to the mentioned earlier information to add the proper quantity. Inside the dispenser **E** there are indications to help the detergent dosing.
2. Remove detergent residues from the edges of the dispenser and close the cover until it clicks.
3. Close the lid of the detergent dispenser by pulling it up until the closing device is secured in place.

The detergent dispenser automatically opens up at the right time according to the program.

Loading the racks

TIPS

Before loading the baskets, remove all food residues from the crockery and empty the glasses. You do not need to rinse beforehand under running water.

Arrange the crockery so that it is held in place firmly and does not tip over; and arrange the containers with the openings facing downwards and the concave/convex parts placed obliquely, thus allowing the water to reach every surface and flow freely.

Warning: lids, handles, trays and frying pans do not prevent the sprayer arms from rotating.

Place any small items in the cutlery basket. Very soiled dishes and pans should be placed in the lower basket because in this sector the water sprays are stronger and allow a higher washing performance.

After loading the appliance, make sure that the sprayer arms can rotate freely.

Upper rack

Load delicate and light dishes: glasses, cups, saucers, low salad bowls.

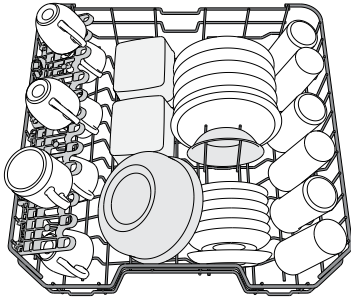

(loading example for the upper rack)

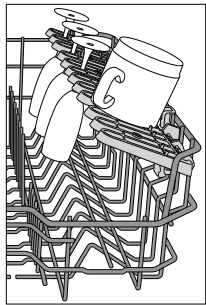

Foldable flaps with adjustable position

The side foldable flaps can be fold or unfold to optimize the arrangement of crockery inside the rack.

Wine glasses can be placed safely in the foldable flaps by inserting the stem of each glass into the corresponding slots. Depending on the model:

- to unfold the flaps there is needed to slide it up and rotate or release it from the snaps and pull it down.
- to fold the flaps there is needed to rotate it and slide flaps down or pull it up and attach flaps to the snaps.

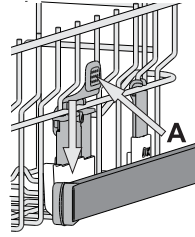
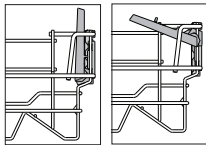

Adjusting the height of the upper rack

The height of the upper rack can be adjusted: high position to place bulky crockery in the lower basket and low position to make the most of the tip-up supports by creating more space upwards and avoid collision with the items loaded into lower rack.

The upper rack is equipped with a **Upper Rack height adjuster** (see figure), without pressing the levers, lift it up by simply holding the rack sides, as soon as the rack is stable in its upper position.

To restore to the lower position, press the levers **A** at the sides of the rack and move the basket downwards.

We strongly recommend that you do not adjust the height of the rack when it is loaded.

NEVER raise or lower the basket on one side only.

Lower rack

For pots, lids, plates, salad bowls, cutlery etc. Large plates and lids should ideally be placed at the sides to avoid interferences with the spray arm.

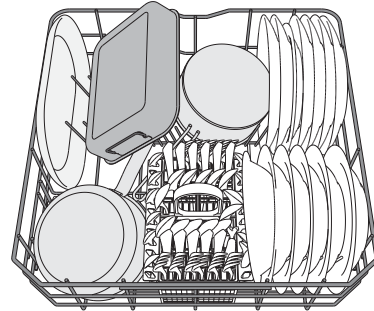

(loading example for the lower rack)

Cutlery basket

The basket is equipped with top grilles for improved cutlery arrangement. The cutlery basket should be positioned only at the front of the lower rack.

Knives and other utensils with sharp edges must be placed in the cutlery basket with the points facing downwards or they must be positioned horizontally in the tip-up compartments on the upper rack.

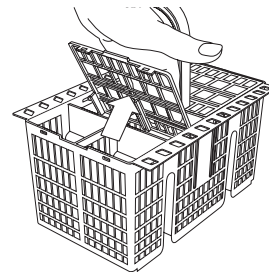

Unsuitable crockery

- Wooden crockery and cutlery.
- Delicate decorated glasses, artistic handicraft and antique crockery. Their decorations are not resistant.
- Parts in synthetic material which do not withstand high temperatures.
- Copper and tin crockery.
- Crockery soiled with ash, wax, lubricating grease or ink.

The colours of glass decorations and aluminium/silver pieces can change and fade during the washing process. Some types of glass (e.g. crystal objects) can become opaque after a number of wash cycles too.

Damage to glass and crockery

- Only use glasses and porcelain guaranteed by the manufacturer as dishwasher safe.
- Use a delicate detergent suitable for crockery
- Collect glasses and cutlery from the dishwasher as soon as the wash cycle is over.

Hygiene

To avoid odour and sediment which can be accumulated in the dishwasher please run a high temperature program at least once a month. Use a tea spoon of detergent and run it without the loading to clean your appliance.

TIPS ON ENERGY SAVING

- When the household dishwasher is used according to the manufacturer's instructions, **washing tableware in a dishwasher usually consumes less energy and water than hand dishwashing.**
- In order to maximize dishwasher efficiency it is recommended to **initiate the wash cycle once dishwasher is fully loaded.** Loading the household dishwasher up to the capacity indicated by the manufacturer will contribute to energy and water savings. Information on correct loading of tableware can be found in Loading chapter. Incorrect loading or overloading the dishwasher may increase resources usage (such as water, energy and time, as well as increase noise level), reducing cleaning and drying performance.
- Manual pre-rinsing of tableware items leads to increased water and energy consumption and is not recommended.

Daily Use**1. CHECK WATER CONNECTION**

Check that the dishwasher is connected to the water supply and that the tap is open.

2. SWITCH ON THE DISHWASHER

Open the door and press the ON/OFF button.

3. LOAD THE RACKS (see LOADING THE RACKS)**4. FILLING THE DETERGENT DISPENSER**

(see FILLING THE DETERGENT DISPENSER).

5. CHOOSE THE PROGRAM AND CUSTOMISE THE CYCLE

Select the most appropriate program in accordance with the type of crockery and its soiling level (see PROGRAMS DESCRIPTION) by pressing the  button.

6. START

Start the wash cycle by pressing START/Pause button (led is lit) and closing the door within 4 sec. When the program starts you hear a single beep. If the door was not closed within 4sec., the alarm sound will be played. In this case, open the door, press START/Pause button and close the door again within 4 sec.

7. END OF WASH CYCLE

The end of the wash cycle is indicated by beeps and by the flashing of the indicator light of the selected program. Open the door and switch off the appliance by pressing the ON/OFF button.

Wait for a few minutes before removing the crockery - to avoid burns. Unload the racks, beginning with the lower one.

The machine will switch off automatically during certain extended periods of inactivity, in order to minimise electricity consumption. If the crockery is only lightly soiled or if it has been rinsed with water before being placed in the dishwasher, reduce the amount of detergent used accordingly.

Modifying a running program

If a wrong program was selected, it is possible to change it, provided that it has only just begun: open the door, press and hold the ON/OFF button, the machine will switch off. Switch the machine back on using the ON/OFF button and select the new wash cycle; Start the wash cycle by pressing START/Pause button and closing the door within 4 sec.

If it takes more than 4 seconds the appliance automatically pauses and you must restart the appliance again by repeating the last operation.





Adding extra crockery

Without switching off the machine, open the door (START/Pause led starts blinking) (**be aware of HOT steam!**) and place the crockery inside the dishwasher. Press the START/Pause button and close the door within 4 sec., the cycle will resume from the point at which it was interrupted.

Accidental interruptions

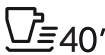
If the door is opened during the wash cycle, or if there is a power cut, the cycle pauses. Press the START/Pause button and close the door within 4 sec., the cycle will resume from the point at which it was interrupted.

Programs table

Program			Drying phase	Duration of wash program (h:min)*	Water consumption (litres/cycle)	Energy consumption (kWh/cycle)
1 Eco	ECO	50°	✓	3:35	9.5	0.95
2 Fast Wash 40'	 40'	45°	-	0:40	9.0	0.50
3 Intensive		65°	✓	2:40	18.0	1.60
4 Mixed		55°	✓	2:15	16.0	1.40
5 Glass		45°	✓	1:40	11.5	1.20

ECO program data is measured under laboratory conditions according to European Standard EN 60436:2020.

Note for Test Laboratories: For information on comparative EN testing conditions, please send an email to the following address:

dw_test_support@whirlpool.com

Pre-treatment of the dishes is not needed before any of the programs.

*) Values given for programmes other than the eco program are indicative only. The actual time may vary depending on many factors such as temperature and pressure of the incoming water, room temperature, amount of detergent, quantity and type of load, load balancing, additional selected options and sensor calibration.

- 1. ECO** - Eco program is suitable to clean normally soiled tableware, that for this use, it is the most efficient program in terms of its combined energy and water consumption, and that it is used to assess compliance with the EU Ecodesign legislation.
- 2. FAST WASH 40'** - Program for limited quantity of normally soiled crockery. Ensures optimal cleaning performance in shorter time.
- 3. INTENSIVE** - Program recommended for heavily soiled crockery, especially suitable for pans and saucepans (not to be used for delicate items).
- 4. MIXED** - Mixed soil. For normally soiled dishes with dried food residues.
- 5. GLASS** - Program for delicate items, which are more sensitive to high temperatures, for example glasses and cups.

Cleaning and maintenance

ATTENTION: Always unplug the appliance when cleaning it and when performing maintenance work. Do not use flammable liquids to clean the machine.

Cleaning the dishwasher

Any marks on the inside of the appliance may be removed using a cloth dampened with water and a little vinegar.

The external surfaces of the machine and the control panel can be cleaned using a non-abrasive cloth which has been dampened with water. Do not use solvents or abrasive products.



Preventing unpleasant odours

Always keep the door of the appliance ajar in order to avoid moisture from forming and being trapped inside the machine. Clean the seals around the door and detergent dispensers regularly using a damp sponge. This will avoid food becoming trapped in the seals, which is the main cause behind the formation of unpleasant odours.

Checking the water supply hose

Check the inlet hose regularly for brittleness and cracks. If damaged, replace it by a new hose available through our After-Sales Service or your specialist dealer. Depending on the hose type:

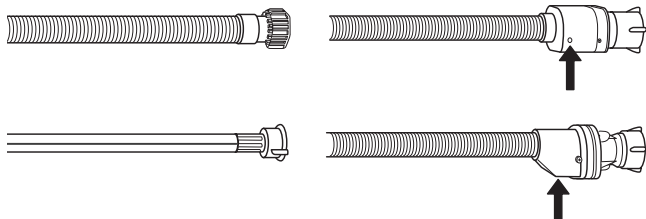

If the inlet hose has a transparent coating, periodically check if the colour intensifies locally. If yes, the hose may have a leak and should be replaced.

For water stop hoses: check the small safety valve inspection window (see arrow). If it is red, the water stop function was triggered, and the hose must be replaced by a new one.

For unscrewing this hose, press the release button while unscrewing the hose.

Cleaning the water inlet hose

If the water hoses are new or have not been used for an extended period of time, let the water run to make sure it is clear and free of impurities before performing the necessary connections. If this precaution is not taken, the water inlet could become blocked and damage the dishwasher.

Cleaning the filter assembly

Regularly clean the filter assembly so that the filters do not clog and that the waste water flows away correctly. Using dishwasher with clogged filters or foreign objects inside filtration system or sprayarms may cause unit malfunction resulting in loss of performance, noisy work or higher resources usage. The filter assembly consists of three filters which remove food residues from the washing water and then recirculate the water. **The dishwasher must not be used without filters or if the filter is loose.**

At least once per month or after each 30 cycles, check the filter assembly and if necessary clean it thoroughly under running water, using a non-metallic brush and following the instructions below:

1. Turn the cylindrical filter **A** in an anti-clockwise direction and pull it out (Fig 1).
2. Remove the cup filter **B** by exerting a slight pressure on the side flaps (Fig 2).
3. Slide out the stainless-steel plate filter **C** (Fig 3).
4. In case you find foreign objects (such as broken glass, porcelain, bones, fruit seeds etc.) **please remove them carefully.**
5. Inspect the trap and remove any food residues. **NEVER REMOVE** the wash-cycle pump protection (black detail) (Fig 4).

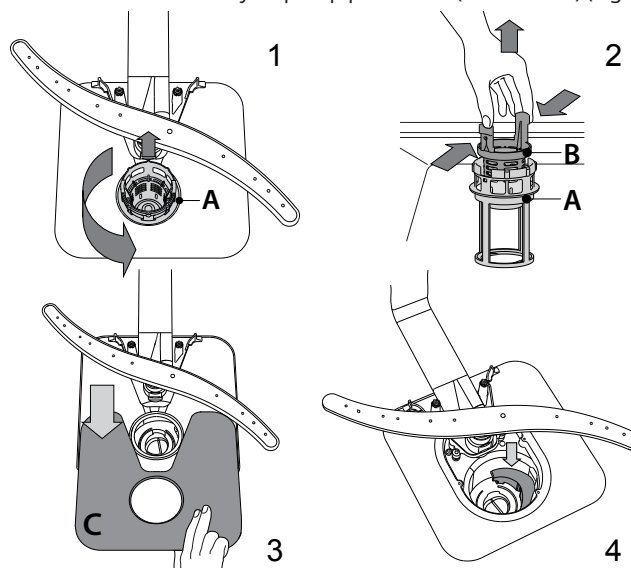

After cleaning the filters, replace the filter assembly and fix it in position correctly; this is essential for maintaining the efficient operation of the dishwasher.

Cleaning the spray arms

On occasions, food residue may become encrusted onto the spray arms and block the holes used to spray the water. It is therefore recommended that you check the arms from time to time and clean them with a small non-metallic brush.

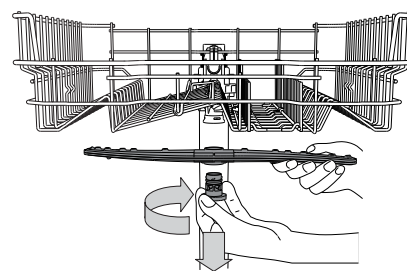

To remove the upper spray arm, turn the plastic locking ring in a clockwise direction. The upper spray arm should be replaced so that the side with the greater number of holes is facing upwards.

The lower spray arm may be removed by pulling it upwards and rotating it anti-clockwise.

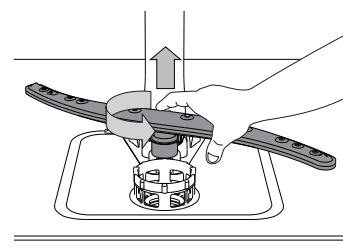

What to do if ...



In case your dishwasher doesn't work properly, check if the problem can be solved by going through the following list. For other errors or issues please contact authorized After-sales Service which contact details can be found in the guarantee booklet. Spare parts will be available for a period of either up to 7 or up to 10 years, according to the specific Regulation requirements.

The spare parts can be found: <https://parts-selfservice.whirlpool.com/en/landing>

Problems...	Possible causes...	Solutions...
 Salt indicator is lit	Salt reservoir is empty. (After refill the salt indicator may remain lit for several wash cycles).	Refill reservoir with salt (for more information - see page 7). Adjust water hardness - see table, page 8.
The dishwasher won't start or does not respond to commands.	The appliance has not been plugged in properly.	Insert the plug into the socket.
	Power outage.	For safety reasons, dishwasher will not re-start automatically when power returns. Open dishwasher door, press START/Pause button and close the door within 4 seconds.
	The dishwasher door is not closed.	Vigorously push the door until you hear the "click".
	Cycle is interrupted by door opening for more than 4 seconds.	Press START/Pause and close the door within 4 seconds.
	It does not respond to commands.	Switch off the appliance by pressing the ON/OFF button, switch it back on after approximately one minute and restart the program. If problem persists, unplug the appliance for 1 minute, then plug it back in.
The dishwasher won't drain.	The wash cycle has not finished yet.	Wait until the wash cycle finishes.
	The drain hose is bent.	Check that the drain hose is not bent (see INSTALLATION).
	The sink drain pipe is blocked.	Clean the sink drain pipe.
	The filter is clogged up with food residues.	Clean the filter (see CLEANING THE FILTER ASSEMBLY).
The dishwasher makes excessive noise.	The dishes are rattling against each	Position the crockery correctly (see LOADING THE RACKS).
	An excessive amount of foam has been produced.	The detergent has not been measured out correctly or it is not suitable for use in dishwashers (see FILLING THE DETERGENT DISPENSER). Restart the current cycle by switching OFF the dishwasher, then switch it on again, select a new program, press START/Pause and close the door within 4 seconds. Please do not add any detergent.
The dishes are not clean.	The crockery has not been arranged properly.	Arrange the crockery correctly (see LOADING THE RACKS).
	The spray arms cannot rotate freely, being hindered by the dishes.	Arrange the crockery correctly (see LOADING THE RACKS).
	The wash cycle is too gentle and/or detergent efficiency is low.	Select an appropriate wash cycle (see PROGRAMS TABLE).
	An excessive amount of foam has been produced.	The detergent has not been measured out correctly or it is not suitable for use in dishwashers (see FILLING THE DETERGENT DISPENSER).
	The cap on the rinse aid compartment has not been shut correctly.	Make sure the cap of the rinse aid dispenser is closed.
	The filter is soiled or clogged.	Clean the filter assembly (see CLEANING AND MAINTENANCE).
	There is no salt.	Fill the salt reservoir (see FILLING THE SALT RESERVOIR).
Dishwasher finishes the cycle prematurely.	Drain hose positioned too low or siphoning into home sewage system.	Check if end of drain hose is placed at correct height (see INSTALLATION). Check for siphoning into home sewage system, install air admittance valve if necessary.
	Air in water supply.	Check water supply for leaks or other issues letting air inside.
The dishwasher does not fill the water. All LEDs are blinking rapidly	No water in the water supply or the tap is closed.	Make sure there is water in the water supply or the tap running.
	The inlet hose is bent.	Make sure the inlet hose is not bent (see INSTALLATION) reprogram the dishwasher and reboot.
	The sieve in the water inlet hose is clogged; it is necessary to clean it	After having carried out the verification and cleaning, turn off and turn on the dishwasher and restart a new program.

Problems...	Possible causes...	Solutions...
Dishes have not been dried.	Selected program has no drying phase.	Verify in the programs table if the selected program has drying phase.
	Rinse aid has run out or the dosage is not adequate.	Add the rinse aid or adjust the dosage levels higher (see FILLING THE RINSE AID DISPENSER).
	Dishes are made of non-stick or plastic.	The presence of drops of water it is normal (see TIPS).
Dishes and glasses show limescale or a whitish film.	Salt level is too low.	Fill the salt reservoir (see FILLING THE SALT RESERVOIR).
	Adjustment of the water hardness is not adequate.	Increase the values (see WATER HARDNESS TABLE).
	Cap of the salt reservoir is not properly closed.	Check the salt reservoir cap.
	Rinse aid has run out or the dosage is insufficient.	Add the rinse aid or adjust the dosage levels higher.
Dishes and glasses have a bluish tinge or blue streaks.	Rinse aid dosage is excessive.	Adjust the dosage rates to lower values.

After-Sales Service

If, after carrying out the above checks, the fault persists, disconnect the mains plug and turn off the water tap. Contact the After-sales Service (see guarantee).

Before contacting our After-Sales Service, take note of the following:

- the description of the fault,
- the appliance type and model,

- the service code (the number indicated on the adhesive rating plate) inside the door on the right-hand side:



Technical Data

Product dimensions (mm)	Height	mm	820
	Width	mm	598
	Depth	mm	555
Performances	Voltage	V	220-240
	Frequency	Hz	50
	Energy efficiency class		E
	Cleaning performance index		1.13
	Drying performance index		1.07
	Water supply pressure, max	Bar	10
	Water supply pressure, min	Bar	0.5
	Energy consumption	kWh/100 cycles	95
	Water supply, max inlet water temp.	°C	60
	Number of place settings		14
	Power consumption in delay start	W	4
	Power consumption in standby mode	W	0.5
	Water consumption	l/cycle	9.5
	Noise level	dB(A) re 1 pW	46
Noise class		C	

*) Performance data is measured under laboratory conditions according to European Standard EN 60436:2020/A12 and (EU) 2019/2017 regulation.

Environmental concerns

Disposal of packaging materials

The packaging material is 100% recyclable and is marked with the recycle symbol . The various parts of the packaging must therefore be disposed of responsibly and in full compliance with local authority regulations governing waste disposal.

Disposal of household appliances

This appliance is manufactured with recyclable or reusable materials. Dispose of it in accordance with local waste disposal regulations. For further information on the treatment, recovery and recycling of household electrical appliances, contact your local authority, the collection service for household waste or the store where you purchased the appliance. This appliance is marked in compliance with European Directive 2012/19/EU, Waste Electrical and Electronic Equipment (WEEE) and with the Waste Electrical and Electronic Equipment regulations 2013 (as amended). By ensuring this product is disposed of correctly, you will help prevent negative consequences for the environment and human health.

The symbol  on the product or on the accompanying documentation indicates that it should not be treated as domestic waste but must be taken to an appropriate collection center for the recycling of electrical and electronic equipment.

Energy saving tips

ECO programme is suitable to clean normally soiled tableware, that for this use, it is the most efficient programme in terms of its combined energy and water consumption, and that it is used to assess compliance with the EU Ecodesign legislation. Loading the household dishwasher up to the capacity indicated by the manufacturer will contribute to energy and water savings. The manual pre-rinsing of tableware items leads to increased water and energy consumption and is not recommended. Washing tableware in a household dishwasher usually consumes less energy and water in the use phase than hand dishwashing when the household dishwasher is used according to the manufacturer's instructions.

Installation

ATTENTION: If the appliance must be moved at any time, keep it in an upright position; if absolutely necessary, it may be tilted onto its back.

Connecting the water supply

Adaptation of the water supply for installation should only be performed by a qualified technician. The water inlet and outlet hoses may be positioned towards the right or the left in order to achieve the best possible installation. Make sure the dishwasher does not bend or squash the hoses.

Connecting the water inlet hose

- Run the water until it is perfectly clear.
 - Screw the inlet hose tightly into position and turn on the tap. If the inlet hose is not long enough, contact a specialist store or an authorised technician.
- The water pressure must be within the values indicated in the Technical Data table - otherwise the dishwasher may be function properly. Make sure the hose is not bent or compressed.

Specifications for the connection of the water supply hose:

Water supply	cold or hot (max. 60°C)
Water intake	3/4"
Power of water pressure	0.05 ÷ 1 MPa (0.5 ÷ 10 bar) 7.25 – 145 psi

Connecting the water outlet hose

Connect the outlet hose to a drain duct with a minimum diameter of 2 cm **A**.

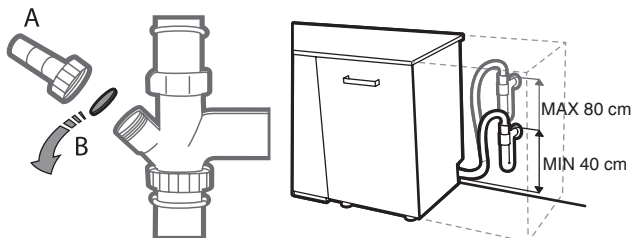

The outlet hose connection must be at a height ranging from 40 to 80 cm from the floor or surface where the dishwasher rests. Before connecting the water outlet hose to the sink drain, remove the plastic plug **B**.

Electrical connection

⚡ WARNING: Under no circumstances should the water inlet hose be cut as it contains live electrical parts.

Before inserting the plug into the electrical socket, make sure that:

- The socket is **earth** and complies with current regulations;
- The socket can withstand the maximum load of the appliance as shown on the data plate located on the inside of the door (see PRODUCT DESCRIPTION).
- The power supply voltage falls within the values indicated on the data plate on the inside of the door.
- The socket is compatible with the plug of the appliance.

If this is not the case, ask an authorised service only to replace the certified power cord with a correct plug dedicated for this appliance (see AFTER-SALES SERVICE). Do not use extension cables or multiple sockets or not authorized power cords with plugs. Once the appliance has been installed, the power supply cable and the electrical socket should be easily accessible.

The cable should not be bent or compressed. If the power supply cable is damaged, have it replaced by the manufacturer or its authorised Technical Assistance Service in order to prevent all potential hazards. The Company shall not be held responsible for any incidents, if these regulations are not observed.

Positioning and levelling

1. Position the dishwasher on a level sturdy floor. If the floor is uneven, the front feet of the appliance may be adjusted until it reaches a horizontal position. If the appliance is levelled correctly, it will be more stable and much less likely to move or cause vibrations and noise while it is operating.
2. Before recessing the dishwasher, stick the adhesive transparent strip under the wooden shelf in order to protect it from any condensation which may form.
3. Place the dishwasher so that its sides or back panel are in contact with the adjacent cabinets or the wall. This appliance can also be recessed under a single worktop.
4. To adjust the height of the rear foot, turn the red hexagonal bushing on the lower central part at the front of the dishwasher using a hexagonal spanner with an opening of 8 mm. Turn the spanner in a clockwise direction to increase the height and in an anticlockwise direction to decrease it.

DIMENSIONS AND CAPACITY:

Width	598 mm
Height	820 mm
Depth	555 mm
Capacity	14 standard place-settings

IKEA GUARANTEE

How long is the IKEA guarantee valid?

This guarantee is valid for **five (5) years** from the original date of purchase of your appliance at IKEA. The original sales receipt is required as proof of purchase. If service work is carried out under guarantee, it will not extend the guarantee period for the appliance.

Which LAGAN appliances are not covered by the IKEA 5-year guarantee?

LAGAN appliances purchased from IKEA before 1 May 2026 are covered by a 2-year guarantee, starting from the original date of purchase.

What does this guarantee cover?

The guarantee covers faults of the appliance, which have been caused by faulty construction or material faults from the date of purchase from IKEA. This guarantee applies to domestic use only. The exceptions are specified under the headline "What is not covered under this guarantee?" Within the guarantee period, the costs to remedy the fault e.g. repairs, parts, labour and travel will be covered, provided that the appliance is accessible for repair without special expenditure. On these conditions the respective local regulations are applicable. Replaced parts become the property of IKEA.

What will IKEA do to correct the problem?

IKEA appointed Service Provider will examine the product and decide, at its sole discretion, if it is covered under this guarantee. If considered covered, IKEA Service Provider or its authorized service partner through its own service operations, will then, at its sole discretion, either repair the defective product or replace it with the same or a comparable product.

What is not covered under this guarantee?

- Normal wear and tear.
- Deliberate or negligent damage, damage caused by failure to observe operating instructions, incorrect installation or by connection to the wrong voltage, damage caused by chemical or electro-chemical reaction, rust, corrosion or water damage including but not limited to damage caused by excessive lime in the water supply, damage caused by abnormal environmental conditions.
- Consumable parts including batteries and lamps.
- Non-functional and decorative parts which do not affect normal use of the appliance, including any scratches and possible color differences.
- Accidental damage caused by foreign objects or substances and cleaning or unblocking of filters, drainage systems or soap drawers.
- Damage to the following parts: ceramic glass, accessories, crockery and cutlery baskets, feed and drainage pipes, seals, lamps and lamp covers, screens, knobs, casings and parts of casings. Unless such damages can be proved to have been caused by production faults.
- Cases where no fault could be found during a technician's visit.
- Repairs not carried out by our appointed service providers and/or an authorized service contractual partner or where nonoriginal parts have been used.
- Repairs caused by installation which is faulty or not according to specification.
- The use of the appliance in a nondomestic environment i.e. professional use.
- Transportation damages. If a customer transports the product to his home or another address, IKEA is not liable for any damage that may occur during transport. However, if IKEA delivers the product to the customer's delivery address, then damage to the product that occurs during this delivery will be covered by IKEA.
- Cost for carrying out the initial installation of the IKEA appliance.

- However, if an IKEA appointed Service Provider or its authorized service partner repairs or replaces the appliance under the terms of this guarantee, the appointed Service Provider or its authorized service partner will reinstall the repaired appliance or install the replacement, if necessary.
- All plumbing and electrical installation, are not the responsibility of IKEA, and customer must complete these work before the execution work.

How country law applies

The IKEA guarantee gives you specific legal rights, which cover or exceed all the local legal demands. However these conditions do not limit in any way consumer rights described in the local legislation.

Valid for INDIA only: The courts at New Dehli have exclusive jurisdiction for setting the claims or disputes or matters arising out of present Warranty.

Area of validity

This warranty is valid only in the country where the product has been purchased; the services will be provided in the framework of the guarantee conditions.

An obligation to carry out services in the framework of the guarantee exists only if the appliance complies and is installed in accordance with:

- the technical specifications of the country in which the guarantee claim is made;
- the Assembly Instructions and User Manual Safety Information;

The dedicated AFTER SALES for IKEA appliances

Please don't hesitate to contact IKEA appointed Authorized Service Centre to:

- make a service request under this guarantee;
- ask for clarifications on installation of the IKEA appliance in the dedicated IKEA kitchen furniture;
- ask for clarification on functions of IKEA appliances.

To ensure that we provide you with the best assistance, please read carefully the Assembly Instructions and/or the User Manual before contacting us.

How to reach us if you need our service



- The IKEA after sales customer service centre will assist you on the phone with basic troubleshooting for your appliances at the time of service call request. Please refer to **www.IKEA.com** and select your local store for local store phone numbers and opening times.

- **Before calling us, assure that You have to hand the IKEA article number (8 digit code) and the Serial Number (12 digit code that can be found on the rating plate) for the appliance of which you need our assistance.**

SAVE THE SALES RECEIPT!

- It is your proof of purchase and required for the guarantee to apply. Note that the receipt reports also the IKEA article name and number (8 digit code) for each of the appliances you have purchased.

Do you need extra help?

For any additional questions not related to After Sales of your appliances please contact your nearest IKEA store call centre. We recommend you read the appliance documentation carefully before contacting us.

400020041501

