

# SOLARVET

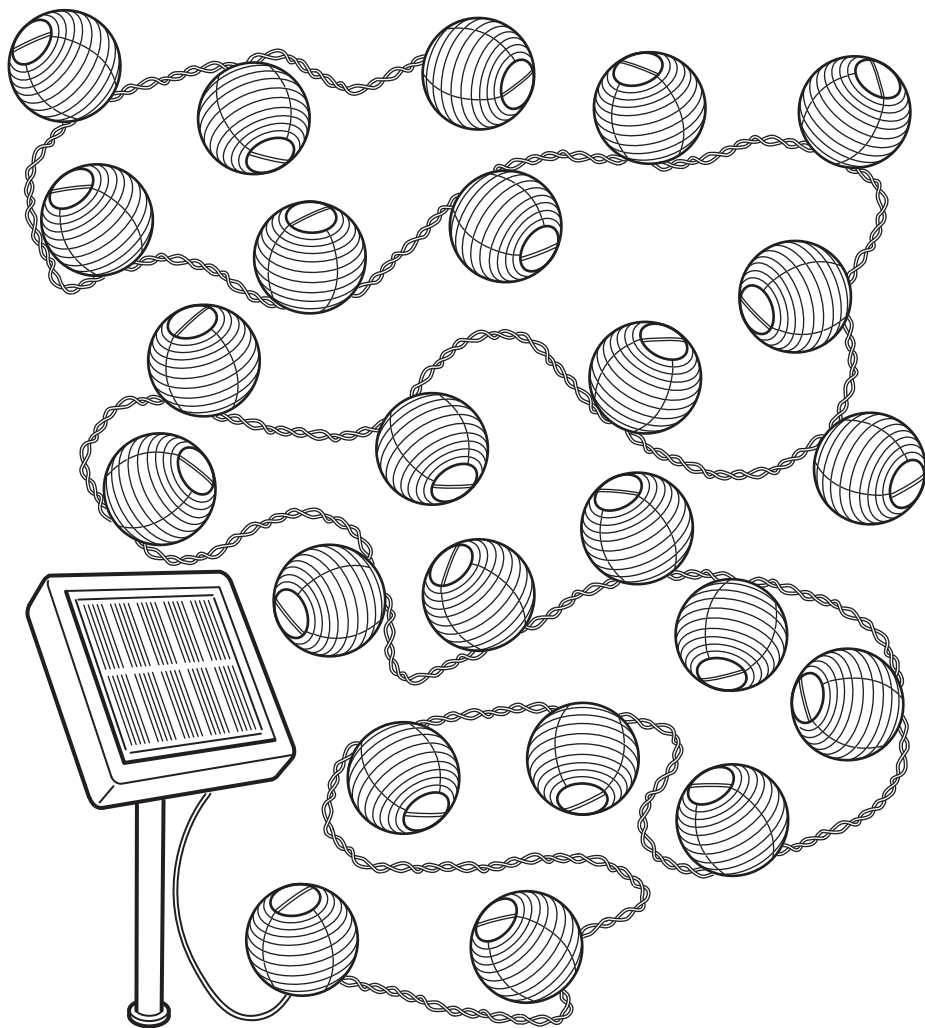

Design and Quality  
IKEA of Sweden



**English**

CAUTION! Strangulation hazard.  
Hang out of reach of young children.

**עברית**

אזהרה! סכנת חנק. תלו הרחק מהישג ידם של ילדים.

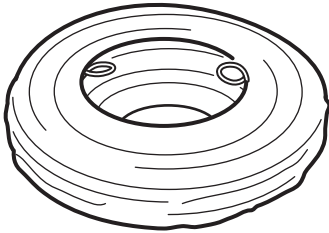
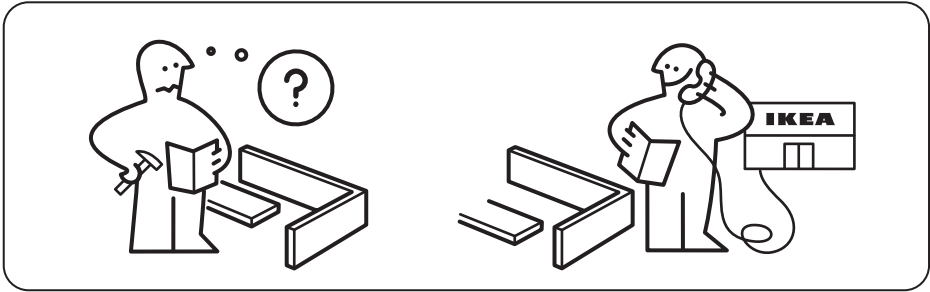

24x

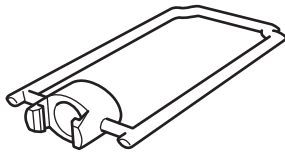

24x



1x

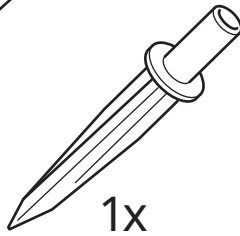
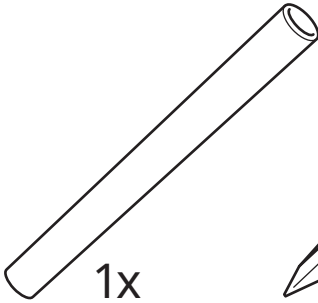
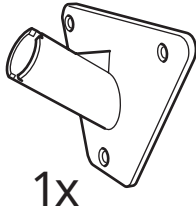
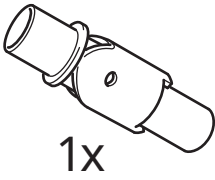
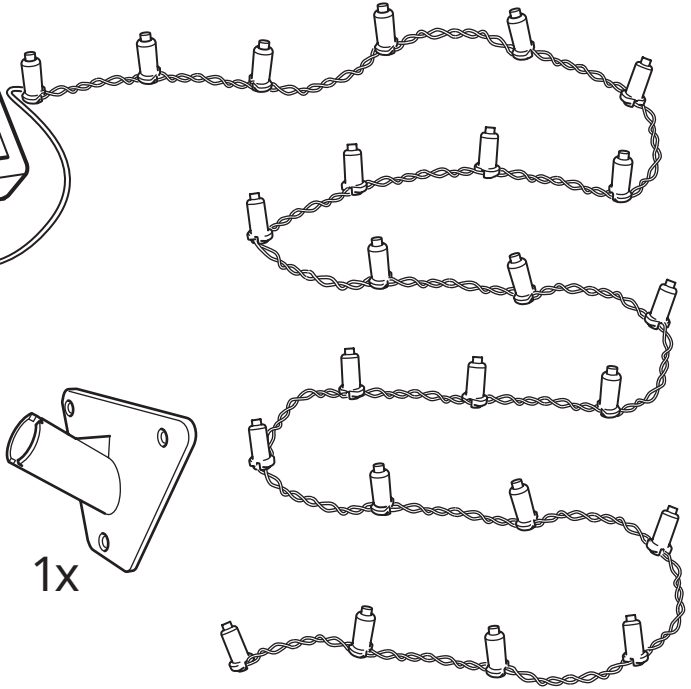
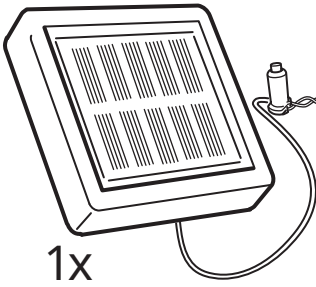

1

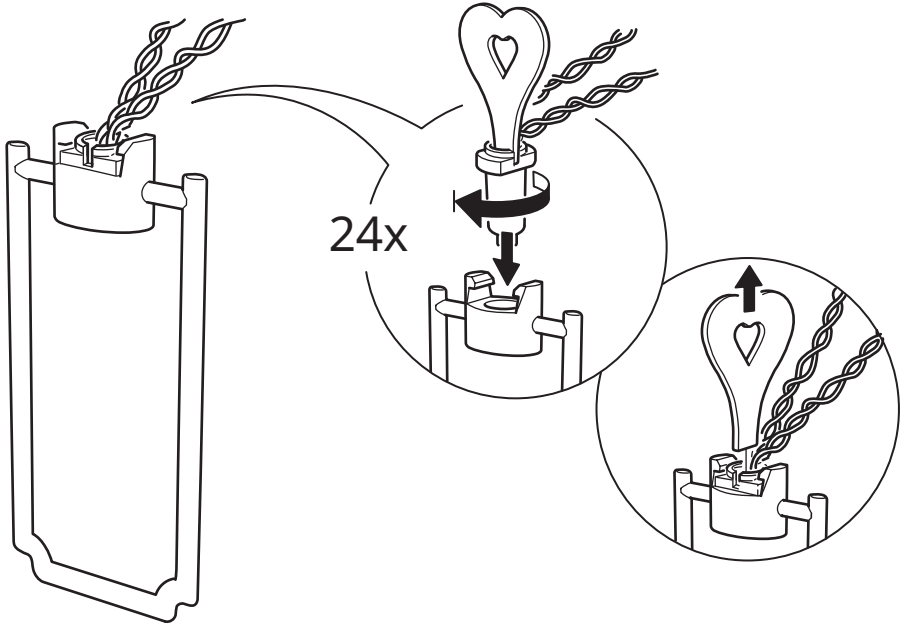

2

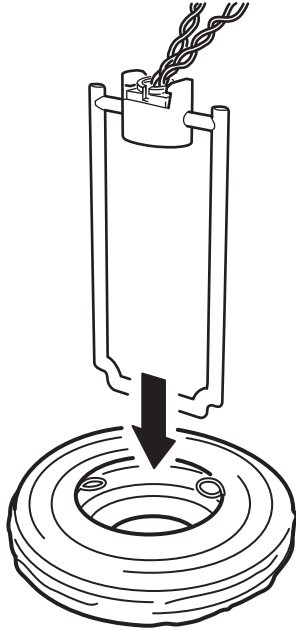

3

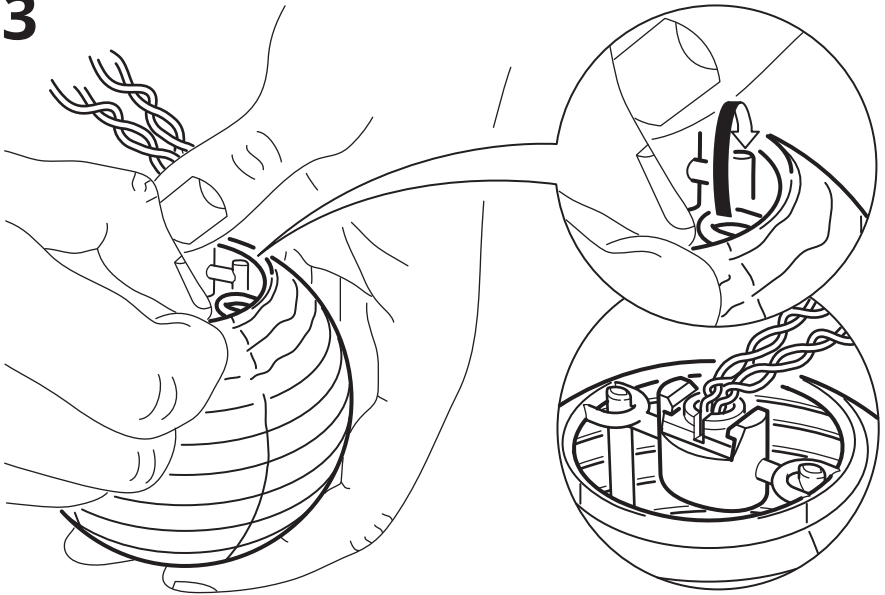

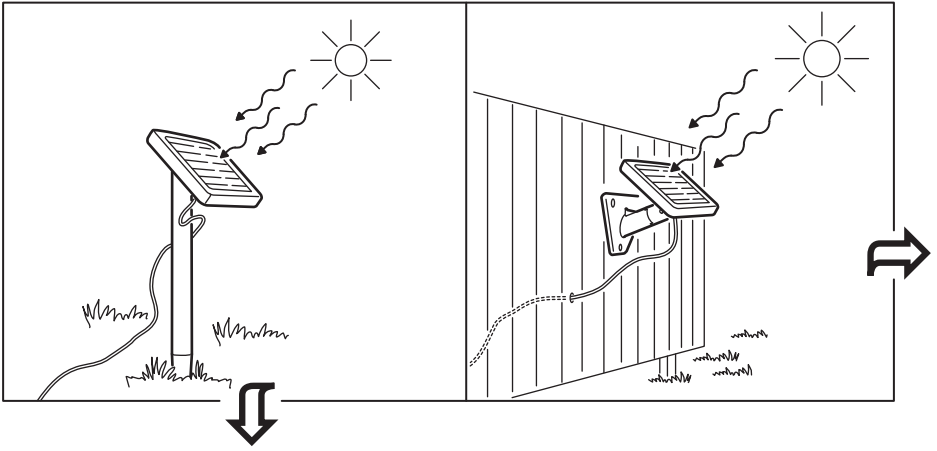

4

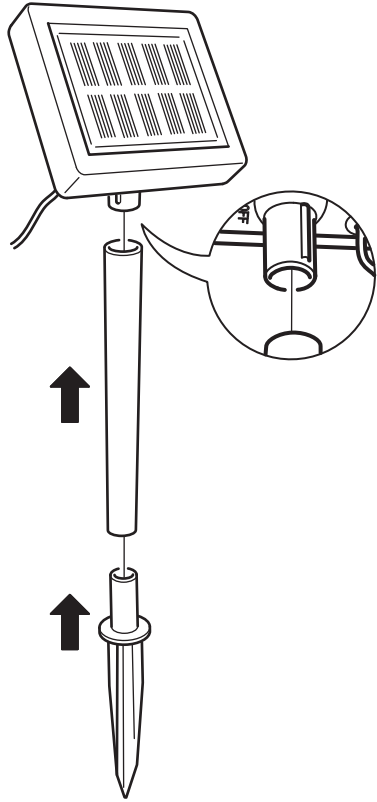

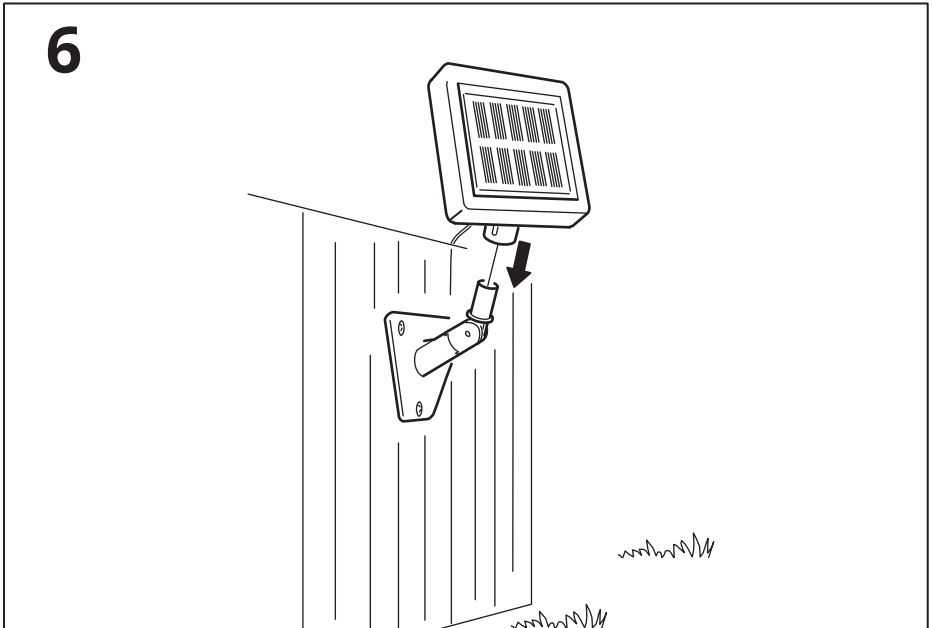
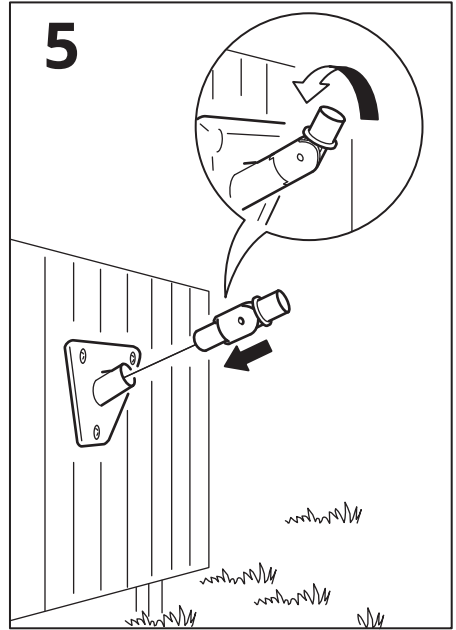
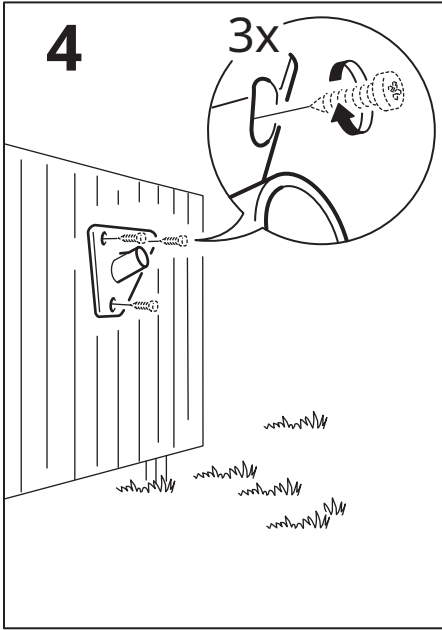



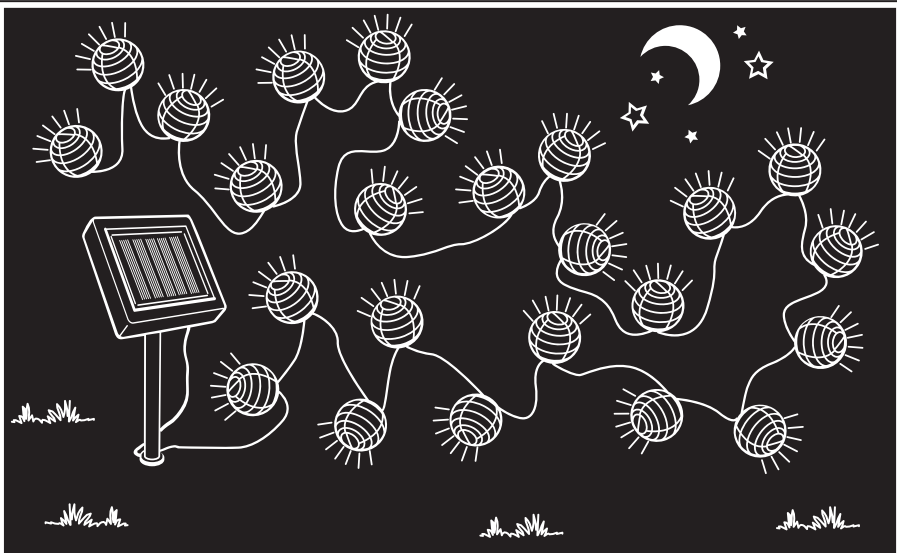
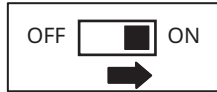
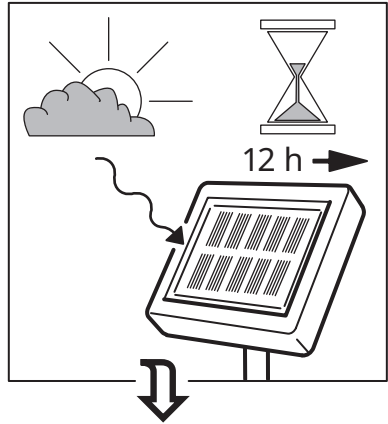
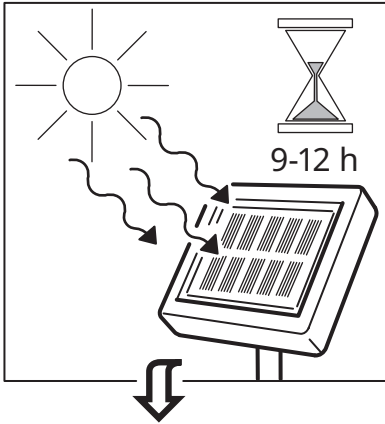



**English**

ALWAYS REMOVE THE BATTERIES BEFORE  
STORING.

**עברית**

הקפידו להוציא את הסוללות לפני האחסון.

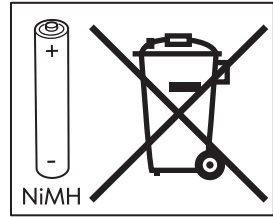
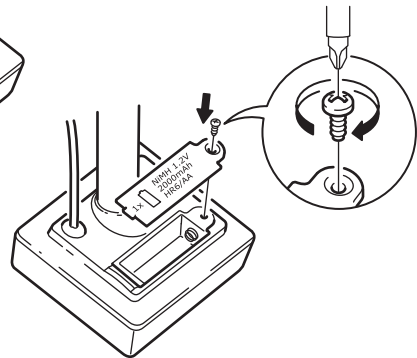
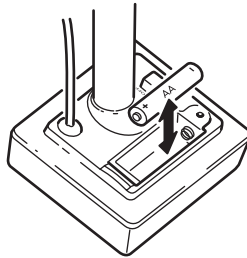
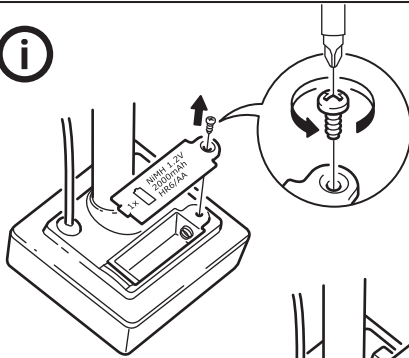

### English

After approximately 2 years, the rechargeable battery needs to be replaced when the lamp doesn't light up. Replace only with Ni-MH rechargeable 1.2V, 2000mAh, AA type batteries. The light source of this luminaire is not replaceable; when the light source reaches its end of life the whole luminaire shall be replaced.

SAVE THESE INSTRUCTIONS FOR FUTURE USE.

### עברית

לאחר כשנתיים, יש להחליף את הסוללות הנטענות כאשר המנורה אינה נדלקת. יש להחליף אך ורק בסוללת Ni-MH נטענת, 1.2V, 2000mAh, AA, מקור האור אינו ניתן להחלפה; לכן, כשמקור האור יגיע לסוף תוחלת חייו, יהיה עליכם להחליף את המנורה כולה. שמרו הוראות אלה לשימוש עתידי.

