

GB

TVÄTTAD



Design and Quality
IKEA of Sweden

ENGLISH

3

Installation

⚠ Warning! Read the safety booklet and refer to assembly instruction. The manufacturer does not accept any responsibility for damage or injury through failure to comply with the safety precaution.

- Make sure that all transit bolts are removed.
- Make sure that hoses and cable are correctly connected.
- At the end of installation you can connect the mains plug to the mains socket. Connect the appliance to an earthed

socket. The rating plate and the 'Technical Data' chapter indicate the necessary electrical ratings. Make sure that they are compatible with the mains power supply. Check that your domestic electrical installation can take the maximum load required, also taking into account any other appliances in use. For any electrical work required to install this appliance, contact our Authorised Service Centre. The manufacturer does not accept any responsibility for damage or injury through failure to comply with the above safety precaution.

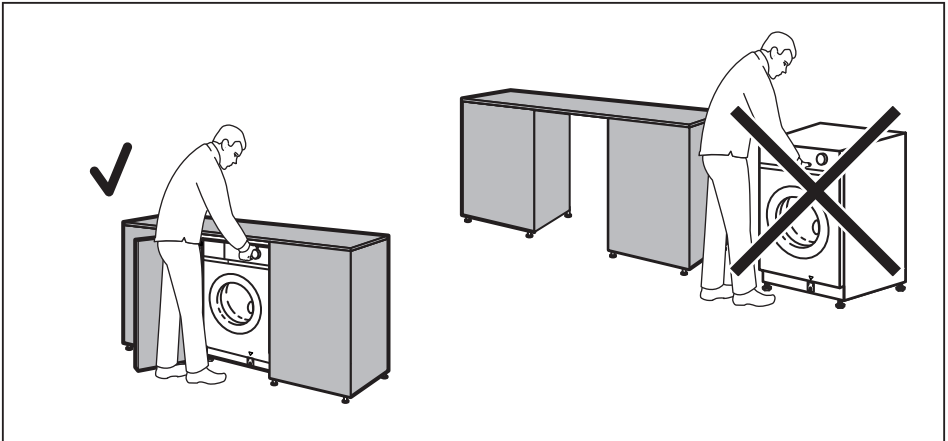

⚠ Warning! Do not install the appliance as free standing.

Technical data

Product type	Built in - Washing Machine	
Dimensions	Width (cm)	59.6
	Height (cm)	81.9
	Total depth (cm)	55.3

Water supply pressure ¹⁾	Minimum	0,5 bar (0,05 MPa)
	Maximum	8 bar (0,8 MPa)

1) If the pressure in your area is lower or higher, please contact your Authorised Service Centre.

i Information on the electrical connection, voltage and overall power is given on the rating plate, on the inner edge of the appliance door.

Appliance overview

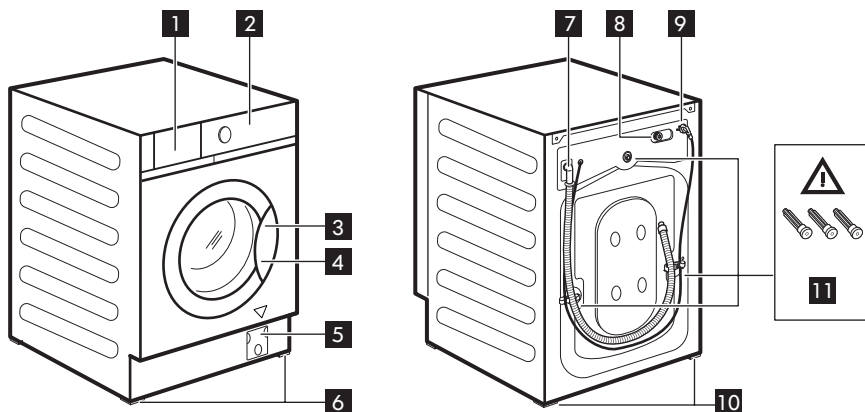

- 1** Detergent dispenser drawer
- 2** Control panel
- 3** Door handle
- 4** Rating plate
- 5** Drain pump filter
- 6** Front feet for levelling the appliance
- 7** Drain hose
- 8** Inlet hose connection
- 9** Mains cable
- 10** Back feet for levelling the appliance

11 Transit bolts

Rating plate position **4**

The data in the following drawing are indicative only. Please check the rating plate of your appliance.

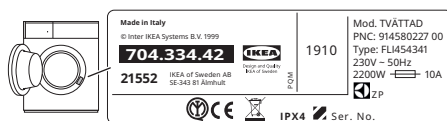











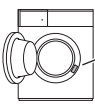





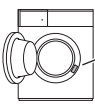

Inspection check list

⚠ Warning! Refer to Safety chapters.

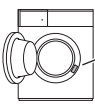
Please follow the inspection check list before using your appliance.

Topics	If the answer is YES <input checked="" type="checkbox"/> , no action is needed	If the answer is NO, please
All transit bolts are removed.	<input type="checkbox"/>	Refer to assembly instruction.
The appliance is built in the furniture following the assembly instructions. It is NOT positioned free-standing.	<input type="checkbox"/>	Install it in the furniture as required. Refer to assembly instruction.
Open and close the detergent dispenser drawer: no collision with furniture.	<input type="checkbox"/>	Refer to 'Filling the detergent and additives' section.
Drain hose correctly connected to the drainage.	<input type="checkbox"/>	Refer to hoses connection description in the assembly instruction.
No water leakage around the hose connections.	<input type="checkbox"/>	Refer to water connection warning in the assembly instruction.
The appliance is connected to an earthed socket.	<input type="checkbox"/>	Refer to 'Electrical connection' section.
The appliance is stable and levelled properly.	<input type="checkbox"/>	Refer to 'Installation' section.
Hoses and mains cable are not kinked.	<input type="checkbox"/>	Refer to 'Electrical connection' and 'Water connection' section.
There is no carpet under the appliance.	<input type="checkbox"/>	Remove the carpet.

i Please write down the product model name, article number and serial number here below that you find in the rating plate and attach your receipt to this page.

Model (Mod.): Article number (Art.No.): Serial number (Ser.No.):	<table border="1"> <tr> <td colspan="2">Art. No.</td> <td colspan="2">Mod.</td> </tr> <tr> <td colspan="2">  </td> <td> Made in Italy © Inver-IT&A-Systems B.V. 1999 704.334.42 </td> <td> 1910 Mod: TVÄTTAD PNC: 914580227 00 Type: FL1454341 230V - 50Hz 2200W  10A IPX4  Ser.No. </td> </tr> <tr> <td colspan="2"> 21552 IKEA of Sweden AB SE-340 91 Alnträsk </td> <td>  </td> <td>   </td> </tr> <tr> <td colspan="4" style="text-align: right;">Ser. No.</td> </tr> </table>	Art. No.		Mod.				Made in Italy © Inver-IT&A-Systems B.V. 1999 704.334.42	1910 Mod: TVÄTTAD PNC: 914580227 00 Type: FL1454341 230V - 50Hz 2200W  10A IPX4  Ser.No.	21552 IKEA of Sweden AB SE-340 91 Alnträsk			 	Ser. No.			
Art. No.		Mod.															
		Made in Italy © Inver-IT&A-Systems B.V. 1999 704.334.42	1910 Mod: TVÄTTAD PNC: 914580227 00 Type: FL1454341 230V - 50Hz 2200W  10A IPX4  Ser.No.														
21552 IKEA of Sweden AB SE-340 91 Alnträsk			 														
Ser. No.																	

Control panel description

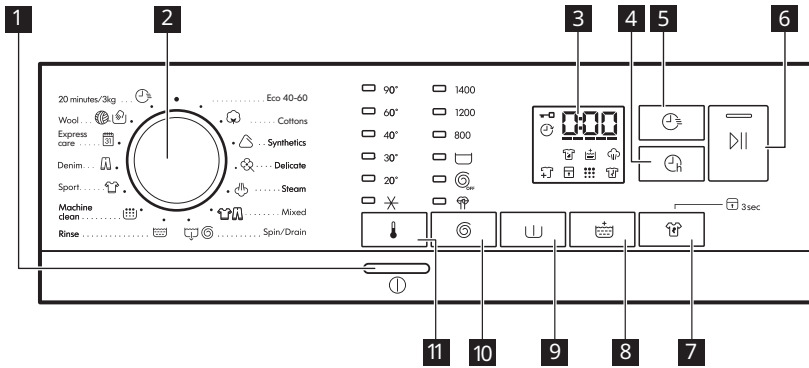

i The options/functions are not available with all washing programmes and an option/function can exclude another one, in these case the appliance doesn't allow an incompatible setting.

1 On/Off button

Press this button for a few seconds to activate or deactivate the appliance. Two different tunes sound while switching the appliance on or off.

According to Commission Regulation EU 2019/2023, this programme at 40 °C is able to clean normally soiled cotton laundry declared to be washable at 40 °C or 60 °C, together in the same cycle.

2 Programme knob

Turn the selector knob to select the desired programme.

Eco 40-60 : Maximum load 8 kg. White cotton and fast-coloured cotton. Normally soiled items.

 For the reached temperature in the laundry, the programme duration and other data, please refer to 'Consumption Values' chapter. The most efficient programmes in terms of energy consumption are generally those that perform at lower temperatures and longer duration.

 **Cottons:** Maximum load 8 kg. White cotton and coloured cotton.

 **Synthetics:** Maximum load 3 kg. Synthetic items or mixed fabric items.

 **Delicate:** Maximum load 2 kg. Delicate fabrics such as acrylics, viscose, polyester items.

 **Steam:** Maximum load 1 kg. Cotton and synthetic items. This programme reduces creases, odours and relaxes the fibres. Do not use any detergent!

 **Mixed :** Maximum load 3 kg. Synthetic fabrics like polyester, polyamide and their blends.

 **Spin/Drain:** Maximum load 8 kg. To spin the laundry and to drain the water in the drum. All fabrics, except woollens and delicate fabrics. If you set the No Spin option, the appliance performs draining only.

 **Rinse:** Maximum load 8 kg. All fabrics, except woollens and very delicate fabrics. Programme for rinsing and spinning.

 **Machine clean:** Empty drum. Maintenance cycle for drum cleaning. Pour a cup of chlorine bleach or a washing machine cleaner in the washing phase compartment. After the drum cleaning, run a further rinse cycle with empty drum and no detergent to remove any residue of bleach.

 **Sport:** Maximum load 3 kg. Sportswear.

















 **Denim:** Maximum load 3 kg. Denim clothing.

 **Express care:** Maximum load 3 kg. Synthetic items or mixed fabric items.

 **Wool:** Maximum load 1.5 kg. Machine washable wool, hand washable wool and other fabrics with «hand washing» care symbol.

 **20 minutes/3kg:** Maximum load 3 kg. Cotton and synthetic items lightly soiled or worn only once.

Display

-  Door locked indicator:
 - Indicator on: the door cannot be opened. The appliance is working or has stopped with water left in the tub.
 - Indicator off: the door can be opened. The programme is finished or the water has been emptied out.
-  Delay start indicator.
-  The digital indicator can show: reset position (); programme duration (e. g. ); delay time (e. g. ); cycle end (); warning code (e.g. ); error indicator ().
-  FlexTime indicator.
-  Anti-stain indicator.
-  Extra Rinse indicator.
-  Steam phase indicator.
-  Add garments indicator. It lights at the beginning of the washing phase, when it is still possible to pause the appliance and add more laundry.
-  Child safety lock indicator.
-  Machine clean indicator. This is a recommendation to perform the drum cleaning.
-  Anti-crease phase indicator.

4 Delay Start

With this option you can delay the start of a program in a more convenient time.

5 FlexTime

With this option reduces the programme duration depending on the load size and the degree of soiling.

When you set a washing programme, the display shows the default duration and the dashes -----.



Tap on this button to reduce the programme duration according to the level of garments soil. The display shows the new programme duration and a number of dashes will decrease accordingly. The shortest is the cycle the smallest should be the load.

6 Start/Pause

This button allows you to start or to pause the selected washing programme.

7 Anti-stains and permanent

Child Lock option 3s

- Touch this button to set the Anti-stains option . This option is designed to remove stubborn stains. Pour the stain remover into PREWASH compartment. NOT selectable with temperature lower than 40 °C.
- Hold pressed this button for 3 seconds to set the Child Lock option  3s. This option prevents children from playing with the control panel: all controls are disabled. To deactivate this option, hold this button pressed for 3 seconds.

8 Extra Rinse



This option increases the number of rinses of the program, minimizing the detergent residuals on the fabrics. Ideal for people with sensitive skin.

9 Prewash

This option adds a prewash phase to a washing program. Ideal to remove particulate soil like mud and clay.

10 Spin and additional options

When you set a programme, the appliance automatically sets the default spin speed. By means of this button, you can change the default spin speed or set one of the additional spin options:

-  Rinse Hold. This option stops the cycle after the last rinse. The water is not drained out to prevent fabrics from creasing. The washing programme ends with water in the drum. You must drain the water to unlock the door.
-  No Spin . Set this option to deactivate all spin phases. Set this option for very delicate fabrics.
-  Quiet Cycle . This option suppresses intermediate and final spin and programme ends with water in the drum. The drum turns regularly to reduce creasing. As the programme is very quiet, it is suitable for use at night time. To finish the cycle perform spin and drain.



 The appliance empties the water out automatically after approximately 18 hours.

11 Temperature

When you select a washing programme, the appliance automatically proposes a default temperature. With this option you can change the temperature.









The indicator  = cold water.

Acoustic signals

This appliance has different acoustic signals. To **activate/deactivate** some of the acoustic signals when the programme is completed, touch the  and the  buttons

simultaneously for about 2 seconds. The display shows On or Off.

Daily use

- ⚠ Warning!** Read the safety booklet.
- i** Before the very first use, pour 2 litres of water into the detergent compartment marked by . Pour 2 litres of water into the detergent compartment marked by . Pour a small quantity of detergent into the compartment marked by . Set and start a programme for cotton at the highest temperature without any laundry in the drum. This removes all possible dirt from the drum and the tub.
1. Make sure that the mains plug is connected to the mains socket.
 2. Make sure that the water tap is open.
 3. Load the laundry.
 4. Pour the detergent and other treatments in the proper compartment of the detergent dispenser.
 5. Push the  button to switch the appliance on.
 6. Turn the programme dial to set the desired programme.
 7. Set the desired options by means of the corresponding touch buttons. The relevant indicator comes on.
 8. To start the programme, touch the  button.
 9. The appliance starts or, if you have set the  option, the countdown starts. When programme starts, thanks to the AutoAdjust System, the appliance automatically adjusts - in 30 seconds - the programme duration to the load to achieve perfect washing results in the minimum possible time.
 10. At the end of the programme, remove the laundry. If you set an option that ends with water in the tub, drain the water to unlock the drum.
 11. Push the  button to switch the appliance off.
- i** The Stand-by function may automatically deactivates the appliance to reduce the energy consumption. Press the  button to activate the appliance again.

Hints and tips

- Sort the laundry as follows: white, coloured, synthetics, delicates and wool.
- Follow the washing instructions on the laundry care labels.
- Button up pillowcases, close zippers, hooks and poppers. Tie up belts.
- Turn multilayered fabrics, wool and items with printed illustrations inside out.
- Pre-treat tough stains. With adequate pre-treatment, stains and limited soiling can be removed; the laundry can then be washed at a lower temperature. Do not spray stain remover on garments near the appliance as it is corrosive to the plastic parts.
- Wash heavy soil stains with a special detergent.
- Be careful with curtains. Remove the hooks and put the curtains in a washing bag or pillowcase.
- Use a washing bag to wash small and/or delicate items (e.g. underwired bras, belts, tights, etc.).

- Avoid washing garments full of long animal hair or poor quality garments releasing lots of fluff that could block the drain circuit and therefore requiring the Service assistance.
- Powder detergents for all types of fabric, excluding delicate. Prefer powder detergents containing bleach for whites and laundry sanitization. At temperature higher than 60 °C the use of powder detergent is recommended.
- Liquid detergents, preferably for low temperature wash programmes (60 °C max) for all types of fabric, or special ones for woollens only.
- The choice and quantity of detergent will depend on: type of fabric (delicates, woollens, cottons, etc), the colour of clothes, size of the load, degree of soiling, wash temperature and hardness of the water used.
- Follow the instructions that you find on packaging of the detergents or other treatments without exceeding the indicated maximum level (**MAX**).
- Do not mix different types of detergents.
- Use less detergent if washing a small loads, the laundry is lightly soiled or there is large amounts of foam during washing.
- When using detergent tabs or pods, always put them inside the drum, not in the detergent dispenser.
- Normally soiled laundry may be washed without prewash in order to save detergent, water and time (the environment is protected too!).
- Loading the appliance to the maximum capacity indicated for each programmes helps to reduce energy and water consumption.
- To use the correct quantity of detergent, refer to the quantity suggested by the detergent producer and check the water hardness of you domestic system.
- Set the maximum possible spin speed for the selected washing programme before drying your laundry in a tumble dryer. This will save energy during drying!

Alarm Codes and Possible failures

The appliance does not start or it stops during operation. First try to find a solution to the problem (refer to the tables).

 **Warning!** Deactivate the appliance before carrying out any check.

With some problems, the display shows an alarm code and the  button may flash continuously:

Problem	Possible solution
<p>E 10 The appliance does not fill with water properly.</p>	<ul style="list-style-type: none"> • Make sure that the water tap is open. • Make sure that the pressure of the water supply is not too low. For this information, contact your local water authority. • Make sure that the water tap is not clogged. • Make sure that the inlet hose has no kinks, damages or bends. • Make sure that the connection of the water inlet hose is correct. • Make sure that the filter of the inlet hose and the filter of the valve are not clogged. Refer to 'Care and cleaning'.

<p>E20 The appliance does not drain the water.</p>	<ul style="list-style-type: none"> • Make sure that the sink spigot is not clogged. • Make sure that the drain hose has no kinks or bends. • Make sure that the drain filter is not clogged. Clean the filter, if necessary. Refer to "Care and cleaning". • Make sure that the connection of the drain hose is correct. • Set the drain programme if you set a programme without drain phase. • Set the drain programme if you set an option which ends with water in the tub.
<p>E40 The appliance door is open or not closed correctly.</p>	<ul style="list-style-type: none"> • Make sure that the door is properly closed.
<p>E91 Internal fail. No communication between electronic elements of the appliance.</p>	<ul style="list-style-type: none"> • The programme was not finished properly or the appliance stopped too early. Switch the appliance off and on again. • If the alarm code appears again, contact the Authorised Service Centre.
<p>E40 The mains supply is unstable.</p>	<ul style="list-style-type: none"> • Wait until mains supply is stable.

We recommend the use of original spare parts. After the check, switch on the appliance and press the button  to restart the programme.

If the problem remains, contact your Authorised Service Centre. The necessary

data for the service centre is on the rating plate. Refer to 'Inspection check list' chapter.

In case of failures not linked to a warning code, please refer to the complete version of the user manual available in the web

Consumption values

Introduction



See the web link www.theenergylabel.eu for detailed information about Energy Label.

- i** The QR code on the energy label supplied with the appliance provides a web link to the information related to the performance of the appliance in the EU EPREL database. Keep the energy label for reference together with the user manual and all other documents provided with this appliance.

It is also possible to find the same information in EPREL using the link <https://eprel.ec.europa.eu> and the model name and product number that you find on the rating plate of the appliance. Refer to 'Product description' chapter for the position of the rating plate.

Legend

kg	Laundry load.	h:mm	Programme duration.
kWh	Energy consumption.	°C	Temperature in the laundry.
Litres	Water consumption.	rpm	Spin speed.
%	Remaining moisture at the end of spinning phase. The higher is the spin speed, the higher is the noise and the lower is the remaining moisture.		

- i** Values and programme duration may differ depending on different conditions (e.g. room temperature, water temperature and pressure, load size and type of laundry, supply voltage) and also if you change the default setting of a programme.

According to Commission Regulation Eu 2019/2023

Eco 40-60 programme	kg	kWh	Litres	h:mm	%	°C	rpm¹⁾
Full load	8	1.300	58	3:30	52	43	1351
Half load	4	0.950	46	2:40	52	43	1351
Quarter load	2	0.500	35	2:40	54	33	1351

1) Maximum spin speed.

Power consumption in different modes

Off (W)	Stand-by (W)	Delay start (W)
0.48	0.48	4.00

Time to Off/Standby mode is 15 minutes maximum.

Common programmes

 These values are indicative only.

Programme	kg	kWh	Litres	h:mm	%	°C	rpm ¹⁾
Cottons ²⁾ 90°C	8	2.20	85	3:55	52	85	1400
Cottons 60°C	8	1.50	80	3:20	52	55	1400
Cottons ³⁾ 20°C	8	0.35	80	2:35	52	20	1400
Synthetics 40°C	3	0.75	75	2:10	35	40	1200
Delicate ⁴⁾ 30°C	2	0.30	50	0:50	35	30	1200
Wool 30°C	1.5	0.25	65	1:05	30	30	1200

1) Reference indicator of the spin speed.

2) Suitable for washing heavily soiled textiles.

3) Suitable for washing lightly soiled cottons.

4) It also performs as quick washing cycle for lightly soiled laundry.

157038510-A-072021

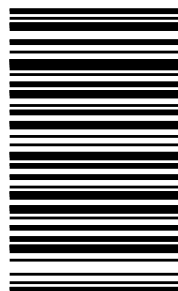

© Inter IKEA Systems B.V. 2021

21552

AA-2226986-1