

LAGAN

en



Design and Quality
Ikea of Sweden

TABLE OF CONTENTS

Safety Instructions	4
Product description	8
Product Control Panel Introduction and Usage	8
First Use	8
Using the Oven	9
Oven Operating Functions	10
Product Accessories	10
Use of Product Accessories	10
General Information About Cooking	11
Maintenance and Cleaning	14
Troubleshooting	16
Technical Specifications	17
Environmental Instructions	17
IKEA guarantee	18

Safety Instructions

- This section includes the safety instructions necessary to prevent the risk of personal injury or material damage.
- If the product is handed over to someone else for personal use or second-hand use purposes, the user's manual, product labels and other relevant documents and parts should also be given.
- Our company shall not be held responsible for damages that may occur if these instructions are not observed.
- Failure to follow these instructions shall void any warranty.
- Always have the installation and repair works made by the manufacturer, the authorised service or a person that the importer company shall designate.
- Use original spare parts and accessories only.
- Do not repair or replace any component of the product unless it is clearly specified in the user's manual.
- Do not make technical modifications on the product.

Intended Use

- This product is designed to be used at home. It is not suitable for commercial use.
- Do not use the product in gardens, balconies or other outdoors. This product is intended to be used in households and in the staff kitchens of shops, offices and other working environments.
- **CAUTION:** This product should be used for cooking purposes only. It should not be used for different purposes, such as heating the room.
- The oven can be used to defrost, bake, fry and grill food.
- This product should not be used for plate heating, drying by hanging towels or clothes on the handle.

Child, Vulnerable Person and Pet Safety

- This product can be used by children 8 years of age and older, and people who are underdeveloped in physical, sensory or mental skills, or who have lack of experience and knowledge, as long as they are supervised or trained about the safe use and hazards of the product.
- Children should not play with the product. Cleaning and user maintenance should not be performed by children unless there is someone overseeing them.
- This product should not be used by people with limited physical, sensory or mental capacity (including children), unless they are kept under supervision or receive the necessary instructions.
- Children should be supervised to ensure that they do not play with the product.
- Electrical products are dangerous for children and pets. Children and pets must not play with, climb on, or enter the product.
- Do not put objects that children may reach on the product.
- **CAUTION:** During use, the accessible surfaces of the product are hot. Keep children away from the product.
- Keep the packaging materials out of the reach of children. There is a hazard of injury and suffocation.
- When the door is open, do not put any heavy objects on it or allow children to sit on it. You may cause the oven to tip over or damage the door hinges.
- Before discarding worn out and useless products:
 1. Unplug the power plug and remove it from the socket.
 2. Cut off the power cable and disconnect it with the plug from the product.
 3. Take precautions to prevent children from entering the product.
 4. Do not allow children to play with product when it is in idle mode.

Electrical Safety

- Plug the product into a grounded outlet protected by a fuse that matches the current ratings indicated on the type label. Have the grounding installation made by a qualified electrician. Do not use the product without grounding in accordance with local / national regulations.
- The plug or the electrical connection of the appliance shall be in an easily accessible place. If this is not possible, there should be a mechanism (fuse, switch, key switch, etc.) on the electrical installation to which the product is connected, in compliance with the electrical regulations and separating all poles from the network.
- Unplug the product or switch off the fuse before repair, maintenance and cleaning.
- Plug the product into an outlet that meets the voltage and frequency values specified on the type label.
- (If your product does not have a mains cable) only use the connecting cable described in the "Technical specifications" section.
- Do not jam the power cable under and behind the product. Do not put a heavy object on the power cable. The power cable should not be bent, crushed, and come into contact with any heat source.
- Make sure that the power cable is not jammed while putting the product to its place after assembly or cleaning.
- The rear surface of the oven gets hot when it is in use. The power cables must not touch the rear surface of the product. Otherwise it might get damaged.
- Do not jam the electric cables into the oven door and do not pass them over hot surfaces. Otherwise, cable insulation may melt and cause fire as a result of short circuit.
- Use original cable only. Do not use cut or damaged cables.
- Do not use an extension cord or multi-plug to operate your product.

- Contact the authorized service centre or importer to use the approved adapter in cases where the use of a converter adapter (for plug type) is necessary.
- Contact the importer or the authorized service centre if the length of the power line is inadequate.
- Portable power sources or multiple plugs may overheat and catch fire. Keep multiple plugs and portable power sources away from the product.
- If the power cable is damaged, it must be replaced by the manufacturer, an authorized service or a person to be specified by the importer company in order to prevent possible dangers.
- **CAUTION:** Before replacing the oven lamp, be sure to disconnect the product from the mains supply to avoid the risk of electric shock. Unplug the product or turn off the fuse from the fuse box.

If your product has a power cable and plug:

- Never put the product plug into a broken, loose, or out-of-socket plug. Make sure the plug is fully inserted into the socket. Otherwise the connections may overheat and cause a fire.
- Avoid inserting the device into plugs that are greasy, unclean, or potentially exposed to water (such as those near a worktop where water may escape). Otherwise there is a risk of short circuit and electrocution.
- Never touch the plug with wet hands!
- Pull the plug out of the socket using the plug's body rather than the cord itself.

Transportation Safety

- Disconnect the product from the mains before transporting the product.
- The product is heavy, carry the product with at least two people.
- Do not use the door and / or handle to transport or move the product.
- Do not place items on the appliance. Carry the appliance vertically.

- When you need to transport the product, wrap it with bubble wrap packaging material or thick cardboard and tape it tightly. Secure the moving parts of the product firmly to prevent damage.
- Before the product is installed, check the product for any damage after transport. Contact the importer or the authorized service centre if damaged.

Installation Safety

- Before beginning the installation, de-energize the power line to which the product will be connected by turning off the fuse.
- Always wear protective gloves during transport and installation. Otherwise there is a risk of injury from sharp edges!
- Before the product is installed, check the product for any damage. Do not have it installed if the product is damaged.
- Avoid using any heat-insulating materials to cover the interior of the furniture that will be installed.
- Direct sunlight and heat sources, such as electric or gas heaters, must not be present in the area where the product is installed.
- Keep the surroundings of all ventilation ducts of the product open.
- To avoid overheating, product installation should not be carried out behind decorative covers.
- In cases where a gas hose/pipe or plastic water pipe is situated behind the designated installation area for the product, it is imperative to guarantee that there is no contact between the product and these utility lines. Otherwise the hose/pipe may be crushed.
- If there is a socket behind the place where the product will be installed, it must be ensured that the product does not come into contact with the socket nor with the plug plugged into the socket.

Safety of Use

- Ensure that the appliance is switched off after every use.

- If you will not use the product for a long time, unplug it or turn off the power from the fuse box.
- Don't use the product if it breaks down or gets damaged while being used. Disconnect the product from the electricity. Contact the importer or the authorized service centre.
- Do not use the product if the front door glass is removed or cracked. Otherwise there is a risk of injury and environmental damage.
- Do not step on the appliance for any reason.
- Never use the product when your judgement or coordination is impaired by the use of alcohol and/or drugs.
- Flammable objects must not be kept in and around the cooking area. Otherwise, these may lead to fire.
- The oven handle is not a towel dryer. When using the product, do not hang towels, gloves or similar textiles on the handle.
- The hinges of the product door move when opening and closing the door and might jam. When opening / closing the door, do not hold the part with the hinges.

Temperature Warnings

- **CAUTION:** When the product is in use, the product and its accessible parts will be hot. Care should be taken to avoid touching the product and heating elements. Children under 8 years of age should be kept away from the product unless constantly supervised.
- Do not place flammable / explosive materials near the product, as the surfaces will be hot while it is operating.
- Keep your distance when opening the oven door during or at the end of cooking. The steam may burn your hand, face and/or eyes.
- During operation the product is hot. Care should be taken to avoid touching hot parts, inside of the oven and heating elements.
- Always wear heat-resistant oven gloves when handling the product.

Accessory Use

- It is important to use the accessories provided with the product appropriately. For detailed information, refer to the section "**Use of Product Accessories**".
- Close the oven door after pushing the accessories completely into the cooking space, otherwise they may hit the door glass and damage it.

Cooking Safety

- Be careful when using alcoholic drinks in your dishes. Alcohol evaporates at high temperatures and may cause fire since it can ignite when it comes into contact with hot surfaces.
- Food residues in the cooking area., such as oil, can ignite. Clean these residues before cooking.
- Food Poisoning Hazard: Do not let food sit in oven for more than 1 hour before or after cooking. Otherwise it may cause food poisoning or diseases.
- Do not heat closed tins and glass jars in the oven. The pressure that would build-up in the tin/jar may cause it to burst.
- When the oven is in use, NEVER place baking tray, dishes or aluminium foil directly on the bottom of the oven. The heat accumulation might damage the bottom of the oven, and might even cause damage to the oven cabinet or kitchen flooring.

Be mindful of the following precautions when using greasy parchment paper or similar materials:

- Place the greaseproof paper in a cookware or on the oven accessory (tray, wire grill, etc.) with food and place it in the preheated oven.
- To prevent the risk of touching the oven heating elements and obstructing the flow of hot air, remove any excess parts of

- greaseproof paper that hang from accessories or containers. Do not use greaseproof paper at oven temperatures higher than the maximum usage temperature specified by the manufacturer. Never place greaseproof paper on the oven base.
- Do not place it on top of accessories during preheating.
- Always press down with a plate or similar object to prevent the material from flying around due to the air circulation inside the oven.
- Only cover the necessary surface inside the tray.
- After each use, the tray should be cleaned, and any greaseproof paper or similar materials used in the tray should be replaced. Otherwise, liquids dripping onto the tray can cause smoking or even ignite flames.
- An air flow is generated when the product lid is opened. Greaseproof paper can come into contact with heating elements and ignite.
- When using wire grill, a tray should be placed on the lower rack. Otherwise, the food oil and other components that drip onto the oven bottom can create heavy smoke and lead to flames.

Maintenance and Cleaning Safety

- Wait for the product to cool before cleaning the product. Hot surfaces may cause burns!
- Never wash the product by spraying or pouring water on it! There is the risk of electric shock!
- Do not use steam cleaners to clean the product as this may cause an electric shock.
- Do not use harsh abrasive cleaners, metal scrapers, wire wool or bleach materials to clean the oven front door glass. These materials can cause glass surfaces to be scratched and broken.

Product description

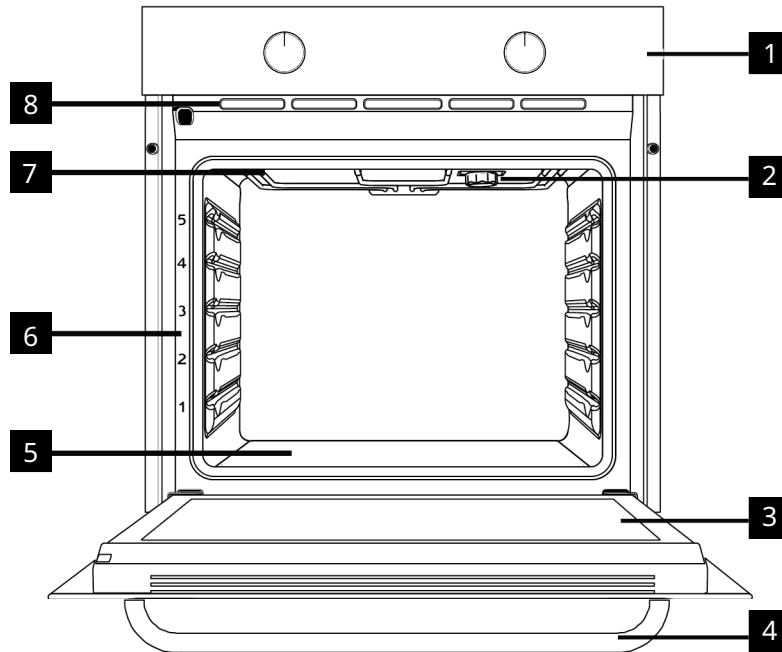

- | | |
|---|----------------------------|
| 1 Control panel | 2 Lamp |
| 3 Door | 4 Handle |
| 5 Lower heater (under the steel plate) | 6 Shelf positions |
| 7 Upper heater | 8 Ventilation holes |

Product Control Panel Introduction and Usage

In this section, you can find the overview and basic uses of the product's control panel. There may be differences in images and some features depending on the type of product.

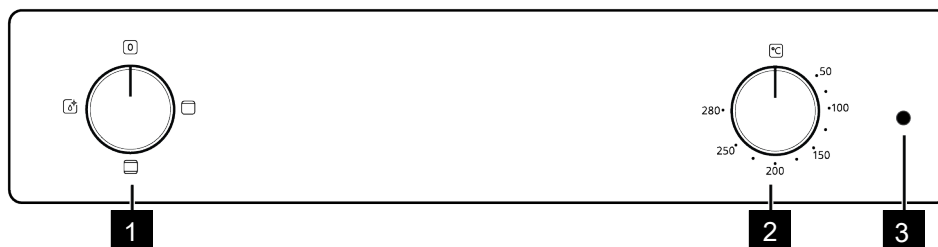

- | | |
|----------------------------------|---------------------------|
| 1 Function selection knob | 2 Temperature knob |
| 3 Thermostat lamp | |

Function selection knob

You can select the oven operating functions with the function selection knob. Turn left / right from closed (top) position to select.

Temperature knob

You can select the temperature you want to cook with the temperature knob. Turn clockwise from the closed (top) position to select.

Oven inner temperature indicator

You can understand the oven interior temperature from the temperature lamp. The thermostat lamp is located on the control panel. The thermostat lamp turns on when the product starts to operate, and the thermostat lamp turns off when it reaches the set temperature. When the temperature inside the oven drops below the set temperature, the thermostat lamp turns on again.

First Use

Before you start using your product, it is recommended to do the following stated in the following sections respectively.

Initial Cleaning

1. Remove all packaging materials.
2. Remove all accessories from the oven provided with the product.

3. Operate the product for 30 minutes and then, turn it off. This way, residues and layers that may have remained in the oven during production are burned and cleaned.
4. When operating the product, select the highest temperature and the operating function that all the heaters in your product operate. See "Oven operating functions". You can learn how to operate the oven in the following section.
5. Wait for the oven to cool.

- Wipe the surfaces of the product with a wet cloth or sponge and dry with a cloth.

Before using the accessories:

Clean the accessories you remove from the oven with detergent water and a soft cleaning sponge.

NOTICE: Some detergents or cleaning agents may cause damage to the surface. Do not use abrasive detergents, cleaning powders, cleaning creams or sharp objects during cleaning.

NOTICE: During the first use, smoke and odour may come up for several hours. This is normal and you just need good ventilation to remove it. Avoid directly inhaling the smoke and odours that form.

Electrical connection

⚠ General warnings

- Disconnect the product from the power supply before beginning any work on the electrical installation. There is a risk of electric shock.
- Connect the product to a grounded socket/line protected by a miniature circuit breaker (fuse) of appropriate capacity as specified in the "Technical Specifications" table. Have the grounding performed by a qualified electrician before using the product with or without a transformer. Our company does not accept responsibility for damages resulting from failure to comply with the requirement for the product to be used with a grounded installation in accordance with local regulations.
- The product can only be connected to the mains power supply by an authorized and qualified person, and the product warranty only begins after correct installation. The manufacturer cannot be held responsible for damages resulting from work performed by unauthorized persons.
- The power cord must not be crushed, folded, compressed, or come into contact with hot parts of the product. If the power cord is damaged, it must be replaced by a qualified electrician.
- The mains supply data must correspond to the data specified on the type label of the product. The rating plate is either seen when the door or the lower cover of the appliance is opened or it is located at the rear wall of the appliance depending on the appliance type.
- Power cable plug must be within easy reach after installation (do not route it above the hob). Do not use extension or multi sockets in power connection.

- When installing the wiring, you must comply with national/local electrical regulations and use the appropriate plug and outlet for the product. If the power limits of the product exceed the current carrying capacity of the plug and outlet/outlet, you must connect the product directly to the fixed electrical installation without using a plug and outlet/outlet.
- If the product will be connected directly to the supply power:** If it is not possible to disconnect all poles in the supply power, a disconnection unit with at least 3 mm contact clearance (fuses, line safety switches, contactors) must be connected and all the poles of this disconnection unit must be adjacent to (not above) the product in accordance with IEE directives. Failure to obey this instruction may cause operational problems and invalidate the product warranty.
- Additional protection by a residual current circuit breaker is recommended.

If the product is produced with cable and without plug:

Connect the cord of product to supply power as identified below:

Make the terminal block connection of your product according to the connection/phase information on the product type label.

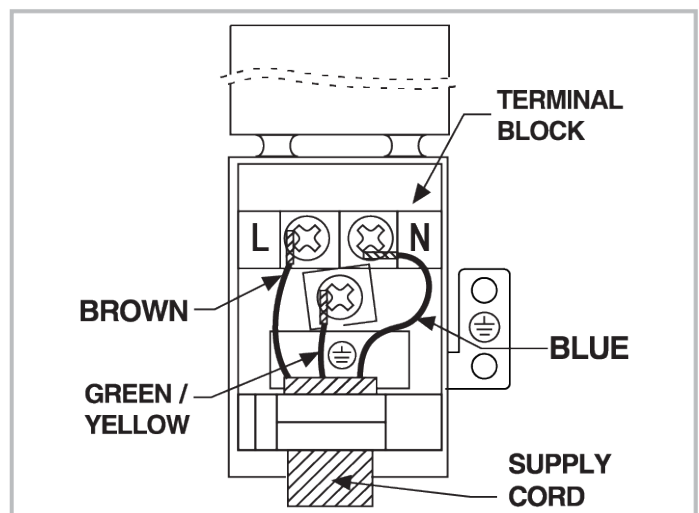

If your supply cord type is 3-conductor type, for 1-phase connection:

- Brown = L (Phase)
- Blue = N (Neutral)
- Green/Yellow wire = (E)  (Earthing)

Using the Oven

General Information on Using the Oven

Cooling fan

Your product has a cooling fan. The cooling fan is activated automatically when necessary and cools both the front of the product and the furniture. It is automatically deactivated when the cooling process is finished. Hot air comes out over the oven door. Refrain from covering these ventilation openings. Otherwise, the oven may overheat. The cooling fan

continues to operate during oven operation or after the oven is turned off (approximately 20-30 minutes). If you cook by programming the oven timer, at the end of the baking time, the cooling fan turns off with all functions. The cooling fan running time cannot be determined by the user. It turns on and off automatically. This is not an error.

Oven lighting

The oven lighting is turned on when the oven starts baking. The lighting is on during baking.

Operation of the Oven Control Unit

Turning on the oven

When you select a operating function you want to cook with the function selection knob and set a certain temperature with the temperature knob, the oven starts operating.

Turning off the oven

You can turn the oven off by turning the function selection knob and temperature knob to the off (up) position.

Selecting the temperature and oven operating function

You can cook by making a manual control (at your own control) by selecting the temperature and operating function specific to your food.

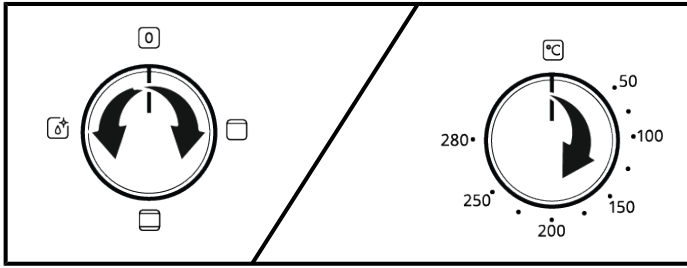

1. Select the operating function you want to cook with the function selection knob.
 2. Set the temperature you want to cook with the temperature knob.
- ⇒ Your oven will start operating immediately at the selected function and temperature, and the thermostat lamp will turn on. When the temperature inside the oven reaches the desired temperature, the thermostat lamp will turn off. The oven will not turn off by itself after the baking process. You have to control baking and turn it off yourself. When your baking is completed, turn off the oven by turning the function selection knob and the temperature knob to the off (up) position.

Oven Operating Functions

On the function table, the operating functions you can use in your oven and the highest and lowest temperatures that can be set for these functions are shown. The order of the operating modes shown here may differ from the arrangement on your product.

Function symbol	Function description	Temperature range (°C)	Description and use
	Top and bottom heating	*	Food is heated from above and below at the same time. Suitable for cakes, pastries or cakes and stews in baking moulds. Cooking is done with a single tray.
	Top heating	*	Only upper heating is on. It is suitable for foods that need browning on the top.
	Bottom heating / Easy steam cleaning	*	Only lower heating is on. It is suitable for foods that need browning on the bottom. This function should also be used for easy steam cleaning.

* Your product operates in the temperature range specified on the temperature knob.

Product Accessories

There are various accessories in your product. In this section, the description of the accessories and the descriptions of the correct usage are available. Depending on the product model, the supplied accessory varies. All accessories described in the user's manual may not be available in your product.

i The trays inside your appliance may be deformed with the effect of the heat. This has no effect on the functionality. Deformation disappears when the tray is cooled.

Standard tray

It is used for pastries, frozen foods and frying large pieces.

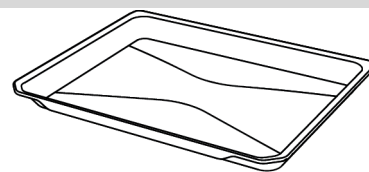

Wire grill

It is used for frying or placing the food to be baked, fried and stewed on the desired shelf.

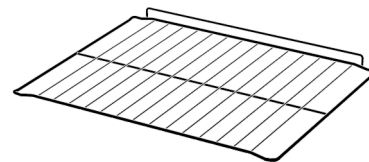

Use of Product Accessories

Cooking shelves

There are 5 levels of shelf position in the cooking area. You can also see the order of the shelves in the numbers on the front frame of the oven.

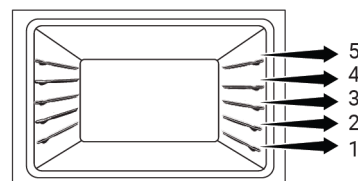

Placing the wire grill on the cooking shelves

It is crucial to place the wire grill on the side shelves properly. The wire grill has one direction when placing it on the shelf. While placing the wire grill on the desired shelf, the open section must be on the front.

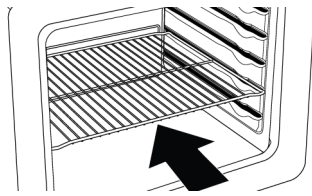

Placing the tray on the cooking shelves

It is also crucial to place the trays on the side shelves properly. The tray has one direction when placing it on the shelf. While placing the tray on the desired shelf, its side designed for holding must be on the front.

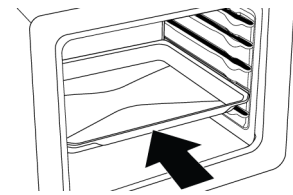

Stopping function of the wire grill

There is a stopping function to prevent the wire grill from tipping out of the wire shelf. With this function, you can easily and safely take out your food. While removing the wire grill, you can pull it forward until it reaches the stopping point. You must pass over this point to remove it completely.

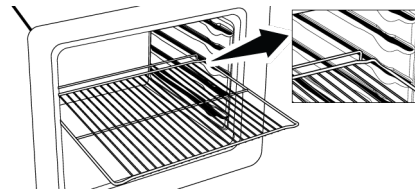

Child safety lock

This product has a child lock on the oven door. To open the oven door, lift the plastic part slightly upwards and pull the door handle. When close the door, child lock will be locked itself.

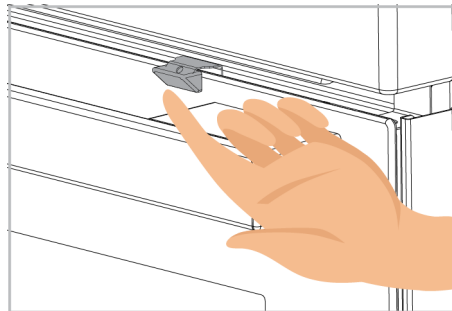

To remove the child lock:

Remove the two screws that secure the child lock safety as shown in the figure. When you want to use it again, you can secure it under the control panel with the fixing materials.

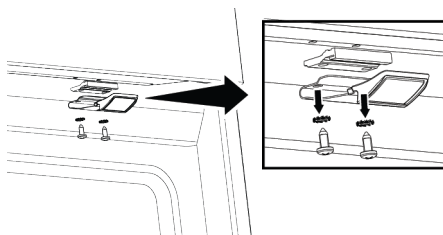

General Information About Cooking

You can find tips on preparing and cooking your food in this section.

Plus, this section describes some of the foods tested as producers and the most appropriate settings for these foods. Appropriate oven settings and accessories for these foods are also indicated.

General Warnings About Baking in the Oven

- While opening the oven door during or after baking, hot-burning steam may emerge. The steam may burn your hand, face and/or eyes. When opening the oven door, stay away.
- Intense steam generated during baking may form condensed water drops on the interior and exterior of the oven and on the upper parts of the furniture due to the temperature difference. This is a normal and physical occurrence.
- The cooking temperature and time values given for foods may vary depending on the recipe and amount. For this reason, these values are given as ranges.
- Always remove unused accessories from the oven before you start cooking. Accessories that will remain in the oven may prevent your food from being cooked at the correct values.
- For foods that you will cook according to your own recipe, you can reference similar foods given in the cooking tables.

- Using the supplied accessories ensures you get the best cooking performance. Always observe the warnings and information provided by the manufacturer for the external cookware you will use.
- Cut the greaseproof paper you will use in your cooking in suitable sizes to the container you will cook. Greaseproof papers that are overflowing from the container can create a risk of burns and affect the quality of your baking. Use the greaseproof paper you will use in the temperature range specified.
- For good baking performance, place your food on the recommended correct shelf. Do not change the shelf position during baking.

Pastries and oven food

General Information

- We recommend using the accessories of the product for a good cooking performance. If you will use an external cookware, prefer dark, non-sticking and heat resistant ware.
- If preheating is recommended in the cooking table, be sure to put your food in the oven after preheating.
- If you will cook by using cookware on the wire grill, place it in the middle of the wire grill, not near the back wall.
- All materials used in making pastry should be fresh and at room temperature.
- The cooking status of the foods may vary depending on the amount of food and the size of the cookware.

- Metal, ceramic and glass moulds extend the cooking time and the bottom surfaces of pastry foods do not brown evenly.
- If you are using baking paper, a small browning can be observed on the bottom surface of the food. In this situation, you may have to extend your cooking period by approximately 10 minutes.
- The values specified in the cooking tables are determined as a result of the tests carried out in our laboratories. Values suitable for you may differ from these values.
- Place your food on the appropriate shelf recommended in the cooking table. Refer to the bottom shelf of the oven as shelf 1.
- Cook the recommended dishes in the cooking table with a single tray.

Tips for baking cakes

- If the cake is too dry, increase the temperature by 10°C and shorten the baking time.
- If the cake is moist, use a small amount of liquid or reduce the temperature by 10°C.

- If the top of the cake is burnt, put it on the lower shelf, lower the temperature and increase the baking time.
- If the inside of the cake is cooked well, but outside is sticky, use less liquid, decrease the temperature and increase the cooking time.

Hints for pastry

- If the pastry is too dry, increase the temperature by 10 °C and shorten the cooking time. Wet the dough sheets with a sauce consisting of milk, oil, egg and yoghurt mixture.
- If the pastry is getting cooked slowly, make sure that the thickness of the pastry you have prepared does not overflow the tray.
- If the pastry is browned on the surface but the bottom is not cooked, make sure that the amount of sauce you will use for the pastry is not too much at the bottom of the pastry. For an even browning, try to spread the sauce evenly between the dough sheets and the pastry.
- Bake your pastry in the position and temperature appropriate to the cooking table. If the bottom is still not browned enough, place it on a bottom shelf for the next cooking.

Cooking table for pastries and oven foods

Food	Accessory to be used	Operating function	Shelf position	Temperature (°C)	Baking time (min) (approx.)
Cake on the tray	Standard tray *	Top and bottom heating	3	180	30 ... 45
Cake in the mould	Cake mould on wire grill **	Top and bottom heating	2	170 - 180	30 ... 60
Small cakes	Standard tray *	Top and bottom heating	3	160	25 ... 35
Sponge cake	Round springform pan, 26 cm in diameter on wire grill **	Top and bottom heating	2	160	25 ... 40
Cookie	Pastry tray *	Top and bottom heating	3	170	25 ... 40
Rich pastry	Standard tray *	Top and bottom heating	2	200	30 ... 50
Dough pastry	Standard tray *	Top and bottom heating	2	200	20 ... 35
Whole bread	Standard tray *	Top and bottom heating	3	200	30 ... 45
Lasagne	Glass / metal rectangular container on wire grill **	Top and bottom heating	2 or 3	200	30 ... 45
Apple pie	Round black metal mould, 20 cm in diameter on wire grill **	Top and bottom heating	2	180	50 ... 70
Pizza	Standard tray *	Top and bottom heating	2	250	10 ... 20

Preheating is recommended for all food.

*These accessories may not be included with your product.

**These accessories are not included with your product. They are commercially available accessories.

Meat, Fish and Poultry

The key points on grilling

- Seasoning it with lemon juice and pepper before cooking whole chicken, turkey and large pieces of meat will increase cooking performance.
- It takes 15 to 30 minutes more to cook boned meat than fillet by frying.
- You should calculate about 4 to 5 minutes of cooking time per centimetre of the meat thickness.

- After the cooking time is expired, keep the meat in the oven for approximately 10 minutes. The juice of the meat is better distributed to the fried meat and does not come out when the meat is cut.
- Fish should be placed on the medium or low level shelf in a heat resistant plate.
- Cook the recommended dishes in the cooking table with a single tray.

Cooking table for meat, fish and poultry

Food	Accessory to be used	Operating function	Shelf position	Temperature (°C)	Baking time (min) (approx.)
Steak (whole) / Roast (1 kg)	Standard tray *	Top and bottom heating	3	15 mins. 250/max, after 180 ... 190	60 ... 80
Lamb's shank (1,5-2 kg)	Standard tray *	Top and bottom heating	3	15 mins. 250/max, after 170	110 ... 120
Fried chicken (1,8-2 kg)	Wire grill * Place one tray on a lower shelf	Top and bottom heating	2	15 mins. 250/max, after 190	60 ... 80
Turkey (5.5 kg)	Standard tray *	Top and bottom heating	1	25 mins. 250/max, after 180 ... 190	150 ... 210
Fish	Wire grill * Place one tray on a lower shelf	Top and bottom heating	3	200	20 ... 30

Preheating is recommended for all food.

*These accessories may not be included with your product.

**These accessories are not included with your product. They are commercially available accessories.

Test foods

- Foods in this cooking table are prepared according to the EN 60350-1 standard to facilitate testing of the product for control institutes.

- Cook the recommended dishes in the cooking table with a single tray.

Cooking table for test meals

Food	Accessory to be used	Operating function	Shelf position	Temperature (°C)	Baking time (min) (approx.)
Shortbread (sweet cookie)	Standard tray *	Top and bottom heating	3	140	20 ... 30
Small cakes	Standard tray *	Top and bottom heating	3	160	25 ... 35
Sponge cake	Round springform pan, 26 cm in diameter on wire grill **	Top and bottom heating	2	160	25 ... 40
Apple pie	Round black metal mould, 20 cm in diameter on wire grill **	Top and bottom heating	2	180	50 ... 70

Preheating is recommended for all food.

*These accessories may not be included with your product.

**These accessories are not included with your product. They are commercially available accessories.

Yogurt

Preparation of yogurt;

1. Remove the accessories and side wire shelves (if any) from the cooking area.

2. Place the yogurt cookware on the bottom of the cooking area.
3. After preparing the yogurt, let it rest in the refrigerator for at least 12 hours.

Food	Operating function	Shelf position	Temperature (°C)	Baking time (min) (approx.)
Yogurt	Top heating	Bottom of the cooking area	50 - 60	240 ... 360

Maintenance and Cleaning

General Cleaning Information

General warnings

- Wait for the product to cool before cleaning the product. Hot surfaces may cause burns!
- Do not apply the detergents directly on the hot surfaces. This may cause permanent stains.
- The product should be thoroughly cleaned and dried after each operation. Thus, food residues shall be easily cleaned and these residues shall be prevented from burning when the product is used again later. Thus, the service life of the appliance extends and frequently faced problems are decreased.
- Do not use steam cleaning products for cleaning.
- Some detergents or cleaning agents cause damage to the surface. Unsuitable cleaning agents are: bleach, cleaning products containing ammonia, acid or chloride, steam cleaning products, descaling agents, stain and rust removers, abrasive cleaning products (cream cleaners, scouring powder, scouring cream, abrasive and scratching scrubber, wire, sponges, cleaning cloths containing dirt and detergent residues).
- No special cleaning material is needed in the cleaning made after each use. Clean the appliance using dishwashing detergent, warm water and a soft cloth or sponge and dry it with a dry cloth.
- Be sure to completely wipe off any remaining liquid after cleaning and immediately clean any food splashing around during cooking.
- Do not wash any component of your appliance in a dishwasher unless otherwise stated in the user's manual.

Inox - stainless surfaces

- Do not use acid or chlorine-containing cleaning agents to clean stainless-inox surfaces and handles.
- Stainless-inox surface may change colour in time. This is normal. After each operation, clean with a detergent suitable for the stainless or inox surface.
- Clean with a soft soapy cloth and liquid (non-scratching) detergent suitable for inox surfaces, taking care to wipe in one direction.
- Remove lime, oil, starch, milk and protein stains on the glass and inox surfaces immediately without waiting. Stains may rust under long periods of time.
- Cleaners sprayed/applied to the surface should be cleaned immediately. Abrasive cleaners left on the surface cause the surface to turn white.

Enamelled surfaces

- The oven must cool down before cleaning the cooking area. Cleaning on hot surfaces shall create both fire hazard and damage the enamel surface.
- After each use, clean the enamel surfaces using dishwashing detergent, warm water and a soft cloth or sponge and dry them with a dry cloth.
- If your product has an easy steam cleaning function, you can make easy steam cleaning for light non-permanent dirt. (See "Easy Steam Cleaning [▶ 15]".)

- For difficult stains, an oven and grill cleaner recommended on the website of your product brand and a non-scratching scouring pad can be used. Do not use an external oven cleaner.

Glass surfaces

- When cleaning glass surfaces, do not use hard metal scrapers and abrasive cleaning materials. They can damage the glass surface.
- Clean the appliance using dishwashing detergent, warm water and a microfiber cloth specific for glass surfaces and dry it with a dry microfiber cloth.
- If there is residual detergent after cleaning, wipe it with cold water and dry with a clean and dry microfiber cloth. Residual detergent may damage the glass surface next time.
- Under no circumstances should the dried-up residue on the glass surface be cleaned off with serrated knives, wire wool or similar scratching tools.
- You can remove the calcium stains (yellow stains) on the glass surface with the commercially available descaling agent, with a descaling agent such as vinegar or lemon juice.
- If the surface is heavily soiled, apply the cleaning agent on the stain with a sponge and wait a long time for it to work properly. Then clean the glass surface with a wet cloth.
- Discolorations and stains on the glass surface are normal and not defects.

Plastic parts and painted surfaces

- Clean plastic parts and painted surfaces using dishwashing detergent, warm water and a soft cloth or sponge and dry them with a dry cloth.
- Do not use hard metal scrapers and abrasive cleaners. They may damage the surfaces.
- Ensure that the joints of the components of the product are not left damp and with detergent. Otherwise, corrosion may occur on these joints.

Cleaning Accessories

Do not put the product accessories in a dishwasher unless otherwise stated in the user's manual.

Cleaning the Control Panel

- When cleaning the panels with knob-control, wipe the panel and knobs with a damp soft cloth and dry with a dry cloth. Do not remove the knobs and gaskets underneath to clean the panel. The control panel and knobs may be damaged.
- While cleaning the inox panels with knob control, do not use inox cleaning agents around the knob. The indicators around the knob can be erased.
- Clean the touch control panels with a damp soft cloth and dry with a dry cloth. If your product has a key lock feature, set the key lock before performing control panel cleaning. Otherwise, incorrect detection may occur on the keys.

Cleaning the inside of the oven (cooking area)

Follow the cleaning steps described in the "General Cleaning Information" section according to the surface types in your oven.

Easy Steam Cleaning

Function symbol	Function description	Temperature (°C)	Time mins.
	Easy steam cleaning	100	15

This allows cleaning of the dirt (not remaining for a long time) that is softened by the steam inside the oven and by the water droplets condensed in the internal surfaces of the oven easily.

1. Remove all accessories inside the oven.
2. Add 500 ml water into the tray and place it on the 2nd shelf of the oven.

 Do not use distilled or filtered water. Use ready-made waters only. Do not use flammable, alcoholic or solid particulate solutions instead of water.

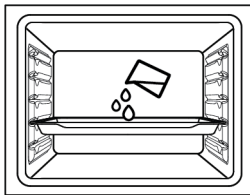

3. Set the oven to the easy steam cleaning operating mode and operate it at 100°C for 15 minutes.

Immediately open the door and wipe the oven interiors with a wet sponge or cloth. Steam will be released when opening the door. This may pose a risk of burns. Be careful when opening the door.

For stubborn dirt, clean the product using dishwashing detergent, warm water and a soft cloth or sponge and dry it with a dry cloth.

 In the easy steam cleaning function, it is expected that the added water evaporates and condenses on the inside of the oven and the oven door in order to soften the light dirt formed in your oven. Condensation formed on the oven door may drip around when the oven door is opened. As soon as you open the oven door, wipe off the condensation.

After the condensation inside the oven, puddle or moisture may occur in the pool channel under the oven. Wipe this pool channel with a damp cloth after use and dry it.

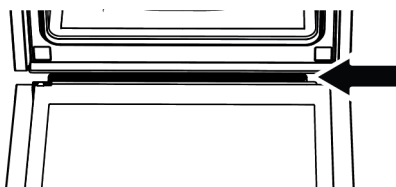

Cleaning the Oven Door

You can remove your oven door and door glasses to clean them. How to remove the doors and windows is explained in the sections "**Removing the oven door**" and "**Removing the inner glasses of the door**". After removing the door inner glasses, clean them using a dishwashing detergent, warm water and a soft cloth or sponge and dry them with a dry cloth. For lime residue that may form on the oven glass, wipe the glass with vinegar and rinse.

 Do not use harsh abrasive cleaners, metal scrapers, wire wool or bleach materials to clean the oven door and glass.

Removing the oven door

1. Open the oven door.
2. Open the clips in the front door hinge socket on the right and left by pushing them with a tool downwards as shown in the figure.

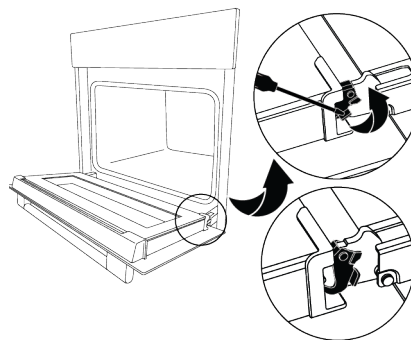

3. Get the oven door to a half-open position.

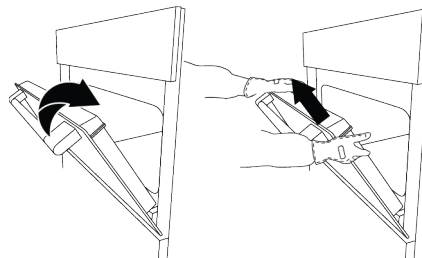

4. Pull the removed door upwards to release it from the right and left hinges and remove it.

 Do not put your fingers around hinge which has a strong spring and may hurt fingers.

To reattach the door

1. Get the oven door to a half-open position.

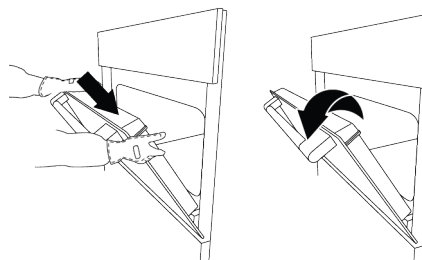

2. Push the removed door downwards to place it from the right and left hinges and open the oven door fully.
3. Close the clips in the front door hinge socket on the right and left by pushing them with a tool upwards as shown in the figure.

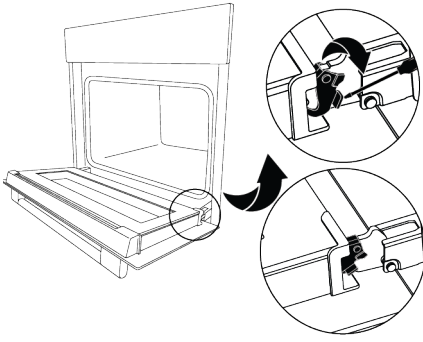

Removing the Inner Glass of The Oven Door

Inner glass of the product's front door may be removed for cleaning.

1. Open the oven door.
2. Pull the plastic component, attached on the upper section of the front door, towards yourself by simultaneously pushing on the pressure points on both sides of the component and remove it.

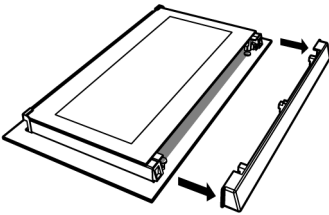
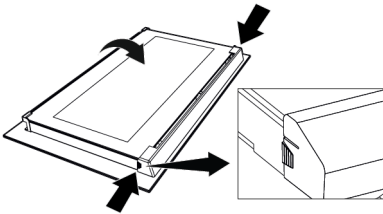

3. As shown in the figure, gently lift the innermost glass (1) towards "A" and then, remove it by pulling towards "B".

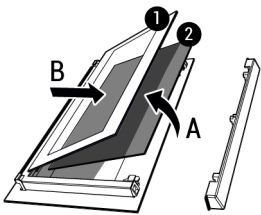

- 1 Innermost glass 2 Inner glass
4. If your product has an inner glass (2), repeat the same process to detach it (2).
 5. The first step of regrouping the door is to reassemble the inner glass (2). Place the bevelled edge of the glass to meet the bevelled edge of the plastic slot. (If your product has an inner glass). Inner glass (2) must be attached to the plastic slot closest to the innermost glass (1).

Troubleshooting

If the problem persists after following the instructions in this section, contact your vendor or an Authorized Service. Never try to repair your product yourself.

Steam is emanated while the oven is working.

- It is normal to see vapour during operation. >>> This is not an error.

6. While reassembling the innermost glass (1), pay attention to place the printed side of the glass on the inner glass. It is crucial to place the lower corners of the innermost glass (1) to meet the lower plastic slots.
7. Push the plastic component towards the frame until a "click" sound is heard.

Cleaning the Oven Lamp

In the event that the glass door of the oven lamp in the cooking area becomes dirty; clean using dishwashing detergent, warm water and a soft cloth or sponge and dry with a dry cloth. In case of oven lamp failure, you can replace the oven lamp by following the sections that follow.

Replacing the oven lamp

General Warnings

- To avoid the risk of electric shock before replacing the oven lamp, disconnect the product and wait for the oven to cool. Hot surfaces may cause burns!
- This oven is powered by an incandescent lamp with less than 40 W, less than 60 mm in height, less than 30 mm in diameter, or a halogen lamp with G9 sockets with less than 60 W power. Lamps are suitable for operation at temperatures above 300 °C. Oven lamps are available from Authorised Services or licensed technicians. This product contains a G energy class lamp.
- The position of the lamp may differ from that is shown in the figure.
- The lamp used in this product is not suitable for use in the lighting of home rooms. The purpose of this lamp is to help the user see food products.
- The lamps used in this product must withstand extreme physical conditions such as temperatures above 50 °C.

If your oven has a round lamp,

1. Disconnect the product from the electricity.
2. Remove the glass cover by turning it counter clockwise.

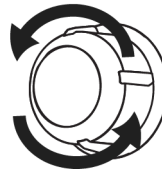

3. If your oven lamp is type (A) shown in the figure below, rotate the oven lamp as shown in the figure and replace it with a new one. If it is type (B) model, pull it out as shown in the figure and replace it with a new one.

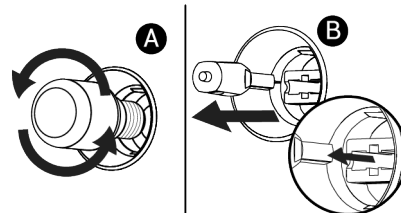

4. Refit the glass cover.

Water droplets appear while cooking

- The steam generated during cooking condenses when it comes into contact with cold surfaces outside the product and may form water droplets. >>> This is not an error.

Metal sounds are heard while the product is warming and cooling.

- Metal parts may expand and make sounds when heated. >>> This is not an error.

The product does not work.

- Fuse may be faulty or blown. >>> Check the fuses in the fuse box. Change them if necessary or reactivate them.
- The appliance may not be plugged to the (grounded) outlet. >>> Check if the appliance is plugged in to the outlet.
- (If there is timer on your appliance) Keys on the control panel do not work. >>> If your product has a key lock, the key lock may be enabled, disable the key lock.

Oven light is not on.

- Oven lamp may be faulty. >>> Replace oven's lamp.
- No electricity. >>> Ensure the mains is operational and check the fuses in the fuse box. Change the fuses if necessary or reactivate them.

Oven is not heating.

- The oven may not be set to a specific cooking function and/or temperature. >>> Set the oven to a specific cooking function and/or temperature.
- No electricity. >>> Ensure the mains is operational and check the fuses in the fuse box. Change the fuses if necessary or reactivate them.

Additional Information for User Manual:	Technical information on the operating Low Power Modes pursuant to EU Regulation 2023/826	
Mode	POWER CONSUMPTION(WATT)	PERIOD(MINUTES)*
Off	0,3	-
Standby	-	-
Standby Mode with information or status display	-	-
Networked Standby	-	-

*:The period after which the equipment reaches automatically standby mode, off mode or networked standby in minutes and rounded to the nearest minute.

Technical Specifications

General specifications	
Product external dimensions (height/width/depth) (mm)	595/594/567
Oven installation dimensions (height/width/depth) (mm)	590-600 /560 /min.550
Voltage/Frequency	220-240 V ~; 50/60 Hz
Cable type and section used/suitable for use in the product	min. H05VV-FG 3 x 1,5 mm2
Total power consumption (kW)	2,5
Fuse (min.)	16 A
Oven type	Conventional oven
Energy efficiency class	A
Usable volume (L)	74
Mass of the appliance (M) (Net Weight) kg	27,5
Energy Efficiency Index per cavity EEI cavity	95,3

Basics: Information on the energy label of electrical ovens is given in accordance with the EN 60350-1 / IEC 60350-1 standard. Those values are determined under standard load with bottom-top heater or fan assisted heating (if any) functions. Energy efficiency class is determined in accordance with the following prioritization depending on whether the relevant functions exist on the product or not: 1-Eco fan heating , 2-Fan Heating , 3-Fan assisted low grill , 4-Top and bottom heating.

 Technical specifications may be changed without prior notice to improve the quality of the product.

 Figures in this manual are schematic and may not exactly match your product.

 Values stated on the product labels or in the documentation accompanying it are obtained in laboratory conditions in accordance with relevant standards. Depending on operational and environmental conditions of the product, these values may vary.

Environmental Instructions

Waste Directive

Compliance with the WEEE Directive and Disposing of the Waste Product

This product complies with EU WEEE Directive (2012/19/EU). This product bears a classification symbol for waste electrical and electronic equipment (WEEE).



This product has been manufactured with high quality parts and materials which can be reused and are suitable for recycling. Therefore, do not dispose of the waste product with normal domestic and other wastes at the end of its service life. Take it to a collection point for the recycling of electrical and electronic equipment. You can ask your local administra-

tion about these collection points. Disposing of the appliance properly helps prevent negative consequences for the environment and human health.

Compliance with RoHS Directive:

The product you have purchased complies with EU RoHS Directive (2011/65/EU). It does not contain harmful and prohibited materials specified in the Directive.

DISPOSAL OF PACKAGING MATERIALS

The packaging material is 100% recyclable and is marked with the recycle symbol . The various parts of the packaging must therefore be disposed of responsibly and in full compliance with local authority regulations governing waste disposal.

DISPOSAL OF HOUSEHOLD APPLIANCES

This appliance is manufactured with recyclable or reusable materials. Dispose of it in accordance with local waste disposal regulations. For further information on the treatment, recovery and recycling of household electrical appliances, contact your local authority, the collection service for household waste or the store where you purchased the appliance. This appliance is marked in compliance with European Directive 2012/19/EU, Waste Electrical and Electronic Equipment (WEEE) and with the Waste Electrical and Electronic Equipment regulations 2013 (as amended). By ensuring this product is disposed of correctly, you will help prevent negative consequences for the environment and human health.

The  symbol on the product or on the accompanying documentation indicates that it should not be treated as domestic waste but must be taken to an appropriate collection center for the recycling of electrical and electronic equipment.

ENERGY SAVING TIPS

Only preheat the oven if specified in the cooking table or your recipe.

Use dark lacquered or enamelled baking trays as they absorb heat better.



Food requiring prolonged cooking will continue to cook even once the oven is switched off.

IKEA guarantee

How long is the IKEA guarantee valid?

This guarantee is valid for **five (5) years** from the original date of purchase of your appliance at IKEA. The original sales receipt is required as proof of purchase. If service work is carried out under guarantee, it will not extend the guarantee period for the appliance.

Which LAGAN appliances are not covered by the IKEA 5-year guarantee?

LAGAN appliances purchased from IKEA before 1 May 2026 are covered by a 2-year guarantee, starting from the original date of purchase.

Who will execute the service?

IKEA service provider will provide the service through its own service operations or authorized service partner network.

What does this guarantee cover?

Make sure the oven door is closed completely when the appliance is turned on and keep it closed as much as possible while baking.

Cut the food into small, equally-sized pieces to reduce cooking time and save energy.

When the cooking time is long, over 30 minutes, reduce the oven temperature to the lowest setting during the last phase (3-10 minutes), based on the overall cooking time. The residual heat inside the oven will continue cooking the food.

DECLARATIONS OF CONFORMITY

This appliance meets: Ecodesign requirements of European Regulation 66/2014; Energy Labelling Regulation 65/2014; Ecodesign for Energy-Related Products and Energy Information (Amendment) (EU Exit) Regulations 2019, in compliance with the European standard EN 60350-1.

This product can contain halogen light (Energy Efficiency Class G) or LED light source (Energy Efficiency Class F).

Package Information

Packaging materials of the product are manufactured from recyclable materials in accordance with our National Environment Regulations. Do not dispose of the packaging waste with the household or other wastes, take it to the packaging material collection points designated by the local authorities.

Recommendations for Energy Saving

According to EU 66/2014, information on energy efficiency can be found on the product receipt supplied with the product.

The following suggestions will help you use your product in an ecological and energy-efficient way:

- Defrost frozen food before baking.
- In the oven, use dark or enamelled containers that transmit heat better.
- If specified in the recipe or user's manual, always preheat. Do not open the oven door frequently during baking.
- Turn off the product 5 to 10 minutes before the end time of baking in prolonged bakings. You can save up to 20% electricity by using residual heat.
- Try to cook more than one dish at a time in the oven. You may cook at the same time by placing two cookers on the wire rack. In addition, if you cook your meals one after the other, it will save energy because the oven will not lose its heat.

The guarantee covers faults of the appliance, which have been caused by faulty construction or material faults from the date of purchase from IKEA. This guarantee applies to domestic use only. The exceptions are specified under the headline "What is not covered under this guarantee?" Within the guarantee period, the costs to remedy the fault e.g. repairs, parts, labour and travel will be covered, provided that the appliance is accessible for repair without special expenditure. On these conditions the EU guidelines (Nr. 99/44/EG) and the respective local regulations are applicable. Replaced parts become the property of IKEA.

What will IKEA do to correct the problem?

IKEA appointed Service Provider will examine the product and decide, at its sole discretion, if it is covered under this guarantee. If considered covered, IKEA Service Provider or its authorized service partner through its own service opera-

tions, will then, at its sole discretion, either repair the defective product or replace it with the same or a comparable product.

What is not covered under this guarantee?

- Normal wear and tear.
- Deliberate or negligent damage, damage caused by failure to observe operating instructions, incorrect installation or by connection to the wrong voltage, damage caused by chemical or electrochemical reaction, rust, corrosion or water damage including but not limited to damage caused by excessive lime in the water supply, damage caused by abnormal environmental conditions.
- Consumable parts including batteries and lamps.
- Non-functional and decorative parts which do not affect normal use of the appliance, including any scratches and possible color differences.
- Accidental damage caused by foreign objects or substances and cleaning or unblocking of filters, drainage systems or soap drawers.
- Damage to the following parts: ceramic glass, accessories, crockery and cutlery baskets, feed and drainage pipes, seals, lamps and lamp covers, screens, knobs, casings and parts of casings. Unless such damages can be proved to have been caused by production faults.
- Cases where no fault could be found during a technician's visit.
- Repairs not carried out by our appointed service providers and/or an authorized service contractual partner or where non-original parts have been used.
- Repairs caused by installation which is faulty or not according to specification.
- The use of the appliance in a non-domestic environment i.e. professional use.
- Transportation damages. If a customer transports the product to his home or another address, IKEA is not liable for any damage that may occur during transport. However, if IKEA delivers the product to the customer's delivery address, then damage to the product that occurs during this delivery will be covered by IKEA.
- Cost for carrying out the initial installation of the IKEA appliance. However, if an IKEA appointed Service Provider or its authorized service partner repairs or replaces the appliance under the terms of this guarantee, the appointed Service Provider or its authorized service partner will reinstall the repaired appliance or install the replacement, if necessary. These restrictions do not apply to fault-free work carried out by a qualified specialist using our original parts in order to adapt the appliance to the technical safety specifications of another EU country.

How country law applies

The IKEA guarantee gives you specific legal rights, which cover or exceed all the local legal demands. However these conditions do not limit in any way consumer rights described in the local legislation.

Area of validity

For appliances which are purchased in one EU country and taken to another EU country, the services will be provided in the framework of the guarantee conditions normal in the new country.

An obligation to carry out services in the framework of the guarantee exists only if the appliance complies and is installed in accordance with:

- the technical specifications of the country in which the guarantee claim is made;
- the Assembly Instructions and User Manual Safety Information.

The dedicated AFTER SALES for IKEA appliances

Please don't hesitate to contact IKEA appointed After Sales Service Provider to:

- make a service request under this guarantee;
- ask for clarifications on installation of the IKEA appliance in the dedicated IKEA kitchen furniture;
- ask for clarification on functions of IKEA appliances.

To ensure that we provide you with the best assistance, please read carefully the Assembly Instructions and/or the User Manual before contacting us.

How to reach us if you need our service used.



You can find phone numbers of the IKEA appointed After Sales Service Providers at the end of this manual.

i In order to provide you with a quicker service, we recommend that you use the specific phone numbers listed in this manual. Always use the phone numbers listed in the user manual for the specific appliance you need an assistance for. Please remember to provide the 8-digit article number and 22-digit serial number shown on the rating plate of your appliance.

SAVE THE SALES RECEIPT!

It is your proof of purchase and required for the guarantee to apply. The sales receipt also reports the IKEA name and article number (8 digit code) for each of the appliances you have purchased.

Do you need extra help?

For any additional questions not related to After Sales of your appliances please contact your nearest IKEA store call centre. We recommend you read the appliance documentation carefully before contacting us.

Spare parts information

- The following spare parts: thermostats, temperature sensors, printed circuit boards and light sources, will be available to professional repairers for a minimum period of seven years, after placing the last unit of the model on the market.
- The following spare parts: door handles, door hinges, trays and baskets will be available to professional repairers and end users for a minimum period of seven years, and door gaskets for a minimum period of 10 years, after placing the last unit of the model on the market.

The spare parts can be found: www.ikea.com



BELGIË - BELGIQUE - BELGIEN

Telefoon/Numéro de téléphone/Telefon-Nummer: 026200311
Tarief/Tarif/Tarif: Lokaal tarief/Prix d'un appel local/Ortstarif
Openingstijd: Maandag - Vrijdag 8.00 - 20.00
Heures d'ouverture: Lundi - Vendredi 8.00 - 20.00
Öffnungszeiten: Montag - Freitag 8.00 - 20.00

БЪЛГАРИЯ

Телефонен номер: 0700 100 68
Тарифа: Локална тарифа
Работно време: понеделник - петък 8.00 - 20.00

ČESKÁ REPUBLIKA

Telefonní číslo: 225376400
Sazba: Místní sazba
Pracovní doba: Pondělí - Pátek 8.00 - 20.00

DANMARK

Telefonnummer: 70150909
Takst: Lokal takst
Åbningstid: Mandag - fredag 9.00 - 20.00
Lørdag (Åbent udvalgte søndage, se IKEA.dk) 9.00 - 18.00

DEUTSCHLAND

Telefon-Nummer: 06929993602
Tarif: Ortstarif
Öffnungszeiten: Montag - Freitag 8.00 - 20.00

ΕΛΛΑΔΑ

Τηλεφωνικός αριθμός: 2109696497
Χρέωση: Τοπική χρέωση
Ώρες λειτουργίας: Δευτέρα - Παρασκευή 8.00 - 20.00

ESPAÑA

Teléfono: 913754126 (España Continental)
Tarifa: Tarifa local
Horario: Lunes - Viernes 8.00 - 20.00

EESTI - LATVIJA - CYPRUS

<http://www.ikea.com>

FRANCE

Numéro de téléphone: 0170480513
Tarif: Prix d'un appel local
Heures d'ouverture: Lundi - Vendredi 9.00 - 21.00

HRVATSKA

Broj telefona: 0800 3636
Tarifa: Lokalna tarifa
Radno vrijeme: Ponedjeljak - Petak 8.00 - 20.00

ÍSLAND

Símanúmer: 5852409
Kostnaður við símtal: Almennt mínútuverð
Opnunartími: Mánudaga - Föstudaga 9.00 - 17.00

ITALIA

Telefono: 0238591334
Tariffa: Tariffa locale
Orari d'apertura: Lunedì - Venerdì 8.00 - 20.00

LIETUVIJA

Telefono numeris: (0) 520 511 35
Skambučio kaina: Vietos mokėstis
Darbo laikas: Nuo pirmadienio iki penktadienio 8.00 - 20.00

LUXEMBOURG

Numéro de téléphone: 035220882569
Tarif: Prix d'un appel local
Heures d'ouverture: Lundi - Vendredi 8.00 - 18.00

MAGYARORSZÁG

Telefon szám: (06-1)-3285308
Tarifa: Helyi tarifa
Nyitvatartási idő: Hétfőtől Péntekig 8.00 - 20.00

NORGE

Telefon nummer: 23500112
Takst: Lokal takst
Åpningstider: Mandag - fredag 8.00 - 20.00

NEDERLAND

Telefoon: 0900-235 45 32 en/of 0900 BEL IKEA 0031-50 316 8772 international
Tarief: Geen extra kosten. Alleen lokaal tarief.
Openingstijd: Maandag t/m - Vrijdag 8.00 - 21.00
Zaterdag 9.00 - 21.00
Zondag / Feestdagen 10.00 - 18.00

ÖSTERREICH

Telefon-Nummer: 013602771461
Tarif: Ortstarif
Öffnungszeiten: Montag - Freitag 8.00 - 20.00

POLSKA

Numer telefonu: 225844203
Stawka: Koszt połączenia według taryfy operatora
Godziny otwarcia: Poniedziałek - Piątek 8.00 - 20.00

PORTUGAL

Telefone: 213164011
Tarifa: Tarifa local
Horário: Segunda - Sexta 9.00 - 21.00

ROMÂNIA

Număr de telefon: 021 4074532
Tarif: Tarif local
Orar: Luni - Vineri 9.00 - 18.00

РОССИЯ

Телефонный номер: 84957059426
Стоимость звонка: Местная стоимость звонка
Время работы: Понедельник - Пятница 9.00 - 21.00
(Московское время)

SCHWEIZ - SUISSE - SVIZZERA

Telefon-Nummer/Numéro de téléphone/Telefono: 0225675345
Tarif/Tarif/Tariffa: Ortstarif/Prix d'un appel local/Tariffa locale
Öffnungszeiten: Montag - Freitag 8.00 - 20.00
Heures d'ouverture: Lundi - Vendredi 8.00 - 20.00
Orario d'apertura: Lunedì - Venerdì 8.00 - 20.00

SLOVENIJA

Telefonska številka: +38618107781
Oceni: Lokalna tarifa
Odpiralni čas: Ponedeljek-Sobota 9:00 - 18:00

SLOVENSKO

Telefónne číslo: (02) 50102658
Cena za hovor: Cena za miestny hovor
Pracovná doba: Pondelok až piatok 8.00 - 20.00

SRBIJA

Broj telefona: 011 7 555 444
stopa: lokalna kurs
Radno vreme: Ponedeljak - subota 9.00 - 20.00
nedelja 9.00 - 18.00

SUOMI

Puhelinnumero: 0981710374
Taxa: Yksikköhinta
Aukioloaika: Maanantaista perjantaihin 8.00 - 20.00

SVERIGE

Telefon nummer: 0775-700 500
Taxa: Lokal samtal
Öppet tider: Måndag - Fredag 8.30 - 20.00
Lördag - Söndag 9.30 - 18.00

UNITED KINGDOM - IRELAND

Phone number: 02076601517
Rate: Local rate
Opening hours: Monday - Friday 8.00am - 6.00pm
Saturday 8.30am - 4.30pm
Sunday 9.30am - 3.30pm

