

KULINARISK

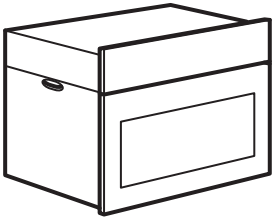

Design and Quality
IKEA of Sweden

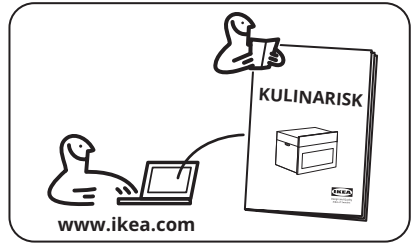
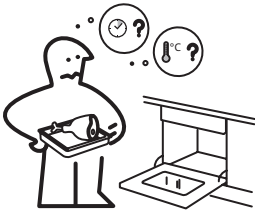

1x

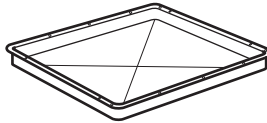

1x



1x



1x

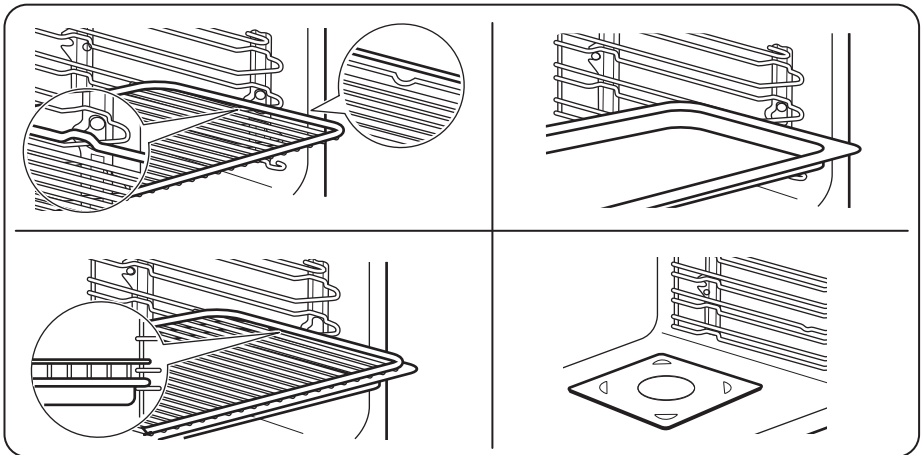

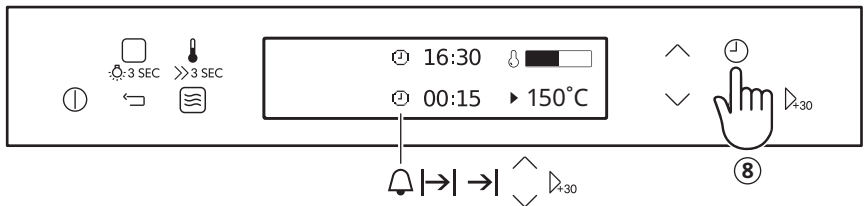
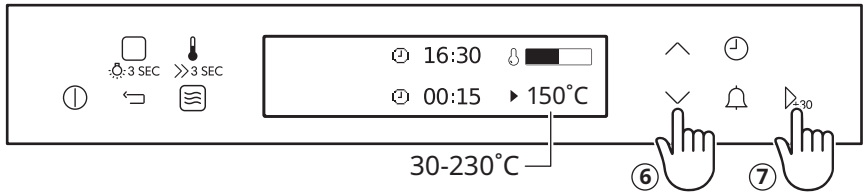
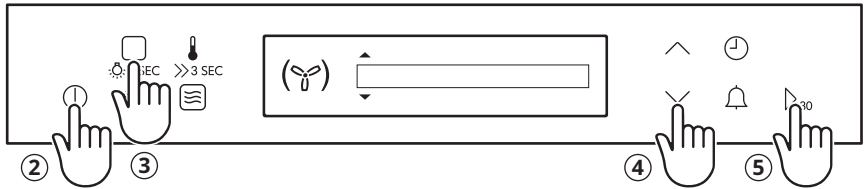
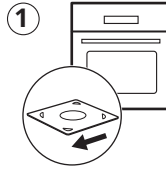
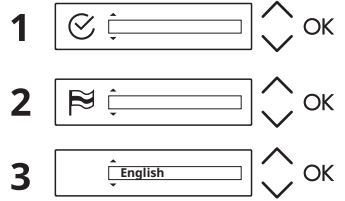
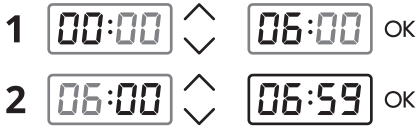
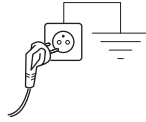

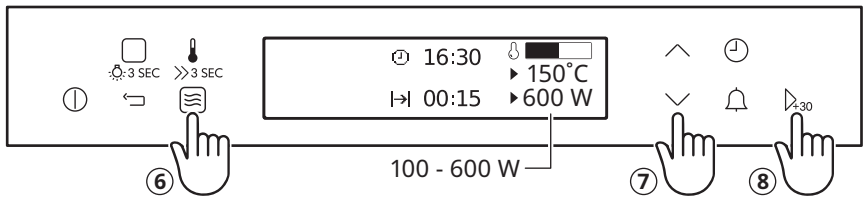
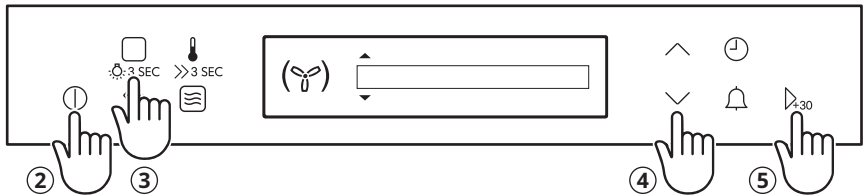
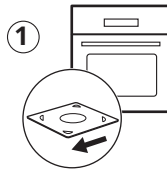
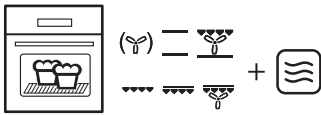
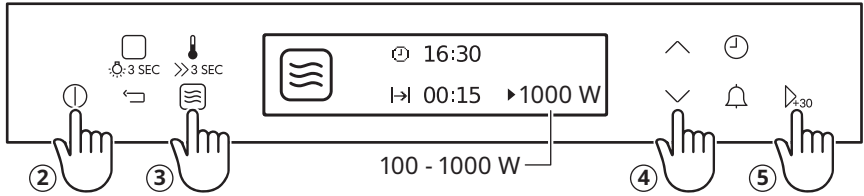
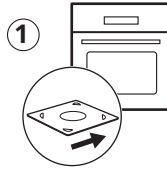

Product Description

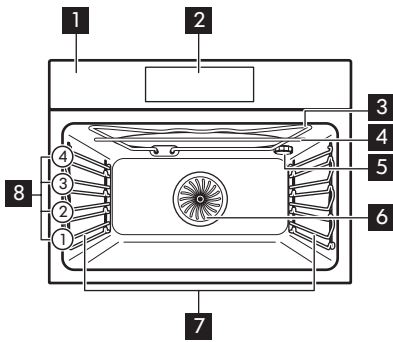

- 1** Control panel
- 2** Electronic programmer
- 3** Grill
- 4** Microwave generator
- 5** Lamp
- 6** Fan
- 7** Shelf support, removable
- 8** Shelf positions

Control Panel

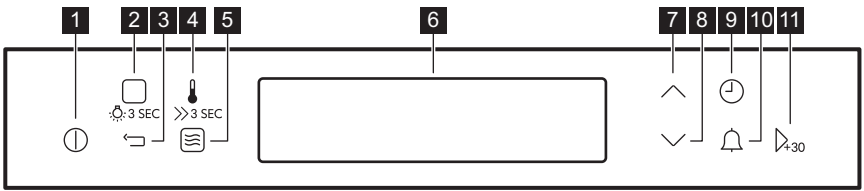

- 1** ON / OFF
- 2** Heating Functions / Assisted Cooking / Lamp
- 3** Back key
- 4** Temperature / Fast Heat Up
- 5** Microwave function
- 6** Display
- 7** Up key
- 8** Down key
- 9** Time / More functions
- 10** Minute minder
- 11** OK / Microwave Quick Start

Display

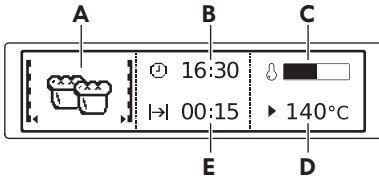

- A. Heating function or Microwave function
- B. Time of day
- C. Heat-up indicator
- D. Temperature or power of the microwave
- E. Duration time or end time of a function

Other indicators of the display:

Symbol	Function
	The function is on.
	Shows current time.
	Shows the necessary time for cooking.
	Shows cooking duration.
	Shows the temperature.
	Shows when the set cooking time ends. Press \checkmark and \wedge at the same time to reset the time.
	Indicates heat level in the oven.
	Shows that Weight Automatic function is on, or that you can change the weight setting
	Heat + Hold is on.

Heating Functions

- True Fan Cooking** Even baking, tenderness, drying
- Conventional Cooking** Traditional baking
- Pizza Function** Baking pizza
- Slow Cooking** For tender roasts
- Bottom Heat** Baking cakes
- Frozen Foods** For convenience food (e.g. french fries)
- Grill** Grilling, toasting
- Fast Grilling** Grilling big portions, toasting
- Turbo Grilling** Roasting meat, browning

Specials

- Bread Baking**
- Dough Proving**
- Preserving**
- Keep Warm**
- Au Gratin**
- Plate Warming**
- Dehydrating**
- Defrost**

Microwave suitable cookware and materials

For the microwave use only suitable cookware and materials. Use below table as a reference.

Check the cookware / material specification before use.

Cookware / Material	Microwave function		Microwave Combi function
	Defrosting	Heating, Cooking	
Ovenproof glass and porcelain with no metal components, e.g. heat-proof glass	✓	✓	✓
Non-ovenproof glass and porcelain without any silver, gold, platinum or other metal decorations	✓	X	X
Glass and glass ceramic made of ovenproof / frost-proof material	✓	✓	✓
Ceramic and earthenware without any quartz or metal components and glazes which contain metal	✓	✓	X
Ceramic, porcelain and earthenware with unglazed bottom or with small holes, e.g. on handles	X	X	X
Heat-resistant plastic up to 200 °C	✓	✓	X
Cardboard, paper	✓	X	X
Clingfilm	✓	X	X
Roasting film with microwave safe closure	✓	✓	X
Roasting dishes made of metal, e.g. enamel, cast iron	X	X	✓
Baking tins, black lacquer or silicon-coated	X	X	✓
Baking tray	X	X	X
Wire shelf	X	X	✓
Microwave glass bottom plate	✓	✓	X
Cookware for microwave use, e.g. crisp pan	X	✓	X

Troubleshooting

If you encounter an issue with your appliance, check "Troubleshooting" chapter

in the full version of the User Manual available on: www.ikea.com.

Technical data

Dimensions (internal)	Width Height Depth	480 mm 217 mm 411 mm
Usable volumes	43 l	
Area of baking tray	1424 cm ²	

Top heating element	1900 W
Bottom heating element	1000 W
Grill	1900 W
Ring	1650 W
Total rating	3000 W
Voltage	230 - 240 V
Frequency	50 Hz
Number of functions	17

867371703-A-222022



© Inter IKEA Systems B.V. 2022

21552

AA-2336061-2