

TORSBODA

en

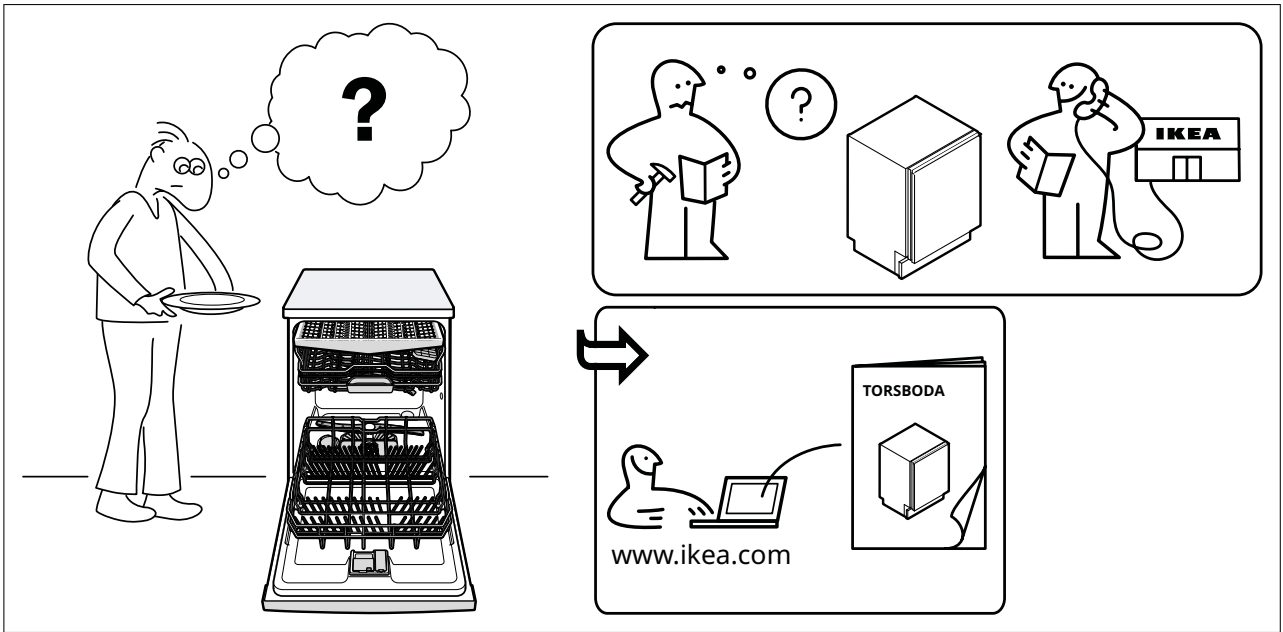

Design and Quality
IKEA of Sweden



1

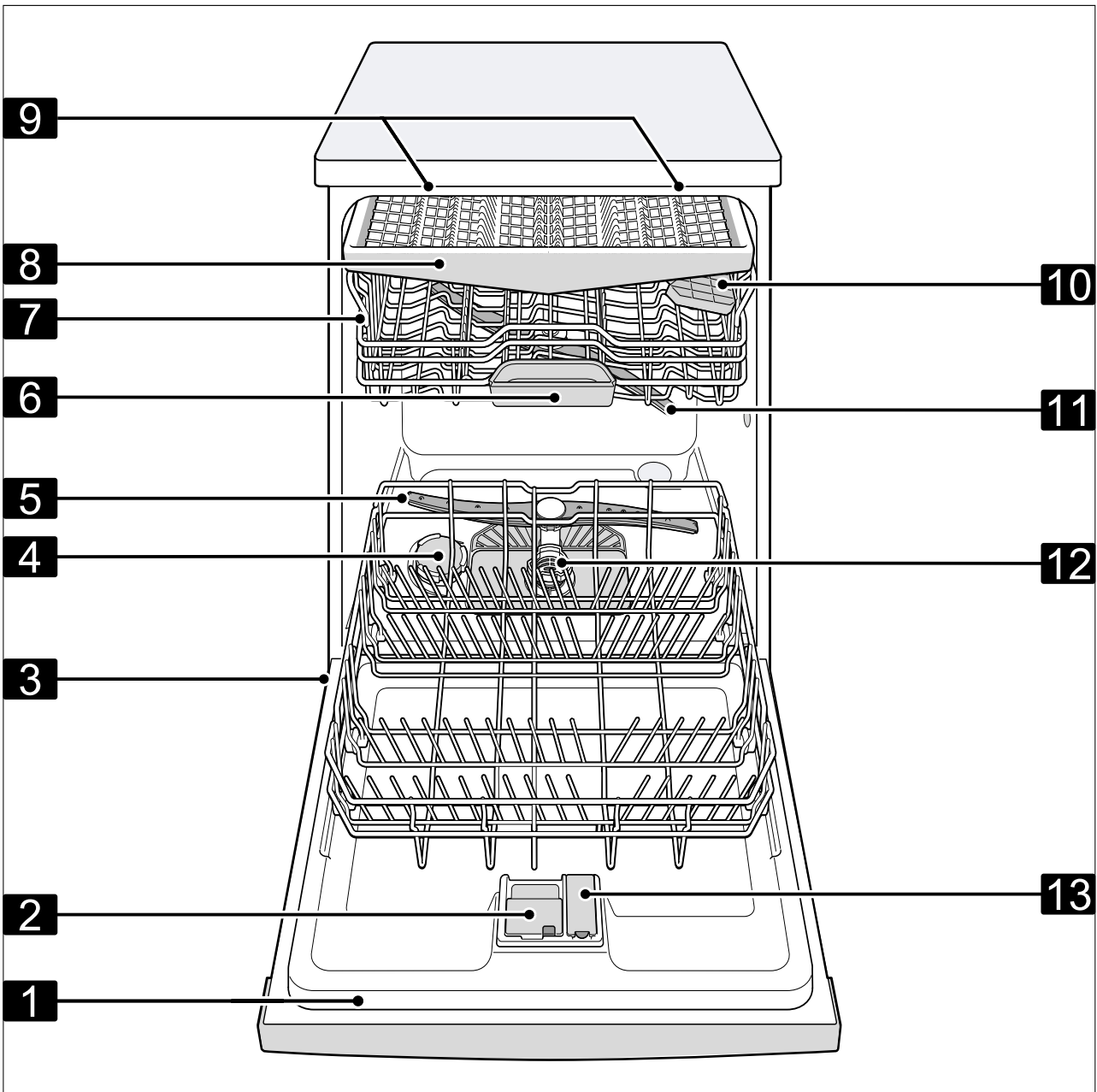

2

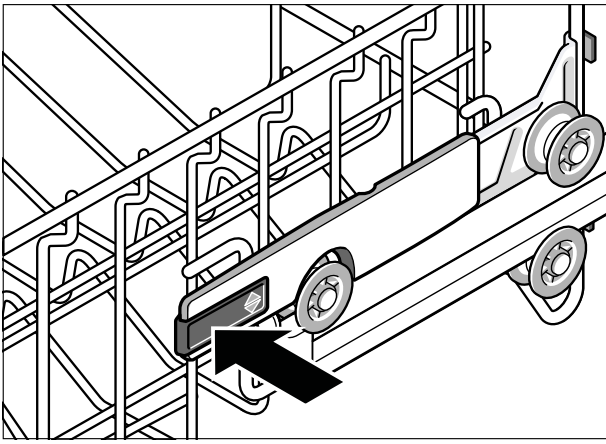

3

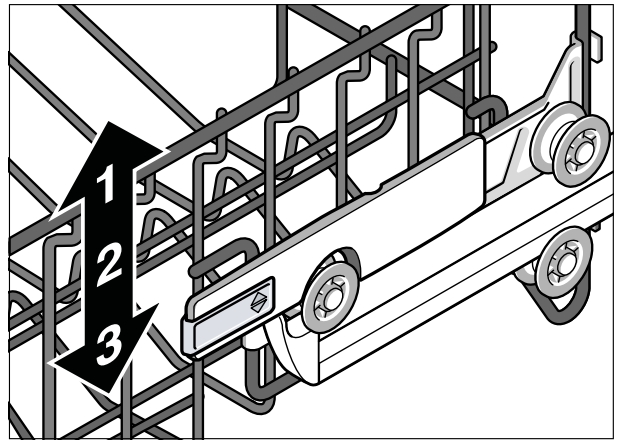

4

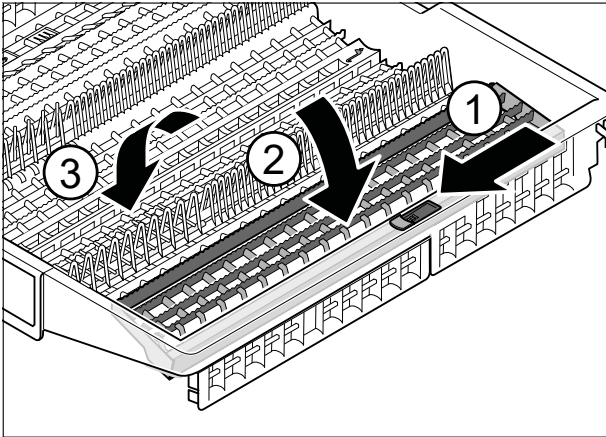

5

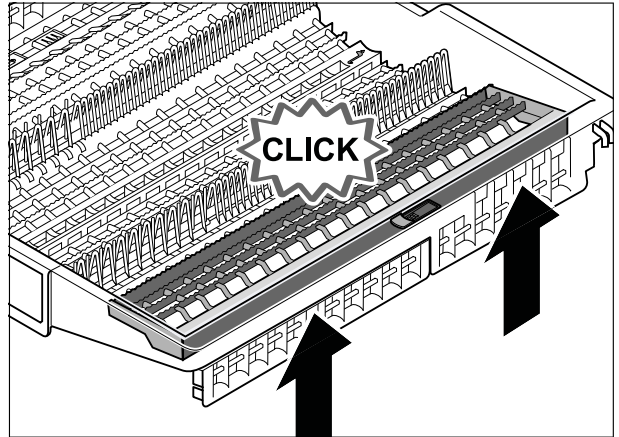

6

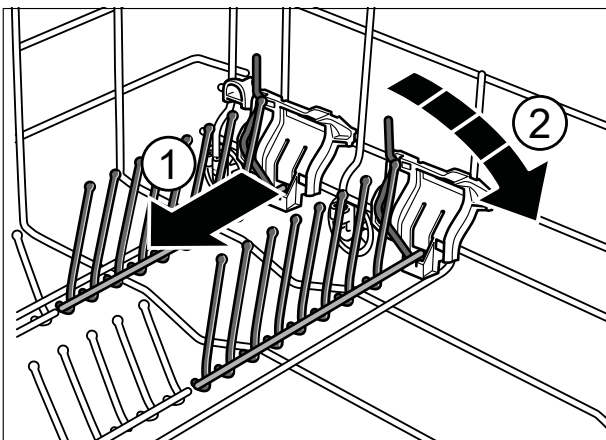

7

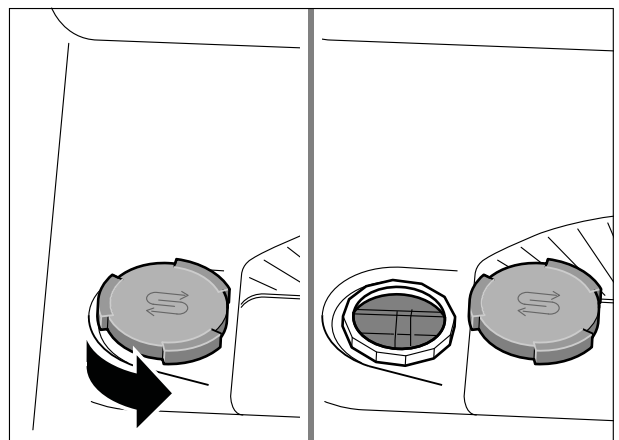

8

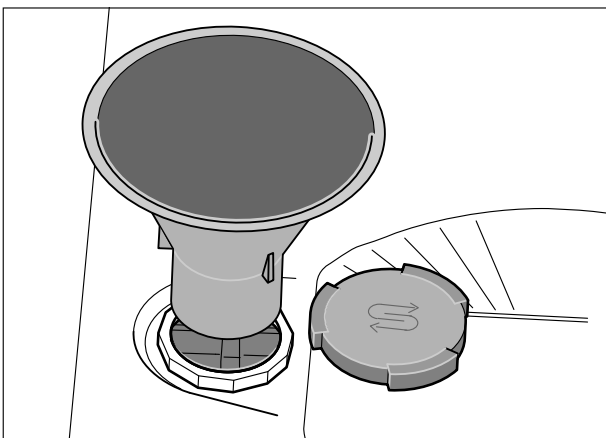

9

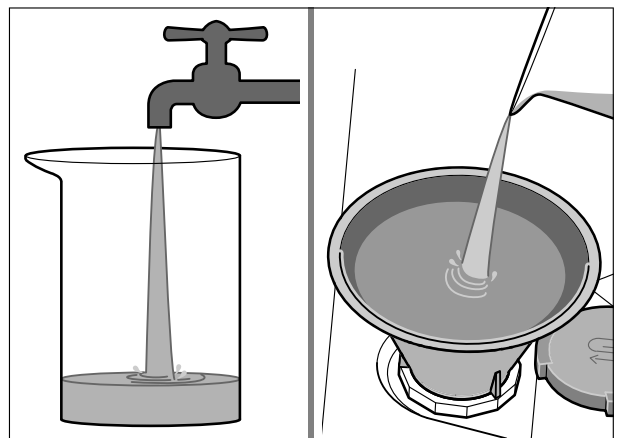

10

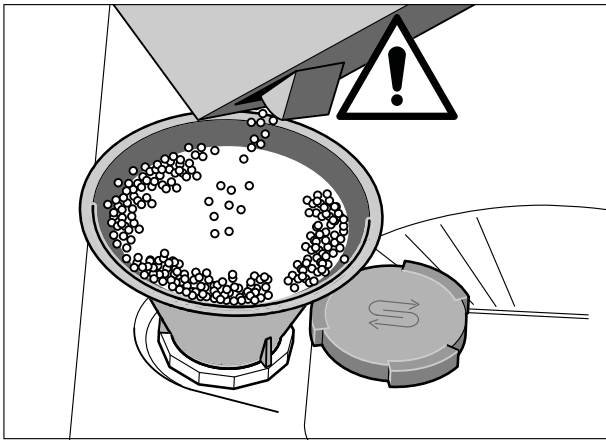

11

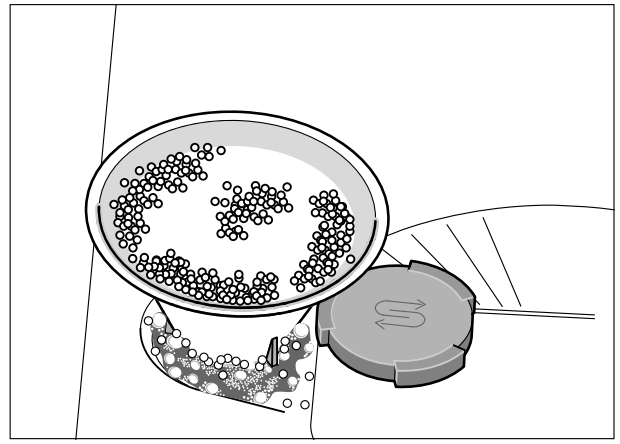

12

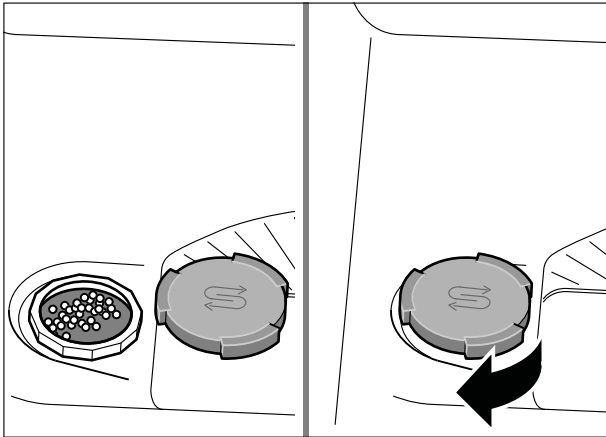

13

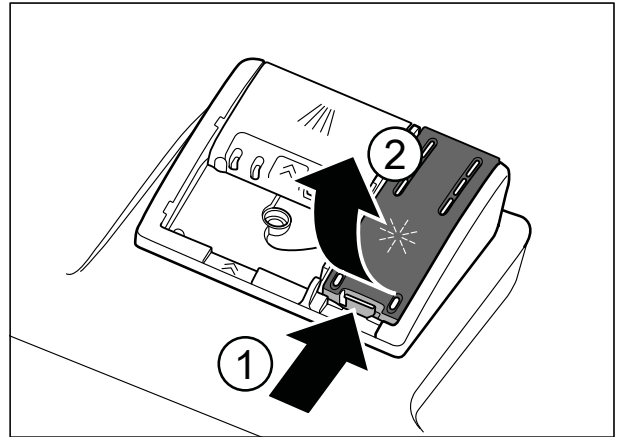

14

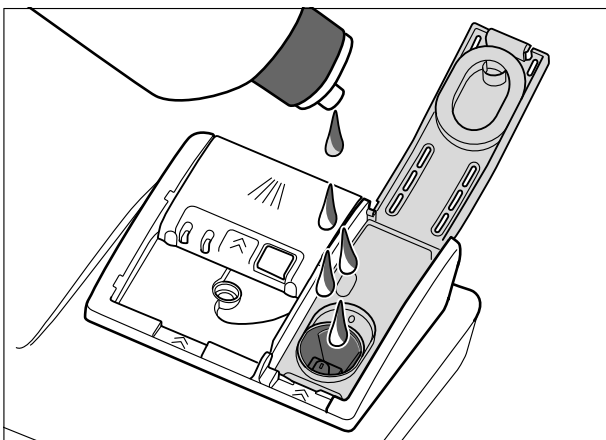

15

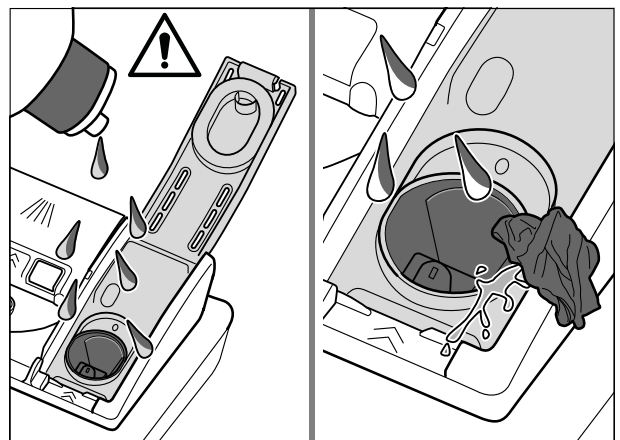

16

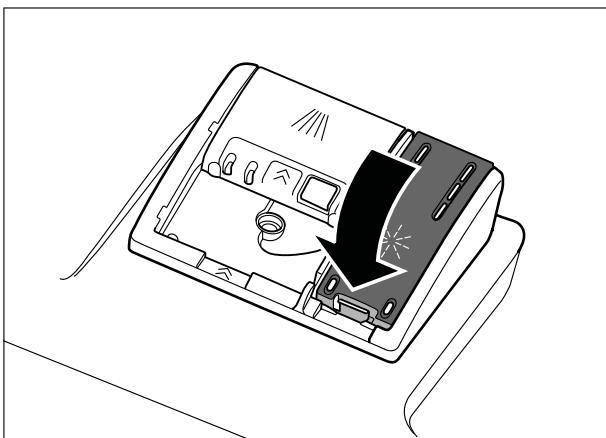

17

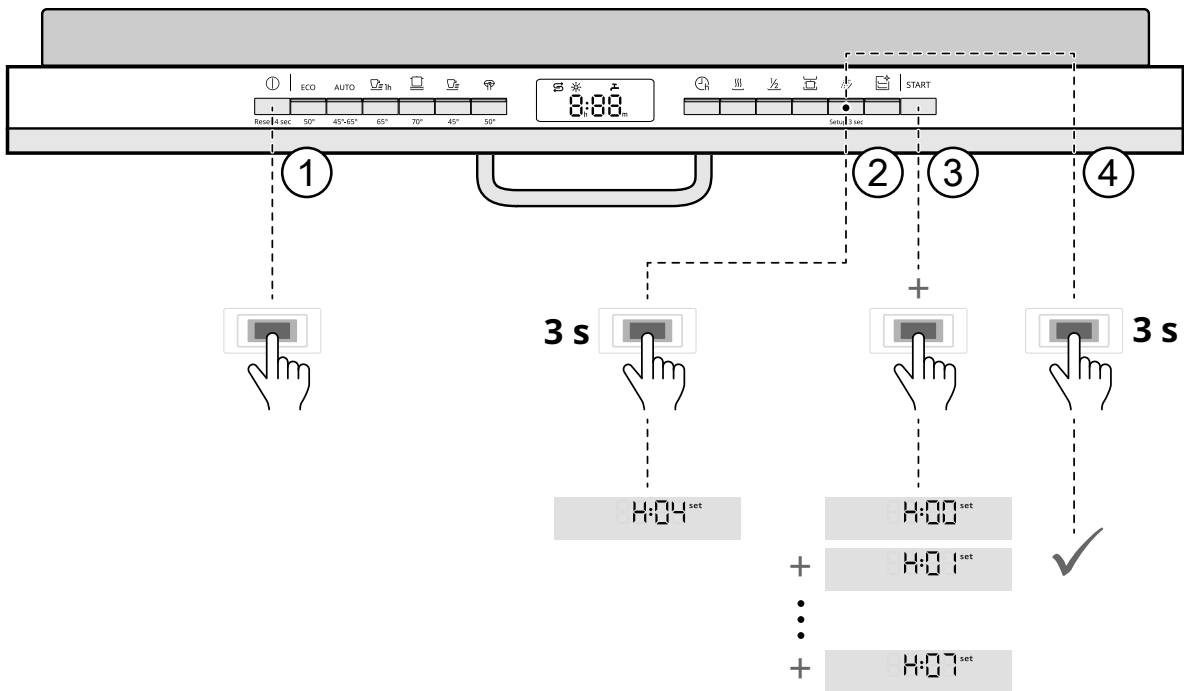

18

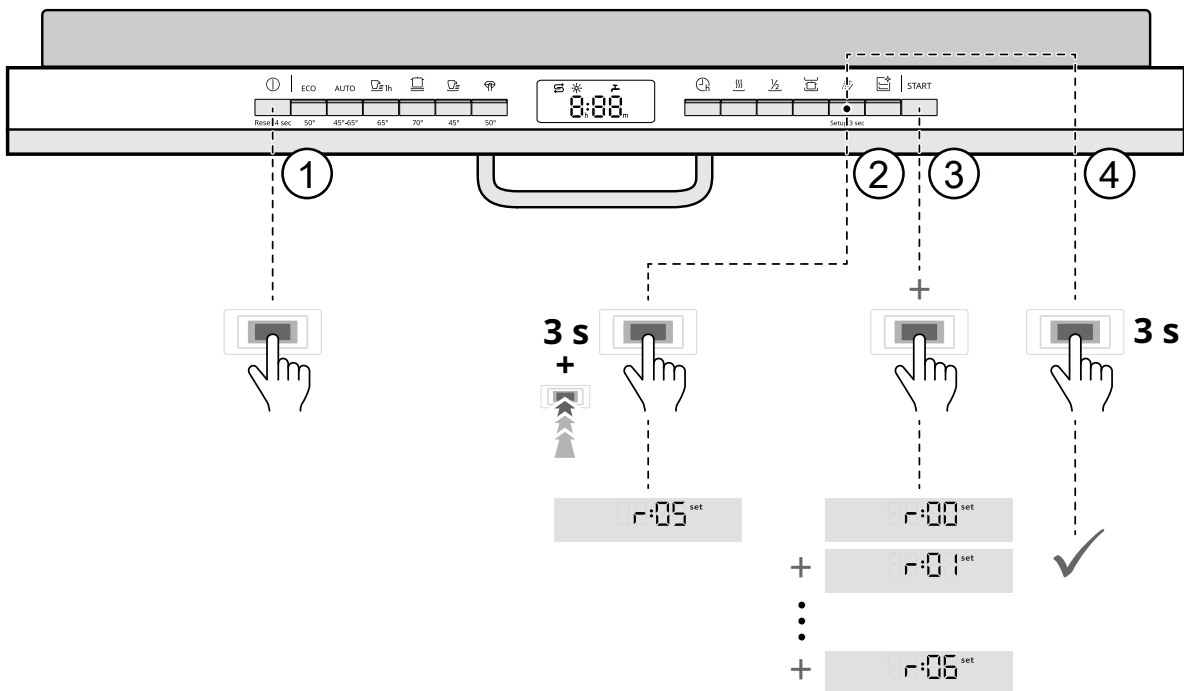

19

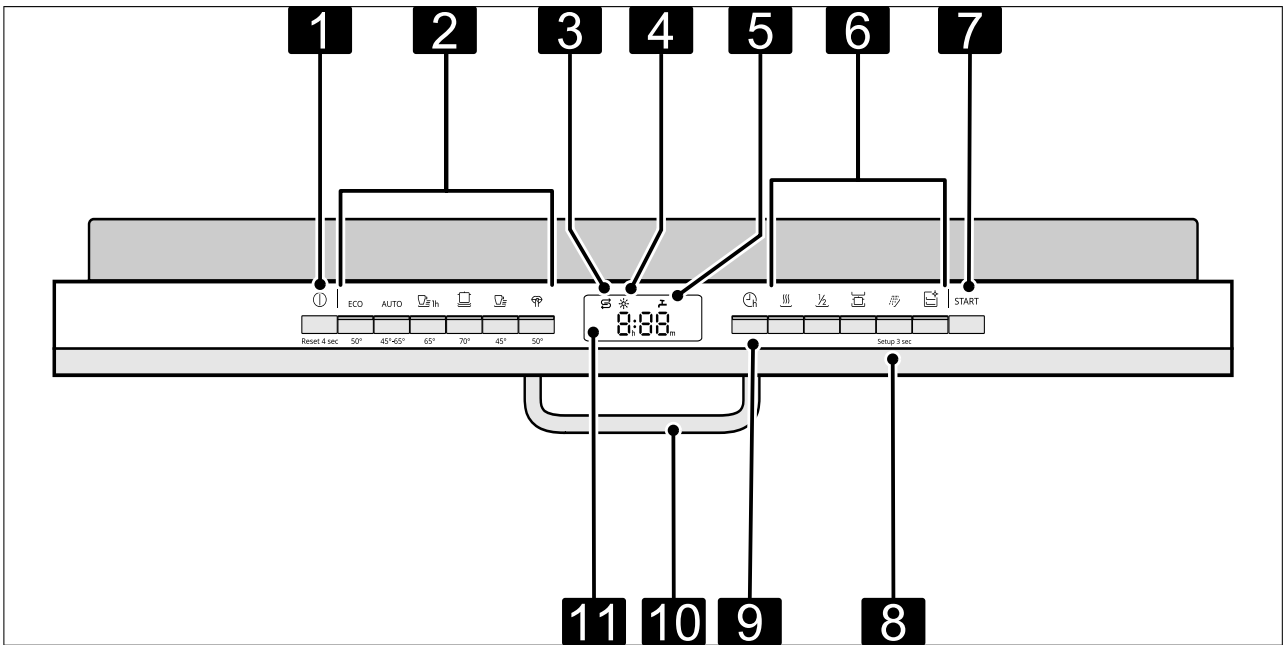

20

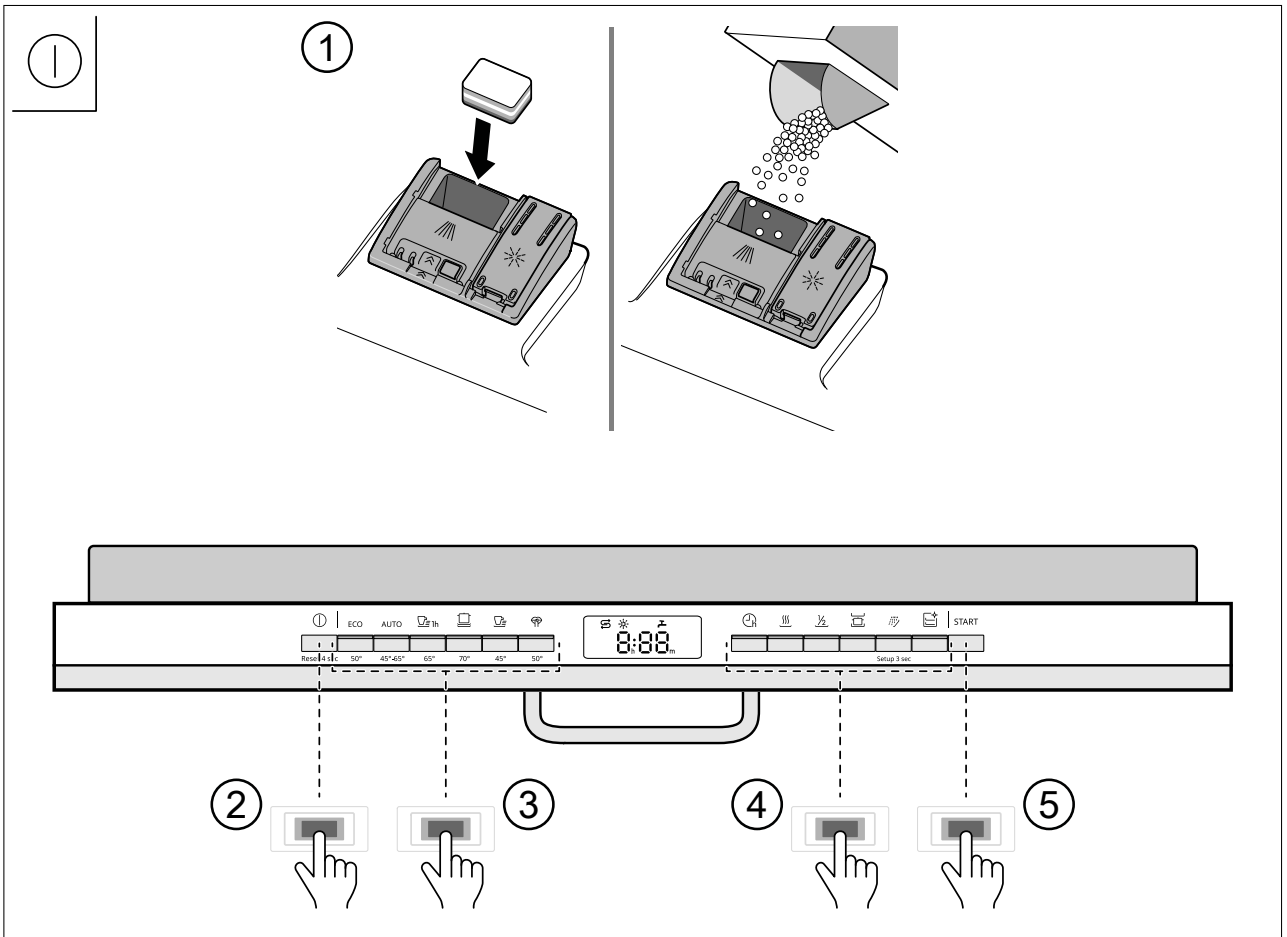

21

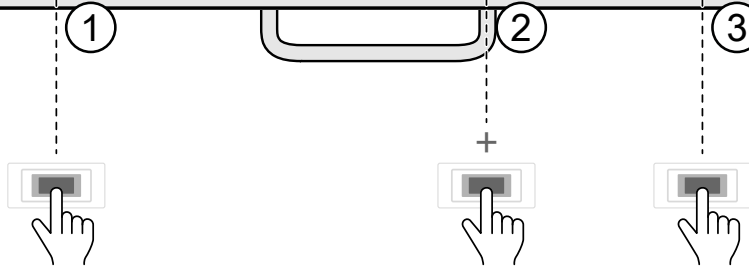
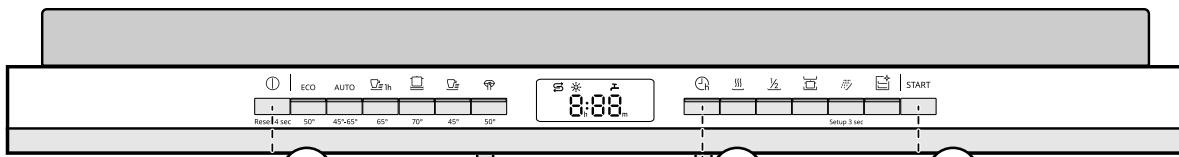

$$\begin{aligned} & \text{h:01}^{\text{set}} = 1 \text{ h} \\ + & \text{h:02}^{\text{set}} = 2 \text{ h} \\ & \vdots \\ + & \text{h:24}^{\text{set}} = 24 \text{ h} \end{aligned}$$

Product information

→ Fig. 1

Product description

Appliance

You can find an overview of the parts of your appliance here.

→ Fig. 2

1	Rating plate	Rating plate with E number and FD number. The data you need for Customer Service.
2	Detergent dispenser	Add detergent to the detergent dispenser.
3	Bottom basket	Bottom basket
4	Dispenser for special salt	Add the special salt to the dispenser for special salt.
5	Lower spray arm	The lower spray arm washes the tableware in the bottom basket. If the tableware has not been washed properly, clean the spray arms.
6	Tablet collecting tray	During the wash cycle tablets automatically fall out of the detergent dispenser into the tablet collecting tray where they can fully dissolve.
7	Top basket	Top basket
8	Cutlery drawer	Cutlery drawer
9	EmotionLight	Interior lighting of the appliance.
10	Cutlery shelf	Cutlery shelf
11	Upper spray arm	The upper spray arm washes the tableware in the top basket. If the tableware has not been washed properly, clean the spray arms.
12	Filter system	Filter system
13	Dispenser for rinse aid	Add rinse aid to the dispenser for rinse aid.

Features

You can find an overview of the possible features of your appliance and how to use them here. These features depend on the model of your appliance.

Adjusting top basket with side levers

To wash large items of tableware in the baskets, adjust the shelf position of the top basket.

→ Fig. 3 - 4

Reorganising cutlery drawer

You can fold down the side shelves and front prongs to make more space for longer/wider items of cutlery.

→ Fig. 5 - 6

Folding down prongs

If you do not need the folding tines, fold them down.

→ Fig. 7

Before first use

Performing the initial configuration

On initial start-up or after a reset to the factory settings, you will need to make settings.

Requirement: The appliance has been installed and connected.

1. Add special salt.
2. Add rinse aid.
3. Switch on the appliance.
4. Setting the water softening system.
5. Set the amount of rinse aid to be dispensed.
6. Add detergent.

7. Start the Programme with the highest cleaning temperature without tableware.

We recommend you clean the appliance without tableware before using it for the first time to remove any marks from water or other residues.

Tip: You can change these settings and other Basic settings at any time.

Adding special salt

If the special salt refill indicator lights up, add special salt to the dispenser for special salt just before the programme starts.

ATTENTION!

- Detergent may damage the water softening system.
 - Only fill the dispenser of the water softening system with special dishwasher salt.
- Special salt can damage the tub due to corrosion.
 - To make sure that any special salt that escapes is washed out of the tub, add the special salt to the dispenser for special salt immediately before the programme starts.

→ Fig. 8 - 13

Overview of water hardness settings

You can find an overview of the water hardness values that can be selected here.

WATER HARDNESS °E	HARDNESS RANGE	MMOL/L	SETTING VALUE
0 - 8	Soft	0 - 1.1	H00
9 - 10	Soft	1.2 - 1.4	H01
11 - 12	Medium	1.5 - 1.8	H02
13 - 15	Medium	1.9 - 2.1	H03
16 - 20	Medium	2.2 - 2.9	H04
21 - 26	Hard	3.0 - 3.7	H05
27 - 38	Hard	3.8 - 5.4	H06
39 - 62	Hard	5.5 - 8.9	H07

Regeneration of the water softening system – overview

In order to ensure fault-free operation of the water softening system, the water softening system is regenerated in all programmes before the end of the main rinse cycle. Here, you can find an overview of the maximum additional running time and consumption values during regeneration of the water softening system. You can find the column applicable to your product variant according to its water consumption in the Eco 50° programme.

Regeneration of the water softening system after x washing programmes	6
Additional running time in minutes	7
Additional water consumption in litres	5
Additional power consumption in kWh	0.05

The consumption values specified are laboratory measurements determined in accordance with the currently applicable standard using the Eco 50° programme and with the factory value of the water hardness set to 16 - 20°E .

Adding rinse aid

If the rinse aid refill indicator lights up, top up with rinse aid. Only use rinse aid for domestic dishwashers.
→ Fig. 14 - 17

Setting water softening system

Set the water hardness on your appliance.
→ Fig. 18

Setting the amount of rinse aid

If there are streaks or water marks on tableware, change the amount of rinse aid.

Note: A low level adds less rinse aid during the wash cycle, a higher setting adds more rinse aid during the wash cycle.

→ Fig. 19

Detergent

Only use detergents that are suitable for dishwashers. Both separate and combined detergents are suitable. For optimum washing and drying results, use separate detergent, adding special salt and rinse aid separately.

Note: Follow the manufacturer's instructions for each detergent.

If you are using tablets, one is enough. Insert the tablets in a horizontal position.

If you are using powder or liquid detergent, follow the manufacturer's instructions and quantities for dosage in the detergent dispenser.

20 ml – 25 ml detergent is sufficient for normal soiling. If tableware is only lightly soiled, slightly less than the amount of detergent specified is usually sufficient.

Control panel

You can use the control panel to configure all functions of your appliance and to obtain information about the operating status.

→ Fig. 20

1	ON/OFF button  and reset button Reset 4 sec.	Switching on the appliance Switching off the appliance Terminating the programme
2	Programme buttons	Programmes
3	Special salt refill indicator	Water softening system
4	Rinse aid refill indicator	Rinse aid system
5	Water supply display	Display for water supply
6	Programme buttons and additional functions	Programmes Additional functions
7	Start button Start	Starting the programme
8	Setup 3 sec. button	If you press Setup 3 sec. for approx. 3 seconds, you can open the basic settings.
9	Timer programming	Setting timer programming
10	Door opener	Opening the appliance door
11	Display	The display shows information about the remaining running time or the basic settings. You can change the basic settings via the display and the setting buttons.

Overview of programmes







You can find an overview of the programmes that can be set here.

Start a programme:

→ Fig. 21

Set the start time for a programme:

→ Fig. 22

PROGRAMME	1) PROGRAMME DURATION IN H:MIN 2) ENERGY CONSUMPTION IN KWH 3) WATER CONSUMPTION IN L	PROGRAMME SEQUENCE
 Intensive 70°	<ul style="list-style-type: none"> • 1) 2:05 - 2:15 • 2) 1.300 - 1.400 • 3) 11.5 - 13.5 	Intensive: <ul style="list-style-type: none"> • Pre-Rinse • Cleaning 70 °C • Intermediate rinse • Final rinse 69 °C • Dry
AUTO Auto 45-65°	<ul style="list-style-type: none"> • 1) 1:40 - 2:45 • 2) 0.900 - 1.500 • 3) 7.0 - 15.5 	Sensor-controlled: <ul style="list-style-type: none"> • Optimised by sensors depending on the soiling level of the washing water
ECO Eco 50°	<ul style="list-style-type: none"> • 1) 4:35 • 2) 0.736 • 3) 9.5 	Most economical: <ul style="list-style-type: none"> • Pre-Rinse • Clean 50 °C • Intermediate rinse • Final rinse 48 °C • Drying
 Quiet 50°	<ul style="list-style-type: none"> • 1) 4:00 • 2) 1.050 • 3) 11.2 	Reduced noise: <ul style="list-style-type: none"> • Pre-Rinse • Cleaning 50 °C • Intermediate rinse • Final rinse 63 °C • Dry
 1h Quick 65°	<ul style="list-style-type: none"> • 1) 1:00 • 2) 1.300 • 3) 10.5 	Time-optimised: <ul style="list-style-type: none"> • Cleaning 65 °C • Intermediate rinse • Final rinse 69 °C • Dry
 Quick 45°	<ul style="list-style-type: none"> • 1) 0:29 • 2) 0.800 • 3) 10.5 	Time-optimised: <ul style="list-style-type: none"> • Cleaning 45 °C • Intermediate rinse • Final rinse 55 °C
 PreRinse	<ul style="list-style-type: none"> • 1) 0:15 • 2) 0.050 • 3) 4.0 	Cold rinse: <ul style="list-style-type: none"> • Pre-rinse
 Machine Care	<ul style="list-style-type: none"> • 1) 2:10 • 2) 1.350 • 3) 15.2 	Use only if appliance is unloaded. Machine Care 70 °C

Information for test institutes



Test institutes are provided with information for comparability tests, e.g. according to EN60436.

These are the conditions for conducting the tests, however they are not the results or consumption values.

E-mail enquiries to: dishwasher@test-appliances.com
The product number (E-Nr.) and the production number (FD) are required here. They can be found on the rating plate on the appliance door.

Additional functions

You can find an overview of the additional functions that can be set here.

ADDITIONAL FUNCTIONS	USE
 Half Load	<ul style="list-style-type: none"> • Switch on with small loads. • It is recommended adding less detergent to the detergent dispenser than for a full machine load. • The run time is shortened. • Energy and water consumption are reduced.
 ExtraDry	<ul style="list-style-type: none"> • For a better drying result the final rinse temperature is increased and the drying phase extended. • Especially suitable for drying plastic parts. • There is a slight increase in energy consumption and the run time is extended.

ADDITIONAL FUNCTIONS	USE
 IntensiveZone	<ul style="list-style-type: none"> • Switch on with mixed loads containing tableware with different soiling levels, e.g. place very soiled pots and pans in the bottom basket and normally soiled tableware in the upper basket. • The spray pressure in the bottom basket is increased and the maximum programme temperature held longer. This will increase the run time and energy consumption.

Handling problems

If you have a problem with your appliance, refer to the "Troubleshooting" section in the full version of the user manual, which is available on the following pages: www.ikea.com.

Technical specifications

Dimensions (HxWxD)	865 x 598 x 550 mm
Weight	Max.: 60 kg
Voltage	220 - 240 V, 50 Hz or 60 Hz
Power rating	2000 - 2400 W
Fuse	10 - 16 A
Water pressure	<ul style="list-style-type: none"> • Min. 0.05 MPa (0.5 bar) • Max. 1 MPa (10 bar)
Inlet rate	Min. 10 l/min
Water temperature	Cold water. Hot water max.: 60 °C
Capacity	13 place settings

More information about your model can be found online at <https://eprel.ec.europa.eu/qr/1790029>. This web address is linked to the official EU EPREL product database.

Note: To save energy and water, load the machine with the maximum number of place settings specified.

Information regarding free and open source software

This product includes software components that are licensed by the copyright holders as free software or open source software.

This licence information can be downloaded via our home page www.ikea.com. Alternatively, you can request relevant information from se.hfb70.running.range@inter.ikea.com. The relevant source code will be made available on request. Please send your request to the above address. Subject: "**FOSS**"



A series of horizontal lines for writing, consisting of 25 evenly spaced lines extending across the width of the page.

