

TÄCKNAN





Please refer to the last page of this manual for the full list of IKEA appointed Authorized Service Centre and relative national phone number.

Contents

Safety information	4	Cookware guidance	20
General information	8	Daily use	21
Electrical connection	10	User menu customisation	24
Cleaning and maintenance	13	Power management	25
Product description	15	Troubleshooting	25
Indicators	15	Extractor technical data	26
Turning on the appliance	16	Extractor energy efficiency	27
Power limitation	16	Hob energy efficiency	28
Control panel	17	Rating plate	28
Cooking zone control panel	18	Environmental aspects	29
Extractor control panel	19	IKEA guarantee	30

Safety information

i For your safety and the correct operation of the device, please read this manual carefully before installation and use. Always keep these instructions with the appliance, even when it is sold or passed on to third parties. It is important that the users are well versed in the operating and safety features of the appliance. The induction system of these hobs complies with the provisions of EMC standards and the EMF directive and should not interfere with other electronic devices. Individuals with pacemakers or other electronic implants should consult their doctor and the manufacturer of the implant to assess whether these devices are sufficiently resistant to interferences.

⚠ The electrical connection must be performed by a specialised technician. Before making the electrical connection, please read the section entitled ELECTRICAL CONNECTION.

For appliances with a power supply cable, the terminals or section of wire between the cable anchor point and the terminals must be laid out so that they allow the live wire to be extracted before the earth wire if it comes loose.

- The manufacturer cannot be held responsible for any damage resulting from incorrect or inadequate installation.
- Check that the mains power supply corresponds to the one indicated on the rating plate affixed to the inside of the product.
- The cut-out devices must be installed in the fixed system according to the wiring system regulations.
- For Class I appliances, check that the domestic power supply has a suitable earthing connection.
- Connect the suction hood to the flue using a suitable pipe. Refer to the purchasable accessories indicated in the installation manual (for circular pipes: minimum diameter 125 mm). The length of the discharge piping must be as short as possible.
- Connect the product to the mains using an omnipolar switch.
- The air venting regulations must be complied with.
- Never connect the suction appliance to ducts carrying combustion fumes (heaters, fireplaces, etc.).
- If the suction hood is used alongside non-electrical appliances (e.g. appliances with gas burners), it is necessary to guarantee a sufficient level of ventilation in the room, to prevent any exhaust backflow. When the cooking appliance is used together with other appliances using non-electrical power sources, the negative pressure in the room must not exceed 4 Pa, to prevent the fumes being sucked back into the room by the cooking appliance.
- The air must not be discharged into a pipe that is also used as a flue for appliances powered by gas or other fuels.
- If the power cable is damaged, it must be replaced by the manufacturer, an authorised service centre or a qualified technician, to avoid any risk of danger.
- Connect the appliance plug to a socket that complies with current regulations and is in an accessible area.

- As regards the technical and safety measures to be taken for exhausting of fumes, it is important that the regulations set by local authorities be followed carefully.

⚠ WARNING: Remove the protective films before installing the appliance.

- Only use the screws and other hardware elements supplied with the appliance.

⚠ WARNING: Failure to install the screws or fixing devices as described in these instructions may lead to a risk of electric shocks.

- Never look at the light directly through optical devices (binoculars, magnifying glasses, etc.).
- Cleaning and maintenance must not be carried out by children, unless they are supervised by an adult.
- Children must be supervised to ensure that they do not play with the appliance.
- This appliance must not be used by persons (including children) with limited physical, sensory or mental abilities, or by inexperienced or untrained persons, unless closely supervised and instructed in the safe use of the appliance by a person responsible for their safety.
- This appliance may be used by children over the age of eight and by persons with limited physical, sensory or mental abilities or with insufficient experience and knowledge, provided they are closely supervised and instructed on the safe use of the appliance and on the dangers that it involves. Do not allow children to play with the appliance.

⚠ WARNING: The appliance and its accessible parts become extremely hot during use.

Take great care not to touch the heating elements.

Keep children under 8 years of age well away from the appliance, unless they are under constant supervision.

- Clean and/or replace the filters after the period indicated (danger of fire). See the paragraph on Cleaning and maintenance.
- Always guarantee adequate ventilation of the room when the appliance is used in conjunction with other appliances powered by gas or other fuels (this does not apply to appliances that only recirculate the air within the room).

 **WARNING:** If the surface shows any signs of cracking, turn the appliance off to prevent any risk of electric shock. The appliance and its accessible parts become extremely hot during use.

- Do not turn the device on if the surface is cracked or any damage is visible in the thickness of the material.
- Do not touch the appliance if your hands or body are wet.
- Do not use steam appliances to clean the product.
- Do not rest metal objects such as knives, forks, spoons and pan lids on the surface of the hob, as they might overheat.
- Use the relevant control to turn the hob off after use; do not rely on the pan indicators.

 **WARNING:** Unsupervised cooking on a hob using oil and grease may be dangerous and could cause a fire. NEVER attempt to put flames out with water. Turn the appliance off and suffocate the flames by covering them with a pan lid or a fire blanket, for example.

•

 **WARNING:** The cooking process must be supervised. A short cooking process must be constantly monitored.

- The appliance is not designed to be started using an external timer or a separate remote-controlled system.

⚠ WARNING: Danger of fire: do not place objects on the cooking surfaces.

- The appliance must be installed to allow it to be cut off from the electrical power supply with a contact opening (3 mm) that ensures complete disconnection under overvoltage category III conditions.
- The appliance must never be exposed to the elements (rain, sun).
- Ventilation of the appliance must comply with the manufacturer's instructions.
- Keep the packaging away from children and animals.
- Kitchen hoods and other cooking fume extractors can affect the safe operation of appliances which burn gas or other fuels (including those in other rooms) due to the backflow of combustion gases. These gases can cause carbon monoxide poisoning. After installing a kitchen extractor hood or any other cooking fume extractor, make sure that the gas appliances are tested by a certified technician to guarantee that there is no backflow of combustion gases.

General information

General recommendations

- Never use abrasive sponges, wire wool, hydrochloric acid or other products that might scratch or mark the surface.
- For safety reasons, do not use steam jet or high-pressure cleaners to clean the appliance.
- Do not consume any food that falls accidentally or is deposited on the surface and on the functional or aesthetic elements of the hob.

Use

- The extractor hood has been designed solely to eliminate cooking fumes during domestic use.
- Never use the appliance for purposes other

than those for which it has been designed.

- Deep fryers must be continuously monitored during use: overheated oil could catch fire.
- Do not operate the appliance using an external timer or separate remote-controlled system.
- The appliance must never be installed behind a decorative door, to prevent it from overheating.
- Never stand on the appliance, as this may damage it.
- Do not rest hot pots and pans on the frame, as this may damage the silicone seals.
- Do not cut or prepare foodstuff on the surface and do not drop hard objects onto it.

Do not drag pans or plates over the surface.

Cabinet requirements

Installation

- The appliance is intended for recessed installation in the kitchen worktop above a cabinet with a width of 800 mm or more.
- If the appliance is installed on flammable materials, it is necessary to strictly comply with the guidelines and regulations regarding low voltage installations and fire protection.
- For fitted units, the components (plastic materials and veneered wood) must be assembled with heat-resistant adhesives (min. 85 °C): Unsuitable materials and adhesives can result in warping and detachment.
- The kitchen cabinet must allow sufficient room for the electrical connections of the appliance. Suspended kitchen cabinets above the appliance must be installed at a distance that provides enough room for comfortable working process.
- The use of hard wood decorative borders around the worktop behind the appliance is allowed, in this case the minimum distance remains as indicated on the installation illustrations.
- Positioning and dimensions of the cut-out for built-in appliance is shown in the illustration below.

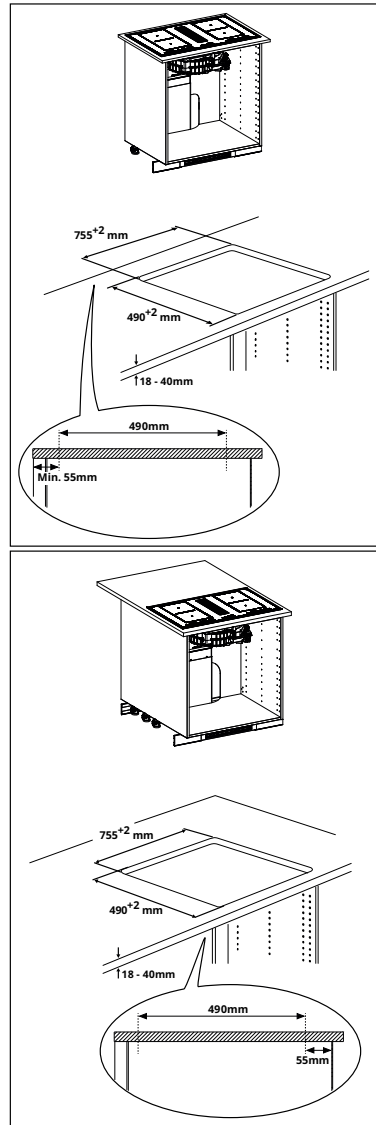

- Minimum distance between built-in appliance and any cabinet above is 500mm.

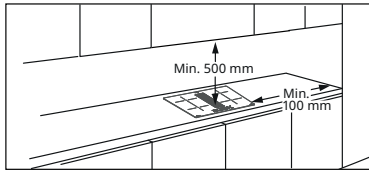

- To complete the installation of the filter, refer to the NYTTIG kit.

Electrical connection

- All electrical connections must be carried out by an authorised installer.
- Follow the connection diagram (on the under side of the product).
- This appliance has a Y-type connection and requires a mains cable H05VV-F. Cable needs mandatory sleeves. According to IEC

regulations use for one-phase connection: mains cable $3 \times 4 \text{ mm}^2$, for two-phase connection: mains cable $4 \times 2.5 \text{ mm}^2$ and for NL connection: mains cable $5 \times 2.5 \text{ mm}^2$. External cable diameter: min 8 mm - max 12 mm. Please respect specific national regulations in the first priority.

- The connection terminals can be accessed by removing the junction box cover.
- Check that the domestic power supply characteristics (voltage, maximum power and current) are compatible with those of the appliance.
- Connect the appliance as shown in the diagram (in compliance with reference standards in force nationally for mains voltage).
- Do not weld any of the cables!

Electrical connection



WARNING: All electrical connections must be carried out by an authorised electrician.

- Before making the connections, check that the rated voltage of the appliance indicated on the rating plate corresponds to the mains power supply. The rating plate is affixed to the underside of the hob.
- Observe the wiring diagram (located underneath the hob).
- Only use original components supplied by the spare parts service.
- The appliance is not equipped with a net-

work cable. Purchase the correct one from a specialist dealer.

- If the cables are damaged, replace with original spare parts cables. Contact the call center of your IKEA store.



Attention! Do not weld any of the cables!

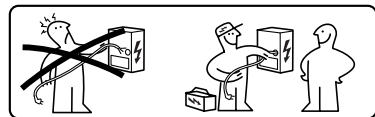

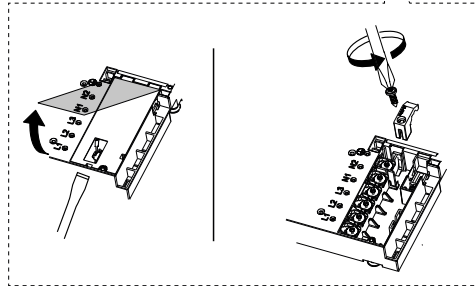
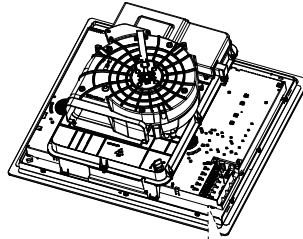

Connection diagram product side

Insert the shunts  between the screws as illustrated

380V - 415V 2N ~

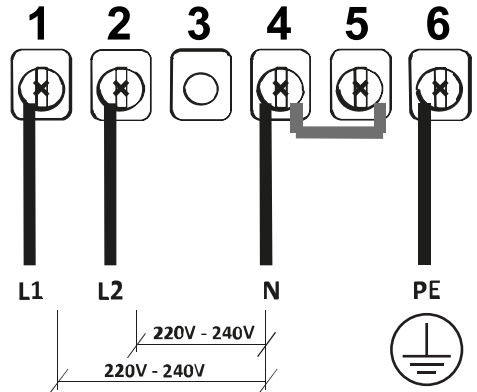

220V - 240V 1N ~

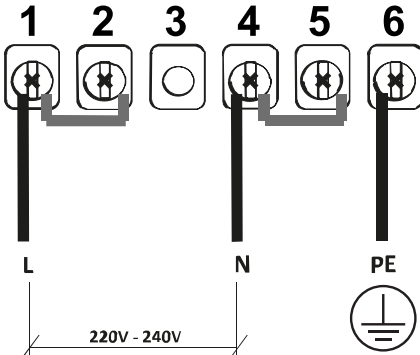

L	Black or brown
N	Blue
	Yellow / Green

L1	Brown
L2	Black
N	Blue
	Yellow / Green

Connection diagram home side

220V - 240V 1N ~

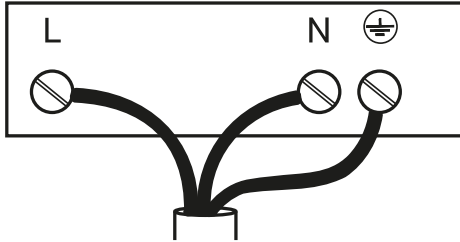

L	Black or brown
N	Blue
⊕	Yellow / Green

380V - 415V 2N ~

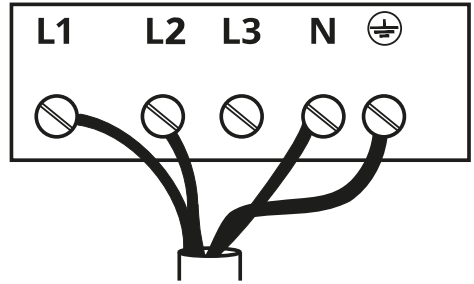

L1	Brown
L2	Black
N	Blue
⊕	Yellow / Green

Cleaning and maintenance

- Switch the appliance off or disconnect it from the electricity supply before any maintenance work.

Activated charcoal filter

- The Activated Charcoal odour filter (please refer to the assembly instructions) is neither washable nor regenerable, it must be replaced every 12 months. To order a new filter, please contact the after-sales service (see the table at the end of the manual).

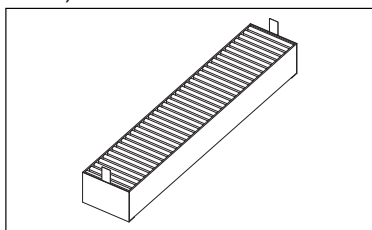

Grid

- Do not wash in the dishwasher. Clean the grid with warm water and mild soap, without using abrasive sponges (do not use aggressive or abrasive detergents!).

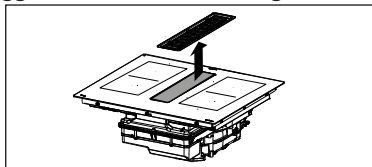

Grease filter

- Clean or replace the filters continuously according to below time intervals, to maintain good performance of the hood and to prevent a potential fire hazard, caused by excessive grease build-up.
- The grease filters must be cleaned every 2 months of operation, or more frequently for particularly heavy usage, and can be washed in a dishwasher.

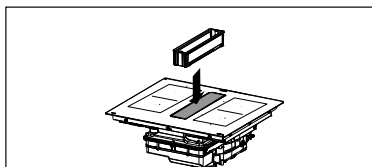

The upper overflow tray is part of the grease filter and must be inspected after every cooking cycle or every time you notice that liquid has spilled onto the hob. Wash with hot water and remove any food residue to prevent odours and deposits from forming.

Liquid drip container

During normal use, it is advisable to check and empty the drip container every two weeks.

Remove the drawer before checking the drip container, especially if there are large amounts of spilt liquid. Press the tap (orange) upwards and unscrew it to empty the container. After emptying the water drip container, screw the tap (orange) back in upwards until it is closed.

The valve can be replaced if lost or damaged, and it can be purchased as a spare part.

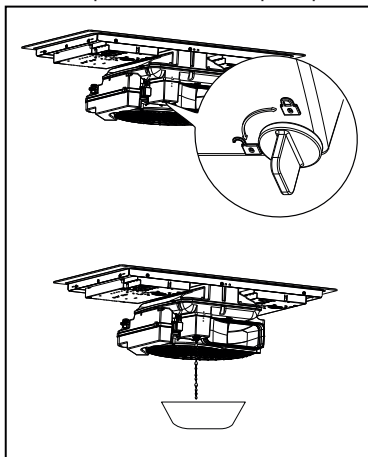

Removing the liquid drip container

For more thorough cleaning, especially if liquids that could cause bad odours spill, detach the container by opening the indicated hook.

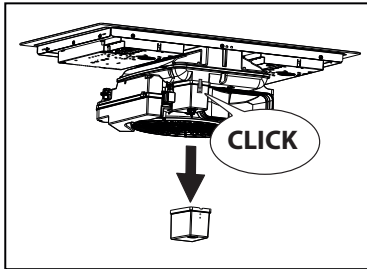

Emptying the plastic motor box

If more than 1 litre of liquid is spilt onto the hob, unscrew the screw cap (orange) as indicated and empty the motor box. After emptying the box, screw the tap (orange) back in upwards until it is closed. The valve can be replaced if lost or damaged, and it can be purchased as a spare part.

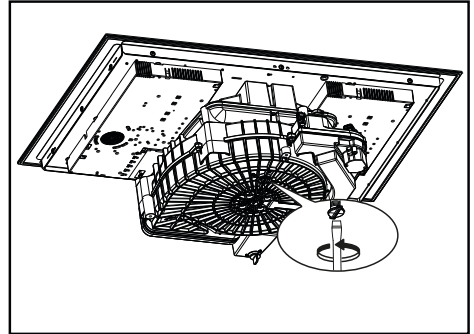

Cleaning the appliance

Clean the appliance after every use to prevent any residual food from getting burned on it. It is much harder work to remove encrusted and burnt-on dirt.

- For day-to-day dirt, use a soft cloth or sponge and a suitable detergent. Follow the manufacturer's recommendations regarding detergents to be used. The use of protective detergents is recommended.
- Remove limescale using a small amount of limescale remover solution, for example vinegar or lemon juice, once the cooker hob has cooled down. Then, clean again with a damp cloth.

Product description

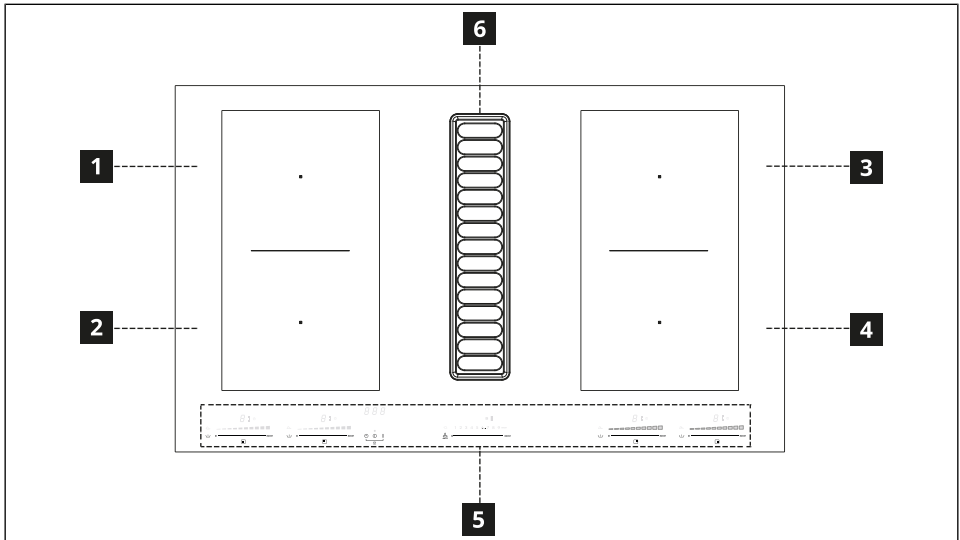

1	Single cooking zone (210x191 mm) 2100 W, with 3000 W Booster function
2	Single cooking zone (210x191 mm) 2100 W, with 3000 W Booster function
3	Single cooking zone (210x191 mm) 2100 W, with 3000 W Booster function
4	Single cooking zone (210x191 mm) 2100 W, with 3000 W Booster function
5	Control panel
6	Extractor
1 + 2	Combinable cooking zone (210x382 mm) 3000 W
3 + 4	Combinable cooking zone (210x382 mm) 3000 W

Indicators

Pan presence detection

Each cooking zone is equipped with a pan detection system. The pan detection system recognises pans with a magnetisable base suitable for use with induction hobs. If the pan is removed during cooking or if an unsuitable pan is used, the display next to the bar graph with flash with the symbol **U**. If there are no pans placed on the cooking

zone during the 10-second pan presence detection period:

- The cooking zone switches off automatically.
- The display of each cooking zone shows **U**.

Residual heat indicator

If a cooking zone has been switched off but it is still hot, the letter **H** will remain lit on the panel to indicate a burn hazard and fan is working.

Turning on the appliance

The cooking areas can be activated by pressing the desired zone.

When a pan is placed on one of the 4 cooking areas, the hob automatically detects its presence and lights up the corresponding digit to activate it.

If there are no pans or other objects on the hob, the digits are not visible.

The functions which can be selected are always visible on the control panel, but with a dimmed light. Select the functions by touching the corresponding symbol.

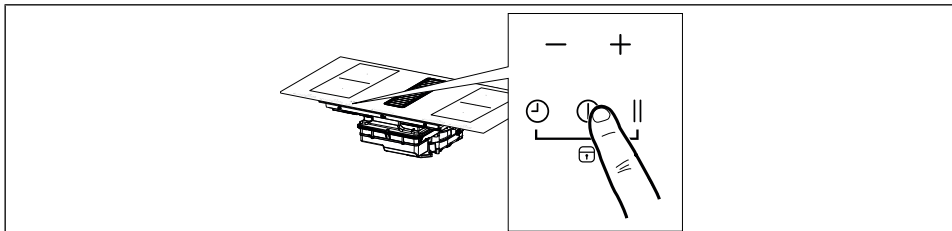

Press the On/Off button to turn the hob on and activate its functions.

At this point the hob is on but all the cooking zones and the hood are at zero power. The Hob will switch off automatically after 10 seconds if it is not being used.

Warning: For safety reasons, the hob can always be turned off using the On/Off button.

Warning: The functions that can be selected will always be the ones that are illuminated/visible on the control panel, and these will always be the only ones that can be activated.

The controls for the cooking areas, suction hood and timer can be activated by pressing on the reference Digit.

Warnings for the installer: Check the hob power setting and change it if necessary. See the **"Power limitation"** section.

By default, the hob is set for an absorption power of **7.4 Kw**.

Power limitation

When connecting to the household power supply for the first time, the installer must set the power of the cooking zones based on the actual capacity of the household power supply.

If this is not necessary, the hob can be turned on directly using ①, otherwise, follow the operations below to access the menu.

- Connect the hob to the domestic mains power (this operation must be performed each time the menu is accessed).
- All the digits light up for a few seconds.
- As soon as the digits go out again, press and hold ① and || for 4 seconds until the left swipe keyboards light up.
- Press and hold both swipe keyboards on the left for 4 seconds until the 3 control di-

gits indicate "CF6".

- Press || until "PHA" appears.
- Press the last keyboard on the left to select the correct setting.









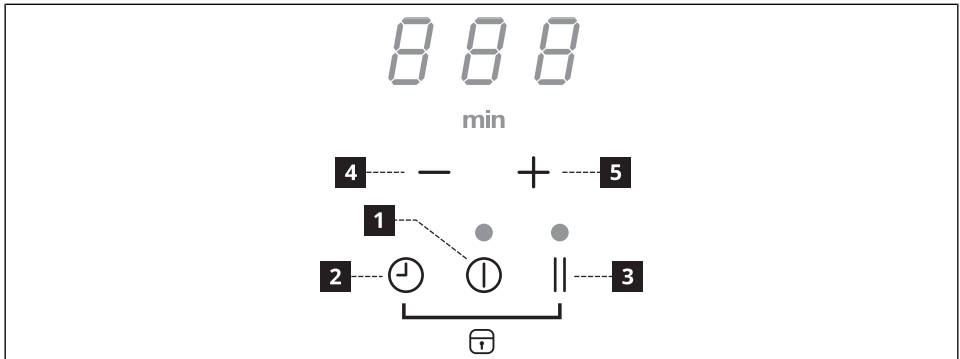





See the following table for the specifications:

Value on the power bar	KW	Notes
0	7.4	Standard initial setting
1	6	
2	5	
3	4	
4	3.5	
5	3	
6	2.5	

Once the correct value has been entered, confirm by pressing and holding ① and ||.





Control panel

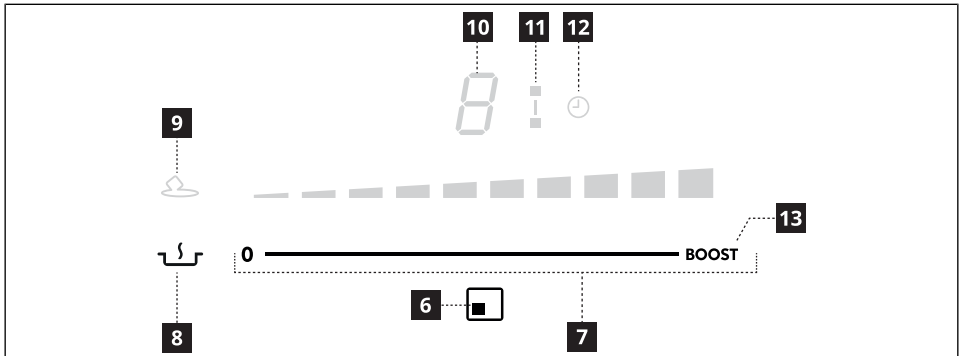

<p>1</p>	<p>On/Off</p>	<p>Switching the hob extractor on/off. Press to switch on. Press again to turn off.</p> <p>By default, when the hob extractor is turned on, the hood activates in automatic mode and the LED lights up . Tap (press) the selection bar to turn off the automatic mode and use the extractor fan in manual mode. The LED will  turn off.</p>
<p>2</p>	<p>Cooking zone timer</p>	<p>Select a cooking zone to set an independent timer. This key activates a timer that can be set for the individual cooking zones, even simultaneously. When the set time expires, the cooking zones will turn off automatically, and an audible signal will sound.</p> <p>Activating/adjusting the hob timer: Press the  key repeatedly to select the cooking zone to be activated. The icon corresponding to that cooking zone will light up. Having selected the desired cooking zone, set the duration of the timer: Press “+” to increase the time that will have to elapse before the automatic shutdown. Press “-” to decrease the time that will have to elapse before the automatic shutdown.</p>
<p>3</p>	<p>Stop&Go / Recall</p>	<p>This function is used to pause/recall any active function on the hob, by reducing the cooking power to zero. Press the key to activate the function, press it again and move the indicated slider completely from left to right (next to the pause function ) to deactivate it. Note: If the Pause function has not been deactivated after 10 minutes, the hob switches off automatically.</p> <p>This function is used to recover the settings of the hob in the event of accidental shutdown. Activation: - Turn the hob back on. - Press  within 6 seconds.</p>
<p>4  5</p>	<p>Increase/decrease</p>	<p>Increase/decrease the timer duration for the cooking zone.</p>
<p>4 + 5</p>	<p>Increase/decrease</p>	<p>Long press to reset the grease filter. Long press to reset the activated charcoal odour filter.</p>
<p>2 + 3</p>	<p>Lock Child lock</p>	<p>Locking/unlocking the cooking zone Simultaneously press keys  and  for a few seconds. “LOC” will appear on the display. It is used to lock the settings of the hob to avoid accidental tampering, leaving the functions already set active. Repeat the operation to deactivate the lock.</p> <p>Lock Simultaneously press keys  and , release and press  again. Hob appears on the display . Unlock Simultaneously press the keys  and , release and press  again. This allows you to lock the hob to prevent the accidental activation of the appliance.</p>

Cooking zone control panel



<p>6</p>	<p>Cooking zone position</p>	<p>Cooking zone position indicators.</p> <p>The cooking zones can be activated in combined mode to create a single zone with the same power level. The main cooking zones are the front ones while the secondary ones are the rear ones. To activate combined mode, touch the 2 bars at the same time: the symbol  will light up.</p> <p>With the main cooking zone selection bar, it is possible to select the desired power level. To deactivate combined mode, repeat the activation procedure.</p>
<p>7</p>	<p>Scroll keypad</p>	<p>Cooking zone selection. Increase/decrease in power level.</p> <p>Power Booster function, which remains active for 10 minutes, after which the temperature goes back to level 9. Touch and slide along the selection bar to activate the Power Booster function. The boost level will be shown on the display of the selected cooking zone with the symbol .</p>
	<p>Heating function</p>	<p>This function is used to heat a pan to the maximum power before continuing to cook at a selected level. The time interval for which the cooking zone is held at maximum power depends on the final cooking level that has been set. See the table:</p> <p>Power level "1" = 40 seconds Power level "2" = 72 seconds Power level "3" = 120 seconds Power level "4" = 176 seconds Power level "5" = 256 seconds Power level "6" = 432 seconds Power level "7" = 120 seconds Power level "8" = 192 seconds Power level "9" or "Booster" = Not available</p> <p>To enable, with a pan on the hob and the cooking zone selected, press and hold the selected value (from 1 to 8) on the power bar for 3 seconds. The display of the corresponding cooking zone indicates "A". It is possible to increase the cooking level, but decreasing it will deactivate the function.</p> <p>It can also be deactivated by touching and holding down the key of the cooking zone in question for 3 seconds.</p>
<p>8</p>	<p>Temperature management</p>	<p>Temperature management activation.  appears on the display.</p>
<p>9</p>	<p>Melting Function</p>	<p>Melting.</p>
<p>10</p>	<p>Cooking zone digit</p>	<p>It is activated if that specific cooking zone is being used.</p>
<p>11</p>	<p>Combo mode ("bridge" function)</p>	<p>Activation of the combination mode of two cooking zones.</p>
<p>12</p>	<p>Timer function</p>	<p>It is activated if the timer is set on that cooking zone.</p>
<p>13</p>	<p>Boost function</p>	<p>Activation of the Power Booster function.  appears on the display.</p>

Extractor control panel

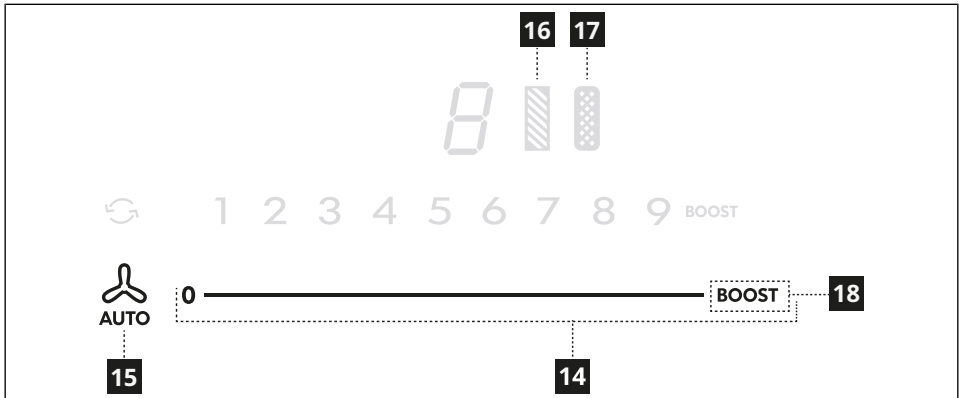

14	Scroll keypad	Suction power selection. Increase/decrease of suction speed (power).
15	Automatic extractor function	Activation/deactivation of an automatic function (by default, automatic mode is activated). Touching (pressing) the hood selection bar deactivates automatic mode and it is possible to use the extractor fan in manual mode. To reactivate automatic mode, press the key : the LED will light up to indicate that the extractor is active in that mode.
16	Charcoal filter maintenance symbol	If it is lit, it means that charcoal filter maintenance is required. By default, the charcoal filter maintenance reminder is deactivated (extraction mode). To activate the charcoal filter maintenance reminder, see the "User menu customisation" paragraph. Resetting and reactivating the charcoal odour filter: After carrying out maintenance on the filters, press the key "-" and hold it for 5 seconds. The odour filter LED will turn off and the countdown will restart.
17	Grease filter maintenance symbol	If lit, it means that grease filter maintenance is required. Resetting and reactivating the grease filter: After carrying out maintenance on the filters, press the key "-" and hold it for 5 seconds. The grease filter LED will turn off and the countdown will restart.
18	Boost function	BOOST speed setting: this speed is timed for a 5-minute activation. After this time, the system will automatically go back to the previously set speed.

Cookware guidance

Which pans to use

Only use pots and pans with the bottom made from ferromagnetic material which are suitable for use with inductions hobs:

- cast iron
- enamelled steel
- carbon steel
- stainless steel (including partial)
- aluminium with ferromagnetic coating or ferromagnetic plate

To determine if a pot or pan is suitable, check

for the  symbol (usually stamped on the bottom). You can also hold a magnet to the bottom. If it clings to the underside, the pan can be used on an induction hob.

To ensure optimum efficiency, always use pots and pans with a flat bottom that distributes the heat evenly. If the bottom is not perfectly flat, this will affect power and heat conduction.

How to use the pans

Minimum diameter of the pot/pan for the various cooking zones.

To ensure that the hob functions properly, the pan must cover one or more of the reference points indicated on the surface of the hob, and must be of a suitable minimum diameter.

Always use the hob that best corresponds to the diameter of the bottom of the pan.

Cooking areas	Pan base diameter	
	Ø min.(recommended)	Ø max (recommended)
Combined left Combined right	190 mm	230 mm
Single left Single right	110 mm	210 mm

Empty or thin-bottomed pots/pans

Do not use empty or thin-bottomed pots/pans on the hob as this would prevent controlling of the temperature or would

automatically switch off the cooking zone if the temperature is too high, with the risk of damaging the pan or the surface of the hob. If this occurs, do not touch anything and wait for all components to cool down.

If an error message appears, refer to "Troubleshooting".

Normal hob operating noises

Induction technology is based on the creation of electromagnetic fields. These electromagnetic fields generate heat directly on the bottom of the pan. Pots and pans may produce a variety of noises or vibrations, according to their construction.

These types of noise can be described as follows:

Slight hum (similar to the noise of a transformer)

This noise is produced when cooking with a high heat level and is caused by the quantity of energy being transferred from the hob to the pans. The noise will stop or decrease when the heat level is reduced.

Slight hissing

This noise is produced when the cooking container is empty and stops once the container is filled with water or food.

Crackling

This noise occurs with pans made from layers of numerous different materials, and is caused by vibration of the surfaces where the different materials meet. The noise comes from the pans, and may vary according to the quantity of food and preparation method being used.

Loud hissing

This noise occurs with pans made of different materials layered on top of each other and, furthermore, when these are being used at maximum speed and also on two cooking zones. The noise will stop or decrease when the heat level is reduced

Fan noises

For correct operation of the electronic system, it is necessary to adjust the temperature of the hob. To do this, the hob is equipped with a cooling fan that is activated to reduce and regulate the temperature in the electronic system. The fan may continue to operate after the appliance has been turned off, if the temperature of the cooker hob is still detected to be too high and display

H.



Rhythmic sounds similar to the ticking of a clock

This noise only occurs when at least three cooking zones are in operation and disappears or decreases when any of them are turned off.

The noises described are a normal feature of induction technology and are not to be considered as defects.

Daily use**Switching on the appliance**

Press and hold  for one second to switch the appliance on.

- The LED above the key  and the key  will light up.
- If no further selections are made, the appliance switches off after 10 seconds for safety reasons.

Cooking zone selection

If the product is used with only the extractor switched on at any level, after 1 minute, the zones will display „0“ on the slider (half brightness).

Press the „0“ next to the bar slider of the cooking zone and slide it with your finger to set the power level.

Switching off a cooking zone

Tap „0“ on the bar slider.

- If no further selections are made and the other cooking zones are switched off, the appliance switches off after 10 seconds.

Switching off the hob





Tap  and hold for a few seconds to switch off the hob.

- If no further selections are made on the display and all the cooking zones are switched off, the appliance switches off after 10 seconds.

Melting settings

With the melting function, it is possible to

defrost food or gently melt butter, chocolate or honey.

- Press  once.
-  and  will appear on the digit.
- To disable the melting function, change the power level or press .

Boost setting

All the cooking zones are equipped with the power boost function (Booster).

When the Booster function is activated, the selected cooking zone operates at an extra power for 5 minutes. The Booster function can be used, for example, to rapidly heat a large quantity of water.

- Slide a finger on the bar slider until  appears in the display.
- To deactivate the Booster function, return the bar slider to the desired power level with the swipe of your finger.

Timer

When the timer is set, the cooking zone turns off after a set time interval between 1 minute and 1 hour and 59 minutes.

Setting the timer

- The hob switches on.
- Cooking zone set.
- Press .
 - The indication „_00“ flashes in the centre of the display.

- Tap + to increase the duration of the time set on the timer, tap - to reduce it.

When pressing + for the first time, the indication "1" lights up on the display.

To deactivate the beep, press .

To set the Timer in another zone, repeat the procedure described above.



If the Timer is set for multiple zones, the Timer display will show the countdown closest to the end, while its icon will be full brightness. Instead, the icons of the other active Timers will be half brightness.

Modifying the timer

- Timer set
- Press the active cooking area for the timer to be modified.
- Press .
- Change the duration of the time set on the timer using + and -.



Combination function (bridge connection)

The combination function allows for two separate cooking zones to be activated so that they can be operated and controlled together.

- Press the bar sliders of the two cooking zones (on the same side) at the same time and select the slider where the digit shows ".
- The display next to the two zones displays  on one side and  on the other side.







If one of the cooking zones is already in operation when the combination function (bridge connection) is activated, the power level and operating time of this cooking zone will be selected for both the combined zones. If both zones are already in operation, the operating times are deleted in the power level displays. If two zones cannot be combined, set the Boost speed.

Locking/unlocking the cooking zone

Simultaneously press keys  and  for a few seconds. "LOC" will appear on the display.

It is used to lock the settings of the hob to avoid accidental tampering, leaving the functions already set active. Repeat the operation to deactivate the lock.

Child safety lock

- Appliance on
- To activate the child safety lock, simultaneously press  and , release and press  again until there is a beep. All the digits show ".
- The display is locked. When the display turns off in this state, the lock function will still be active when the hob is restarted.
- To deactivate the child safety lock, simultaneously press and hold for a few seconds  and , release and press  again.

The function remains active until it is disabled.

"Dry" function

Every time the hob is switched off, the extractor motor remains on for 5 minutes at the first speed level. During operation of the Dry function, all keys are disabled except for key  and key "0" of the extractor level.

- In order to deactivate the Dry function during operation, the user must switch the extractor level key from "1" to "0".

Stop&Go / Recall

This function is used to pause/recall any active function on the hob, by reducing the cooking power to zero.

Press the key to activate the function, press it again and move the indicated slider completely from left to right (next to the pause function ) to deactivate it.

Note: If the Pause function has not been deactivated after 10 minutes, the hob switches off automatically.

This function is used to recover the settings of the hob in the event of accidental shutdown.

Activation:

- Turn the hob back on.
- Press **II** within 6 seconds.

Lock

Locking/unlocking the cooking zone
 Simultaneously press keys **II** and  for a few seconds. "LOC" will appear on the display. It is used to lock the settings of the hob to avoid accidental tampering, leaving the functions already set active. Repeat the operation to deactivate the lock.

Heating function

This function is used to heat a pan to the maximum power before continuing to cook at

a selected level.
 The time interval for which the cooking zone is held at maximum power depends on the final cooking level that has been set.
 See the table in the "Cooking zone control panel" chapter.
 To enable, with a pan on the bob and the cooking area selected, press and hold the selected value (from 1 to 8) on the power bar for 3 seconds. The display of the corresponding cooking zone indicates "A". It is possible to increase the cooking level, but decreasing it will deactivate the function. It can also be deactivated by touching and holding down the key of the cooking zone in question for 3 seconds.

Power level	Cooking method	To be used for
1	Melting, heating gently	Butter, chocolate, gelatine, sauces
2	Melting, heating gently	Butter, chocolate, gelatine, sauces
3	Warming up	Rice
4	Prolonged cooking, thickening, stewing	Vegetables, potatoes, sauces, fruit, fish
5	Prolonged cooking, thickening, stewing	Vegetables, potatoes, sauces, fruit, fish
6	Prolonged cooking, braising	Pasta, soup, braised meat
7	Light frying	Rösti (potato fry-ups), omelettes, breaded and fried foods, sausages
8	Frying, deep fat frying	Meat, potato chips
9	Frying, deep fat frying	Steaks
P	Quick heating	Boiling water

Temperature level	Cooking method	To be used for
	Melt	Melt butter, chocolate or honey at approximately 42°C.

User menu customisation

The user can perform some adjustment operations on the product. Follow the procedure below to enter the menu.

Switch the appliance on and off within 3 seconds.

Press and hold keys "+" and "-" for 3 seconds until the menu acronyms (U1, U2, U3...) are

shown in the Timer Digits.

Use keys "+" and "-" to scroll through the menu.

The keypads on the left will light up, displaying the values that can be selected.

See the following table for the menu specifications:

Menu code	Description	Value
U1	Key sound volume control menu.	0 - Sound off 1 - Min. 2 - Medium 3 - Max
U2	Tone and beep volume management menu.	0 - Sound off 1 - Min. 2 - Medium 3 - Max
U3	Countdown management menu.	0 - Sound off 1 - Short beep 2 - Long beep
U4	"Dry" function.	0 - Not active 1 - Active
U5	Charcoal filter activation	0 - Not active 1 - Active

Press and hold keys "+" and "-" for 3 seconds to save the settings and exit the menu.

Power management

This product has an electronically controlled power management function.

This function controls the delivery of the maximum power of 3000 W between the combined cooking areas (left and right side), optimising the power distribution and avoiding system overload situations.

The function distributes the maximum power available between the cooking areas used in combi mode. See the illustration. The function reduces the power of the other cooking area working in combi mode, if necessary (the highest priority is assigned to the last command).

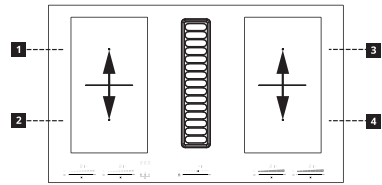

Example:

If the additional power level (boost) (P) is selected for cooking zone 1, cooking zone 2 cannot simultaneously exceed power level 5.

Troubleshooting

Error code	Description	Possible causes of the error	Solution
	Operation absent	Incorrect connection to the mains or short circuit	Disconnect the hob extractor from the power supply. Correctly connect to the power supply by referring to the paragraph "ELECTRICAL CONNECTION" if necessary. If the error persists, please contact the After-Sales Service and specify the problem.
ER 03 and continuous sound or P	The control panel switches off after 10 s.	Continuous activation of the sensors. Water or pan on the glass over the control panel.	Remove water or pan from the ceramic glass surface and from the control panel. Turn off the hob extractor.
ER 03 and continuous sound of the Extractor control panel	The control panel switches off after 10 s. The extractor motor is still running.	Continuous activation of the sensors detected. Water or pan on the glass over the extractor control panel.	Remove water or pan from the ceramic glass surface and from the control panel. Tap the extractor panel again.
ER47	ER and 47 flash. The control panel switches off after 10 s.	Product side power cable connection error.	Disconnect the extractor from the electrical power supply. Adjust the connection following the instructions in the ELECTRICAL CONNECTION paragraph if necessary with particular attention to the correct fastening of the bridges on the product side. If the error persists, please contact the After-Sales Service and specify the problem.
E/6	ER and 47 flash. The control panel switches off after 10 s.	Deviations of mains power supply in frequency or voltage level. Solar-powered inverters could cause an E6 error if an oscillation on the mains voltage is created (high-frequency overvoltage).	As soon as the mains power supply returns to normal, the E6 error disappears. If the error persists, please contact the After-Sales Service and specify the problem.
ER20 - ER22 - ER30 - ER36 - ER39 - U400 - E/2 - E/A - E/4 - E/7 - E/8 - E/9	Disconnect the hob extractor from the power supply. Wait a few seconds, then reconnect the hob extractor to the power supply. If the problem persists, contact the After-Sales Service and specify the error code that appears on the display.		

i If there is a fault try to solve the problem by following the troubleshooting guidelines. If the

problem cannot be solved contact the After-Sales Service. You can find a full list of IKEA appointed contacts at the end of this user manual.

i If you operate the appliance incorrectly, or the installation was not carried out by an authorised installer, the visit from the After-Sales Service technician or dealer will not be free of charge, even during the warranty period.

Maintenance and repair

- Make sure that maintenance on electrical components is only carried out by the manufacturer or by the service technicians.
- Make sure that damaged cables are only replaced by the manufacturer or by the service technicians.

When contacting the service department, please provide the following information:

- Type of fault
- Device model (Art./Cod.)
- Serial number (S.N.)

This information can be found on the identification plate. The identification plate is affixed to the bottom of the device.

Technical data

Product identification

Type: **4300**

Model: **TÄCKNAN**

Please see the identification plate affixed to the bottom of the product.

The manufacturer makes continual improvements to products. For this reason, the text and illustrations in these instructions for use may change without warning.

Further information on the technical data is available on the website: www.ikea.com

Extractor technical data

Type of product			BUILT-IN
	Width	mm	830
Dimensions	Depth	mm	520
	Min/max height	mm	496
Max air flow* - Exhaust Installation		m3/h	600
Max noise level* - Exhaust Installation		dBA	68
Max air flow* - Recirculation Installation**		m3/h	420
Max noise level* - Recirculation Installation**		dBA	71
Extractor rated power		W	250
Hob rated power		W	7400
Total maximum power		W	7650

* Maximum speed (excluding Boost).

** Recirculation Installation - The airflow value for complete recirculation installation with 806-231-27 NYTTIG recirculation kit for hob.

Power supply voltage/frequency	220-240 V, 50 Hz; 220 V, 60 Hz 2N~ 380-415 V, 50 Hz; 2N~ 380 V, 60 Hz
Weight of appliance	23.6 Kg

This appliance has been designed, manufactured and sold in compliance with EEC Directives.

The technical data are indicated on the rating plate affixed inside the appliance.



Extractor energy efficiency

Product information	Unit	Value
Model id		TÄCKNAN 006.143.39
Annual energy consumption	kWh/a	30.7
Time increase factor		0.8
Fluid dynamics efficiency		33.8
Energy efficiency index		42
Air flow measured at the optimum efficiency point	m ³ /h	290
Air pressure measured at the optimum efficiency point	Pa	440
Electrical power supply measured at the optimum efficiency point	W	105
Current consumption measured in standby	W	0
Current consumption measured when off	W	0.49
Energy Efficiency Class		A+
Fluid Dynamic Efficiency Class		A
Grease Filtering Efficiency	%	8.1
Grease Filtering Efficiency Class		B
Air flow at minimum speed	m ³ /h	200
Air flow at maximum speed	m ³ /h	600
Air flow at booster speed	m ³ /h	650
Air-weighted sound power emission at minimum speed	dB(A)	43
Air-weighted sound power emission at maximum speed	dB(A)	68
Air-weighted sound power emission at booster speed	dB(A)	71

Energy saving

The appliance includes features which help to save energy during cooking every day.

Environmental aspects

Information on disposal

Your obligations as an end-user



This electrical or electronic equipment is marked with a crossed-out wheeled bin. The equipment may therefore only be collected and returned separately from unsorted municipal waste, i.e. it must not be disposed of with household waste. The equipment can be returned, for example, to a municipal collection point or, if applicable, to a distributor (see below for their take-back obligations in Germany). This also applies to all components, subassemblies and consumables of the old equipment to be disposed of.

Before the old equipment may be disposed of all old batteries and old accumulators that are not enclosed by the old equipment must be separated from the old equipment. The same applies to lamps that can be removed from the old equipment without destroying them. The end-user is also responsible for deleting personal data from the old equipment.

Notes on recycling

Disposal of packaging materials



Help recycle all materials marked with this symbol. Do not dispose of such materials, especially packaging, in the household waste but via the relevant containers provided or the appropriate local collection systems.

Help to protect the environment and human health by recycling including waste of electrical and electronic appliances.

The following additional information applies in Germany

Take-back obligations of distributors

Anyone who sells electrical and electronic equipment on a sales floor area of at least

400 m² or otherwise supplies it to end users on a commercial basis is obliged, when supplying a new equipment, to take back at the place of supply or in the immediate vicinity thereof free of charge an old equipment belonging to the end user of the same type of equipment which fulfils essentially the same functions as the new equipment. This also applies to distributors of groceries with a total sales area of at least 800 m² who offer electrical and electronic equipment several times a calendar year or on a permanent basis and make it available on the market. In addition, such distributors must, at the request of the end-user, take back in the retail shop or in the immediate vicinity free of charge old equipment that does not exceed 25 cm in any external dimension (small electrical equipment) thereof; in this case, take-back may not be linked to the purchase of an electrical or electronic equipment but may be limited to three old equipment per type of equipment.

The place of delivery is also the private household if the new electrical or electronic equipment is de-livered; in this case the collection of the old equipment is free of charge for the end user.

The above obligations also apply to distribution using means of distance communication if the distributors maintain storage and dispatch areas for electrical and electronic equipment or total storage and dispatch areas for groceries that correspond to the sales areas mentioned above. However, the free collection of electrical and electronic equipment is then restricted to heat transmitters (e.g. refrigerators), screens, monitors and equipment containing screens with a surface area of more than 100 cm² and equipment where at least one of the external dimensions is more than 50 cm. For all other electrical and electronic equipment the distributor must ensure appropriate return

facilities within a reasonable distance from the respective end-user; this also applies to small electrical equipment (see above) that the end-user wishes to return without purchasing a new equipment.

Energy saving

You can save energy during everyday cooking if you follow hints outlined below.

- When you heat water, only use the quantity you require.
- If it is possible, always put the lids on the cookware.
- Place the pan on the hob before you switch it on.
- Put smaller pans on the smaller cooking areas.
- Put the pans directly in the centre of the cooking area.
- Use residual heat to keep the food warm or melt it.

IKEA guarantee

Do you need extra help?

For any additional questions not related to After Sales of your appliances, like clarifications on installation of the IKEA appliance in the dedicated IKEA kitchen furniture or for clarification on functions of the IKEA appliances, please contact your nearest IKEA Customer Support Centre, the number is available on www.IKEA.com. We recommend you read the appliance documentation carefully before contacting us.

Read about our guarantee terms on www.ikea.com.

For requests under this guarantee, do not hesitate to contact the IKEA appointed Authorized Service Centre. See the relative national phone numbers on the next page.

For quicker service, always refer to the IKEA article number (8-digit code) and the 12-digit service number found on the rating plate of your appliance.

SAVE THE SALES RECEIPT.

Country name in local languages	Telephone number	Opening times
Österreich	13602771461	Mo-Fr: 8 - 20
België / Belgique	26200311	Ma-Vr: 8 - 20 / Lun-Ven: 8 - 20
България	02 4003536	Пон-Пт: 8 - 20
Canarias	913754126	Lunes-Viernes: 8 - 20
Κύπρος	http://www.ikea.com	8 - 20
Hrvatska	0800 3636	Pon-Pet: 8 - 20
Česká republika	225376400	Po-Pá: 8 - 20
Danmark	70150909	Man.-Fre.: 9 - 20
Eesti	http://www.ikea.com	E-R: 8 - 20
Suomi	981710374	Lu-Ve: 8 - 20
France	170480513	Lun-Ven: 9 - 21
Deutschland	6929993602	Mo-Fr: 8 - 20
Great Britain	2076601517	Mon-Fri: 8 - 20
Ελλάδα	2109696497	Δευ-Παρ: 8 - 20
Magyarország	(06-1)-3285308	Hétfő-Péntek: 8 - 20
Italia	+39 02/38591334	Lun-Ven: 8 - 20
Ireland	2076601517	Mon-Fri: 8 - 20
Ísland	5852409	Mánudagur-Föstudagur Kl.: 8 - 20
Latvija	http://www.ikea.com	P.- Pk.: 8 - 20
Lietuva	(0) 520 511 35	Pirm.-Penkt.: 8 - 20
Mayorca	913754126	Lunes-Viernes: 8 - 20
Malta	+356 (0)25464000	Mon-Fri: 8 - 20
Norge	23500112	Man-Fre: 8 - 20
Nederland	050-7111267 / +31 507111267	Ma-Vr: 8 - 20
Polska	225844203	Poniedziałek-Piątek: 8 - 20
Portugal	213164011	Seg.-Sex.: 9 - 21
România	021 2044888	Luni-Vineri: 8 - 20
Россия	84957059426	Пон-Пятн: 9 - 21
Србија	011 7 555 444	Пон-Пет: 8 - 20
Slovensko	(02) 50102658	Pon-Pia: 8 - 20
Slovenija	+386-1-8107781	Ponedeljek-Petek: 8 - 20
España	913754126	Lunes-Viernes: 8 - 20
Sverige	0775-700 500	Mån-Fre: 8 - 20
Schweiz / Suisse / Svizzera (Ticino)	225675345	8 bis 20 Werktage / Lun-Ven: 8 - 20
Türkiye	+90/262/644 65 95	Pzt-Cuma: 8 - 20
Україна	http://www.ikea.com	Понеділок-П'ятниця: 8 - 20
Марок / المغرب	+212 (5) 20100900 www.ikea.com	

991.0758.310.02
D00000010864.01
260310

