

OMNEJD

en



Design and Quality
IKEA of Sweden



1x



39x



4x

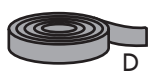

2x



2x

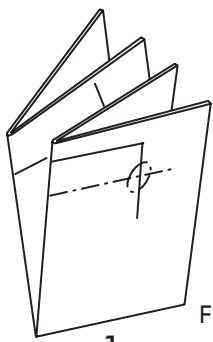

1x

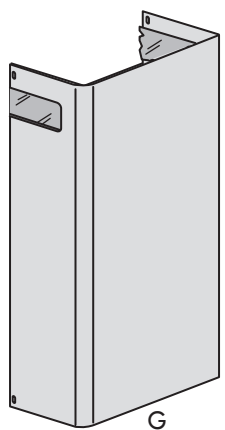

2x

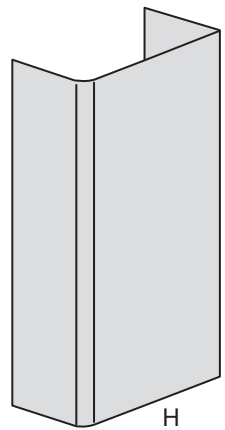

2x

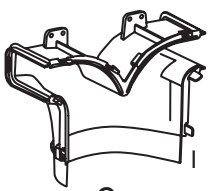

2x

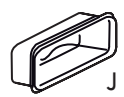

2x



1x

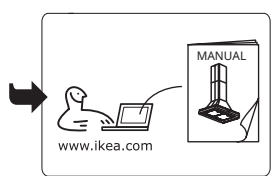
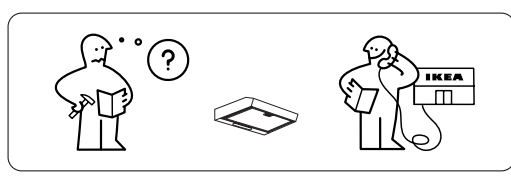
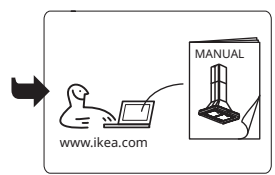
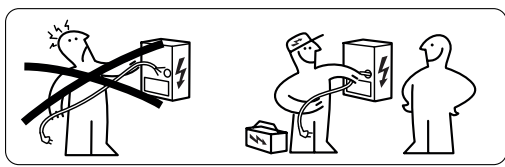

Description of the appliance

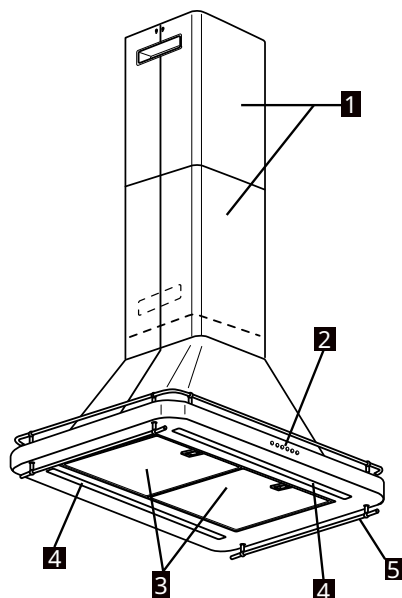

- 1** Telescopic chimney.
- 2** Control panel.
- 3** Grease filter.
- 4** Lamp.
- 4** Lamp.
- 5** Ladle holder.

Control Panel

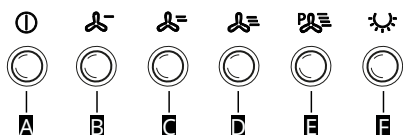

- A** Motor OFF button
- B** Suction power 1 selection button
- C** Suction power 2 selection button
- D** Suction power 3 selection button

E Suction power 4 selection button -
Duration 5 minutes

F ON/OFF light button

NB: with the light on, press and hold to adjust its intensity

NB: Please note that there will be a 5-second delay when switching directly to suction power 1 (from any other speed) due to the electronic control of the product.

Technical Data

Type of appliance	Ceiling-mounted extractor hood		
Dimensions	Width	mm	898
	Depth	mm	599
	Total height in suction mode (min-max)	mm	968-1315
	Total height in recirculation mode (min-max)	mm	968-1315
Total power		W	177
Light info	Type		LED
	Number & Power	W	2x3.5W
	Connection		LED Strip
Minimum installation height - gas cooker		mm	650
Minimum installation height - electric cooker		mm	500
Product weight		Kg	25.2
Product information in accordance with EU Regulation no. 65/2014 - UK SI 2019 No.539			
Name of Supplier			IKEA
Model identification code			OMNEJD 30517879
Annual energy consumption - AEC		Kwh/year	25.6
Energy efficiency class			A++
Fluid dynamic efficiency FDE		%	38.5
Fluid dynamic efficiency class			To
Luminous efficiency LE		lux/W	44.1
Luminous efficiency class		lux	To
Grease filtering efficiency - GFE		%	75.1
Grease filtering efficiency class			C
Minimum air flow (normal power)		m3/h	200.0
Maximum air flow (normal power)		m3/h	415.0
Airflow setting in boost mode		m3/h	770.0
A-weighted sound power level of noise emissions at minimum speed		Db(A) re 1pW	42.0
A-weighted sound power level of noise emissions at maximum speed		Db(A) re 1pW	57.0
A-weighted sound power level of noise emissions in boost mode		Db(A) re 1pW	72.0
Power consumption in off mode-P0		W	NA
Power consumption in standby mode-Ps		W	0.49
Product information in accordance with EU Regulation no. 66/2014 - UK SI 2019 No.539			
Factor of increase over time - f			0.6
Energy efficiency index - EEI			36.3
Airflow measured at best efficiency point - QBEP		m3/h	365.0
Air pressure measured at best efficiency point - PBEP		Pa	355.0
Maximum airflow - Qmax		m3/h	770.0
Electric power consumption at best efficiency point - WBEP		W	93.5
Rated power of lighting system - WL		W	7.0
Average illuminance of the lighting system on the cooking surface - Emiddle		Lux	309.0



© Inter IKEA Systems B.V.
02/2026

23244

AA-2410288-2

LIB0190847A Ed. 03/26