

LAGAN



Contents

Safety information	3	Daily use	11
Safety instructions	4	Hints and tips	14
Product description	6	Care and cleaning	16
Control panel	7	Troubleshooting	17
Programmes	8	Technical information (EN60436)	21
Functions	9	Environmental concerns	22
Settings	9	IKEA guarantee	22
Before first use	10		

Subject to change without notice.

⚠ Safety information

Before the installation and use of the appliance, carefully read the supplied instructions. The manufacturer is not responsible for any injuries or damages that are the result of incorrect installation or usage. Always keep the instructions in a safe and accessible location for future reference.

Children and vulnerable people safety

- This appliance can be used by children aged from 8 years and above and persons with reduced physical, sensory or mental capabilities or lack of experience and knowledge if they have been given supervision or instruction concerning the use of the appliance in a safe way and understand the hazards involved.
- Children between 3 and 8 years of age and persons with very extensive and complex disabilities shall be kept away unless continuously supervised.
- Children of less than 3 years of age should be kept away unless continuously supervised.
- Do not let children play with the appliance.
- Keep detergents away from children.
- Keep children and pets away from the appliance when the door is open.
- Children shall not carry out cleaning and user maintenance of the appliance without supervision.
- Keep all packaging away from children and dispose of it appropriately.

General Safety

- This appliance is intended to be used in household and similar applications such as:
 - Farm houses; staff kitchen areas in shops, offices and other working environments;
 - By clients in hotels, motels, bed and breakfast and other residential type environments.
- Do not change the specification of this appliance.
- The operating water pressure (minimum and maximum) must be between 0.4 (0.04)/10 (1.0) bar (MPa).
- Obey the maximum number of 13 place settings.
- When positioning the appliance, ensure the supply cord is not trapped or damaged.
- If the supply cord is damaged, it must be replaced by the manufacturer, its Authorised Service Centre or similarly qualified persons in order to avoid a hazard.
- Keep ventilation openings, in the appliance enclosure or in the built-in structure, clear of obstruction.
- Put the cutlery in the cutlery basket with the sharp ends pointing down or put them in the cutlery rack in a horizontal position with the sharp edges down.

- Do not leave the appliance with the open door unattended to avoid stepping accidentally onto it.
- Before any maintenance operation, deactivate the appliance and disconnect the mains plug from the socket.
- Do not use high pressure water sprays and/or steam to clean the appliance.
- If the appliance has ventilation openings in the base, they must not be covered e.g. by a carpet.
- The appliance is to be connected to the water mains using the new supplied hose-sets. Old hose sets must not be reused.

Safety instructions

Installation

- ⚠ **WARNING!** Only a qualified person can install this appliance.
- Remove all the packaging and the transit bolts.
- Do not install or use a damaged appliance.
- Do not install or use the appliance where the temperature is less than 0 °C.
- Follow the installation instruction supplied with the appliance.
- Always take care when moving the appliance as it is heavy. Always use safety gloves and enclosed footwear.
- Make sure that the appliance is installed below and adjacent to safe structures.

Electrical connection

- ⚠ **WARNING!** Risk of fire and electrical shock.
- ⚠ **WARNING!** When positioning the appliance, ensure the supply cord is not trapped or damaged.
- ⚠ **WARNING!** Do not use multi-plug adapters and extension cables.
- ⚠ **WARNING!** Do not, under any circumstances, cut, remove, or bypass the grounding prong
- The appliance must be earthed.
- Make sure that the parameters on the rating plate are compatible with the electrical ratings of the mains power supply.

- Always use a correctly installed shockproof socket.
- Make sure not to cause damage to the electrical components (e.g. mains plug, mains cable). Contact the Authorised Service Centre to change the electrical components.
- Connect the mains plug to the mains socket only at the end of the installation. Make sure that there is access to the mains plug after the installation.
- Do not pull the mains cable to disconnect the appliance. Always pull the mains plug.
- This appliance complies with the E.E.C. Directives.
- UK and Ireland only: This appliance is fitted with a 13 A mains plug. If it is necessary to change the mains plug fuse, use only a 13 A ASTA (BS 1362) fuse.

Water connection

- Do not cause damage to the water hoses.
- Before connection to new pipes, pipes not used for a long time, where repair work has been carried out or new devices fitted (water meters, etc.), let the water flow until it is clean and clear.
- Ensure that there are no visible water leaks during and after the first use of the appliance.
- The water inlet hose has a safety valve and a sheath with an inner mains cable.

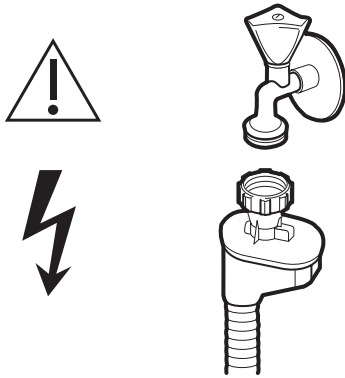

⚠ WARNING! Dangerous voltage.

- If the water inlet hose is damaged, immediately close the water tap and disconnect the mains plug from the mains socket. Contact the Authorised Service Centre to replace the water inlet hose.

Use

⚠ WARNING! Risk of injury, burns, electrical shock or fire.

⚠ WARNING! Do not use the appliance before installing it in the built-in structure. The appliance must be disconnected from the power supply before any installation work is done – risk of electric shock.

- Do not sit or stand on the open door.
- Dishwasher detergents are dangerous. Obey the safety instructions on the detergent packaging.
- Use only detergent and rinse aid recommended for use in an automatic dishwasher.
- Never use soap, laundry detergent, or hand washing detergent in your dishwasher.
- Do not drink and play with the water in the appliance.
- Dishwasher detergent is corrosive! Keep dishwasher detergent out of the reach of children.
- Do not remove the dishes from the appliance until the programme is complete. Some detergent may remain on the dishes.

- The appliance can release hot steam if you open the door while a programme operates.
- Do not put flammable products or items that are wet with flammable products in, near or on the appliance.

Service

- To repair the appliance contact an Authorised Service Centre.
- Use original spare parts only.

Disposal

⚠ WARNING! Risk of injury or suffocation.

- Disconnect the appliance from the mains supply.
- Cut off the mains cable and discard it.
- Remove the door to prevent children and pets to be closed inside of the appliance.

Note:

When connecting to drinking water make sure that you connect the appliance using a safety device against drinking water contamination through backflow (according to DIN EN 1717) and meet water pollution requirements (according to KTW- BWGL). Product shall be constructed to prevent backsiphonage of non-potable water into the water mains according to IEC/EN 61770. We recommend that installation, including water supply and electrical connections, and repairs are carried out by a qualified technician.

Product description

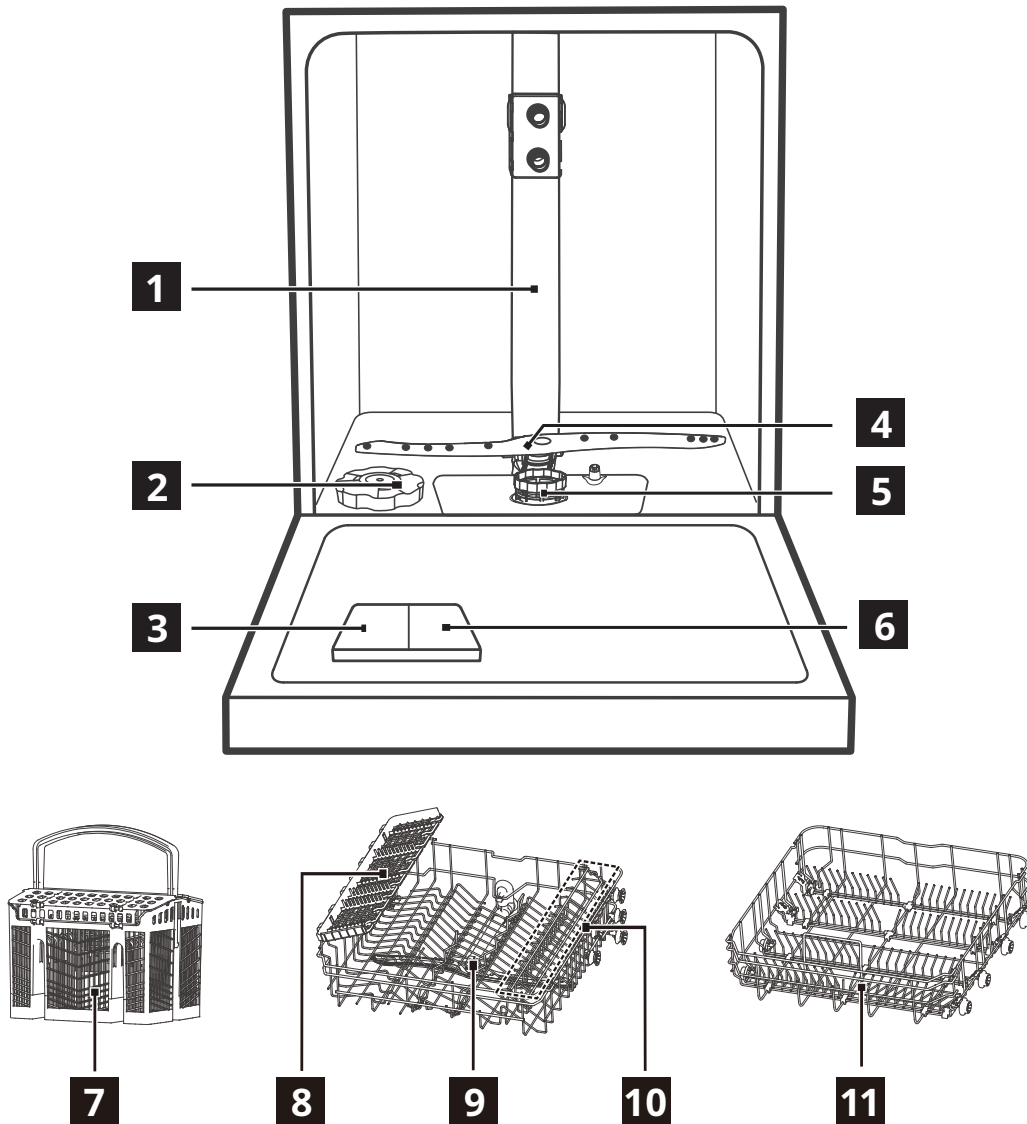

- | | |
|------------------------------|--------------------------------------|
| 1 Inner pipe | 7 Cutlery basket |
| 2 Salt container | 8 Cutlery rack (Upper basket) |
| 3 Detergent dispenser | 9 Upper spray arm |
| 4 Lower spray arm | 10 Cup rack (Upper basket) |
| 5 Filter assembly | 11 Lower basket |
| 6 Rinse aid dispenser | |



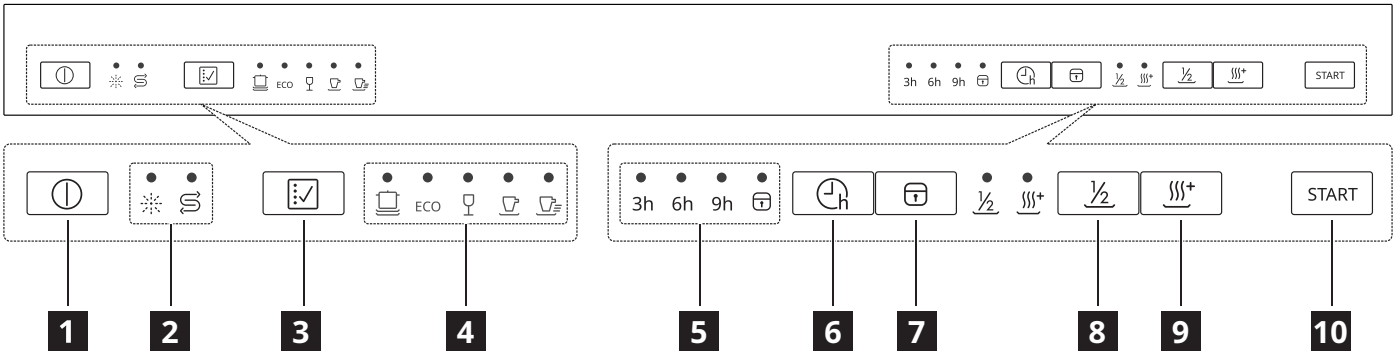

Control panel



- 1** On/Off button
- 2** Warning indicators
- 3** Programme button
- 4** Programme indicators
- 5** Delay time
- 6** Delay button
- 7** Child lock button
- 8** Half-load button
- 9** Extra Drying button
- 10** Start/Pause button













Indicators	Description
	Rinse aid indicator. It is always on when the rinse aid dispenser needs refilling.
	Salt indicator. It is always on when the salt container needs refilling.
	Delay start indicator. It is on when a delay start setting is present.
	Child lock indicator. It is on when the Child lock function is activated.
	Half-load indicator. It is on when the Half-load function is selected.
	Extra Drying indicator. It is on when the Extra Drying function is selected.

Programmes

Programme	Degree of soil/ Type of load	Programme phases	Options
 (Intensive)	<ul style="list-style-type: none"> • Heavy soil • Crockery, cutlery, pots and pans 	<ul style="list-style-type: none"> • Prewash • Wash (60 °C) • Rinse • Rinse (65-72 °C) • Drying 	<ul style="list-style-type: none"> • Delay start • Half-load • Extra Drying
ECO (ECO) ¹⁾	<ul style="list-style-type: none"> • Normal soil • Crockery and cutlery and pans 	<ul style="list-style-type: none"> • Prewash • Wash (45 °C) • Rinse (60 °C) • Drying 	<ul style="list-style-type: none"> • Delay start • Half-load • Extra Drying
 (Glass)	<ul style="list-style-type: none"> • Light soil • Glass 	<ul style="list-style-type: none"> • Prewash • Wash (45 °C) • Rinse • Rinse (55-60 °C) • Drying 	<ul style="list-style-type: none"> • Delay start • Half-load • Extra Drying
 (90 min)	<ul style="list-style-type: none"> • Normal soil 	<ul style="list-style-type: none"> • Wash (55 °C) • Rinse • Rinse (60-65 °C) • Drying 	<ul style="list-style-type: none"> • Delay start • Half-load • Extra Drying
 (Rapid)	<ul style="list-style-type: none"> • Light soil • Crockery and cutlery 	<ul style="list-style-type: none"> • Wash (45 °C) • Rinse • Rinse (45 °C) 	<ul style="list-style-type: none"> • Delay start

1) With this programme you have the most efficient use of water and energy consumption for crockery and cutlery with normal soil. (This is the standard programme for test institutes).

Consumption values

Programme	Drying phase	Available functions	Programme duration (min)	Water consumption (litres/cycle)	Energy consumption (kWh/cycle)
	✓	 ½  ⁺	180	13.9	1.275-1.385
ECO	✓	 ½  ⁺	230	11.0	0.937
	✓	 ½  ⁺	125	13.9	0.850-0.925
	✓	 ½  ⁺	90	11.2	0.955-1.030
	-		30	10.3	0.584

1. The pressure and the temperature of the water, the variations of the mains supply, the options and the quantity of dishes can change the values.
2. ECO programme is suitable to clean normally soiled tableware, and it is the most efficient programme in terms of its combined energy and water consumption. This programme is also used to assess compliance with the EU eco-design legislation.
3. Washing tableware in a household dishwasher usually consumes less energy and water in the use phase than hand dishwashing when the household dishwasher is used according to the manufacturer's instructions.
4. The values given for programmes other than the eco programme are indicative only.



Information for test institutes

To receive the necessary information for conducting performance tests (e.g. according to EN60436), send an email to:

info.dishwasher@meicloud.com

In your request, please include the product number code (PNC) found on the rating plate.

Functions

-  It is not possible to activate or deactivate options while a programme is running.
-  If a function is not applicable to a programme, the related indicator is off.
-  Activating functions can affect the water and energy consumption as well as the programme duration.

Child lock

This option allows you to lock the buttons on

the control panel, except for the On/Off button, so children cannot accidentally start the dishwasher by pressing the buttons on the panel.

To lock or unlock the buttons on the control panel, press the Child lock button  for 3 seconds.

Half-load function

For smaller loads, you can choose this function to save energy and water.

To select the Half load function, press the Half-load button  after selecting a programme.

Settings

The water softener

The water softener removes minerals from the water supply, which would have a detrimental effect on the washing results and on the appliance.

The higher the content of these minerals, the harder your water is. Water hardness is measured in

equivalent scales.

The water softener should be adjusted according to the hardness of the water in your area. Your local water authority can advise you on the hardness of the water in your area. It is important to set the right level of the water softener to assure good washing results.

Water hardness

German degrees (°dH)	French degrees (°fH)	mmol/l	Clarke degrees	Water softener level	Salt consumption (gram/cycle)	Regeneration frequency (Every X cycles)
35 - 55	61 - 98	6.1 - 9.8	43 - 69	H6	60	1
23 - 34	41 - 60	4.1 - 6.0	29 - 42	H5	30	2
18 - 22	31 - 40	3.1 - 4.0	22 - 28	H4	20	3
12 - 17	21 - 30	2.1 - 3.0	15 - 21	H3 ¹⁾	12	5
6 - 11	10 - 20	1.0 - 2.0	7 - 14	H2	9	10
0 - 5	0 - 9	0 - 0.94	0 - 6	H1 ²⁾	0	NO

1) Factory setting.

2) Do not use salt at this level.



Whether you use a standard detergent or multi-tablets (with or without salt), set the proper water hardness level to keep the salt refill notification active.

-  Multi-tablets containing salt are not effective enough to soften hard water.

During every regeneration, an additional 2.0 liters of water is required, energy consumption increases by 0.02kWh and the programme is extended by 4 minutes.

How to set the water softener level

1. Close the dishwasher door and press the On/Off button to switch the appliance on.
2. Within 60 seconds after switching on, press the Programme button for more than 5 seconds to enter the water softener setting mode. The salt indicator will flash.
3. Press the Programme button to select the correct setting according to your local water hardness, the setting will change in the following order: H3->H4->H5->H6->H1->H2->H3.
4. Wait 5 seconds or press the On/Off button to confirm the setting and exit.

Water softener level	LED indicator (○ : indicator off; ● : indicator on)		
			
H1	○	○	●
H2	○	●	○
H3	○	●	●
H4	●	○	○
H5	●	○	●
H6	●	●	○

The rinse aid empty notification

The rinse aid helps to dry the dishes without streaks and stains. For best drying performance, always use rinse aid.

The rinse aid is automatically released during the hot rinse phase.

When rinse aid dispenser is empty, the rinse aid indicator () lights up reminding you to refill rinse aid. At other times, you can estimate the remaining amount by the size of the black dot on the rinse aid level indicator, as illustrated below:

- Full
- 3/4 full
- 1/2 full
- 1/4 full
- Empty

The rinse aid level

It is possible to set the released quantity of rinse aid between level 1 (minimum quantity) and level 4 (maximum quantity).

How to set the rinse aid level

Remove the rinse aid reservoir cap. Turn the rinse aid indicator dial to a number (1-4).

If the dishes are not drying properly or are spotted, adjust the dial to the next higher number until your dishes are spot-free. Reduce it if there are sticky whitish stains on your dishes or a bluish film on glassware or knife blades.

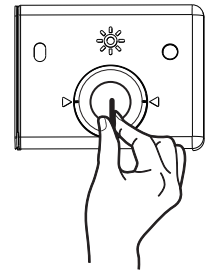

Activating/deactivating the key sound

Press and hold the $\frac{1}{2}$ and ||||^+ buttons for 3 seconds to activate or deactivate the key sound.

Before first use

1. **Make sure that the current level of the water softener agrees with the hardness of the water supply. If not, adjust the level of the water softener.**
2. Fill the salt container.
3. Fill the rinse aid dispenser.
4. Open the water tap.
5. Start a programme to remove any processing residuals that can still be inside the appliance. Do not use detergent and do not load the baskets.

i After starting a programme, it may take up to 5 minutes for the appliance to recharge the resin in the water softener. It seems that the appliance is not working. The washing phase starts only after this procedure is completed. The procedure is repeated periodically.

The salt container

⚠ CAUTION! Use rough salt designed for dishwashers only. Fine salt increases the risk of corrosion.

The salt is used to recharge the resin in the water softener and to assure good washing results in daily use.

Filling the salt container

- i** Fill the salt only when the salt indicator turns on.

1

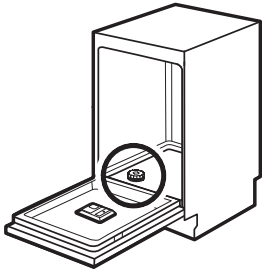

Find the salt container at the bottom.

2

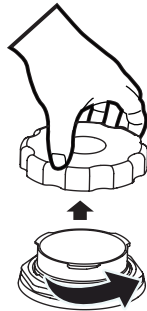

Remove the cap of the salt container.

3



Place the funnel (if supplied) over the mouth of the salt container, then put 1.5 kg of dishwasher salt in the container.

4

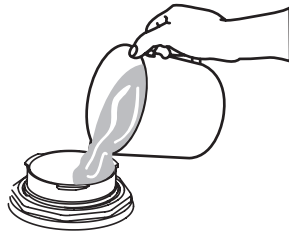

Fill the salt container to the maximum level with water.

5

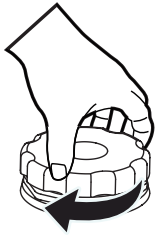

Tightly close the cap of the salt container.

⚠ CAUTION! Water and salt may come out of the salt container when you fill it. After you fill the salt container, immediately start a programme to prevent corrosion.

Filling the rinse aid dispenser

1

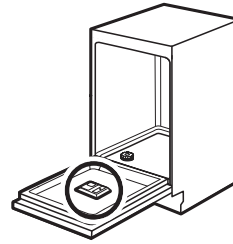

Find the rinse aid dispenser on the inside of the door.

2

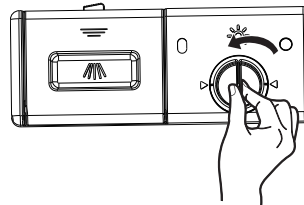

Remove the rinse aid reservoir cap by turning it counterclockwise.

3



Fill the rinse aid container with rinse aid. Be careful not to overfill.

4

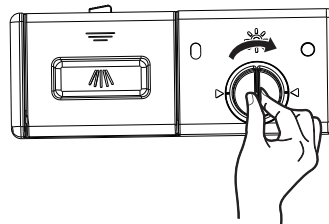

Close the rinse aid reservoir cap by turning clockwise.

Daily use

1. Open the water tap.
2. Press the On/Off button to activate the appliance.
 - If the salt indicator is on, fill the salt container.
 - If the rinse aid indicator is on, fill the rinse aid dispenser.
3. Rotate the spray arm to see if it rotates freely.
4. Load the basket and add the detergent.
5. Set and start the correct programme for the type of load and the degree of soil.

Using the detergent

1

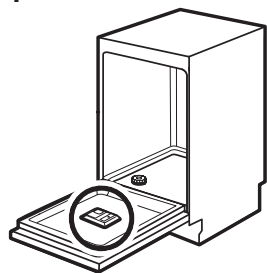

Find the detergent dispenser on the inside of the door.

2

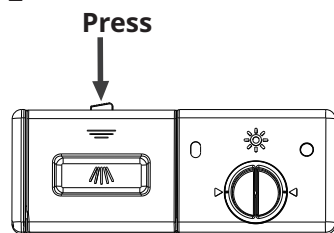

Press the release latch on the detergent dispenser to open the lid.

3

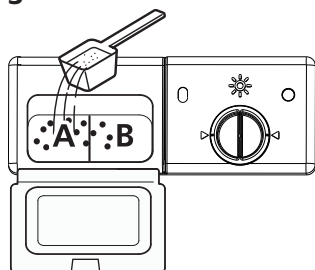

Add detergent into the larger cavity (A) for main wash. For more heavily soiled loads, also add some detergent into the smaller cavity (B) for release during pre-wash.

4

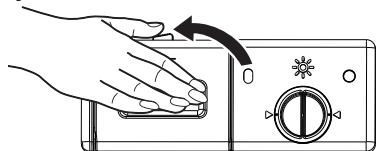

Close the lid and press it down until it locks into place.

The auto off function

This function decreases energy consumption by automatically deactivating the appliance when it is not operating.

The function comes into operation:

- 15 minutes after the completion of the programme.
- After 15 minutes if the programme has not started.

Starting a programme

⚠ CAUTION! Do not remove the baskets from the dishwasher before a wash cycle is completed.

1. Draw out the lower and upper baskets, load the dishes and push them back in. It is recommended to load the lower basket first, then the upper one.
2. Pour in the detergent.
3. Insert the plug into the socket. For the power supply, refer to the rating plate on the inside of the appliance door. Make sure that the water supply is turned on to full pressure.
4. Close the door, then press the On/Off button.
5. Choose a programme, the corresponding light will turn on. Then press the Start/Pause button, the dishwasher will start its cycle.

Starting a programme with delay start

1. Close the appliance door and set a programme.
2. Press  repeatedly until the display shows the delay time you want to set (3h/6h/9h). The delay indicator turns on.
3. Press Start/Pause to start the countdown.

While a countdown is running it is possible to increase the delay time but also change the selection of the programme and options. Make sure you press the Start/Pause button first.

When the countdown is completed, the programme starts.

Opening the door while the appliance operates

Opening the door while a programme is running stops the appliance. It may affect the energy consumption and the programme duration.

After closing the door, the appliance will resume operation within 10 seconds.

Cancelling the delay start while the countdown operates

When you cancel the delay start you have to set the programme and options again.

Press the On/Off button to deactivate the appliance. The delay start will be cancelled.

Cancelling the programme

Press the On/Off button to deactivate the appliance. Or open the door to stop running the programme, and wait a few seconds until the appliance completely stops, then press the On/Off button. The programme will be cancelled. Make sure that there is detergent in the detergent dispenser before you start a new programme.

End of the programme

1. Press the On/Off button or wait for the auto off function to automatically deactivate the appliance. If you open the door before the activation of auto off, the appliance is automatically deactivated.
2. Close the water tap.

The appliance will beep for 8 seconds when the programme is completed, then the appliance will enter standby.

If you open the door while the appliance is beeping, the appliance will enter standby immediately.

Changing the programme mid-cycle

A programme can only be changed if it has been running only for a short period of time, otherwise the detergent may have been released or the water with detergent is already drained. In this case, the dishwasher needs to be reset and the detergent dispenser must be refilled. To reset the dishwasher, follow the instructions below:

1. With the appliance door closed, press the Start/Pause button.
2. Press Programme button for more than 3 seconds to cancel the current programme. The machine will be in programme selection mode.
3. You can change the programme to the desired cycle setting.

Forget to add a dish?

A forgotten dish can be added at any time before the detergent dispenser opens. In that case, follow these steps:

1. Press the Start/Pause button to pause the cycle.
2. When the spray arms have stopped working, you can open the door completely.
3. Add the forgotten dishes.
4. Close the door.
5. Press the Start/Pause button, and the dishwasher will start after 10 seconds.

Adjusting the upper basket

The height of the upper basket can be easily adjusted to accommodate taller dishes in either the upper or lower basket.

IMPORTANT: Remove all items before adjusting the basket. The basket must be empty.

To adjust the height of the upper basket, follow these steps:

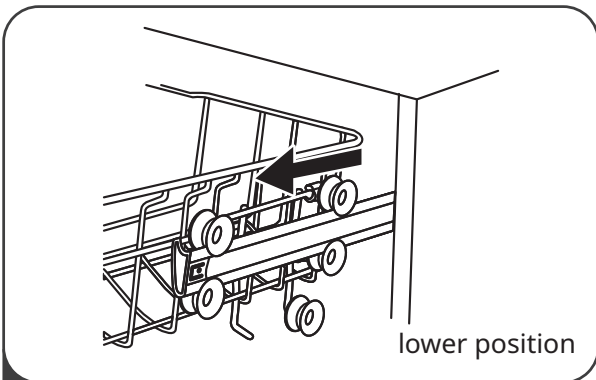

- 1 Pull out the upper basket.

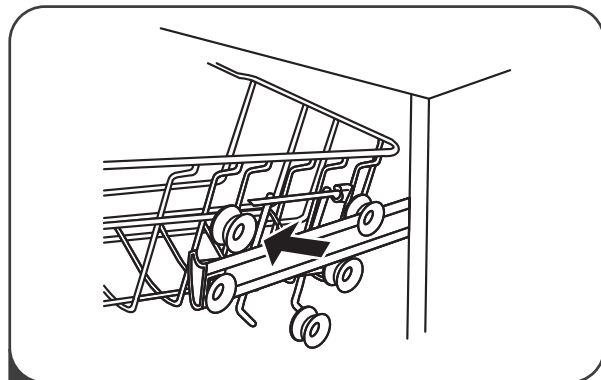

- 2 Remove the upper basket.

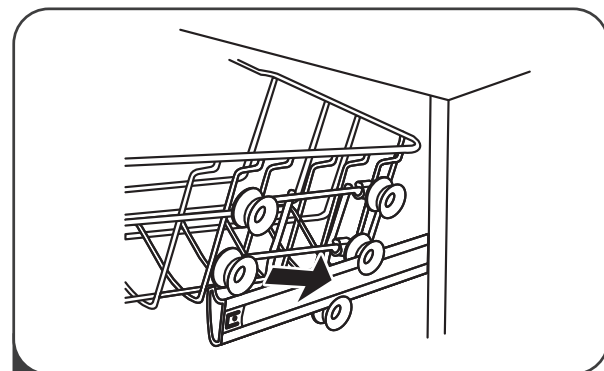

- 3 Re-attach the upper basket to upper or lower rollers.

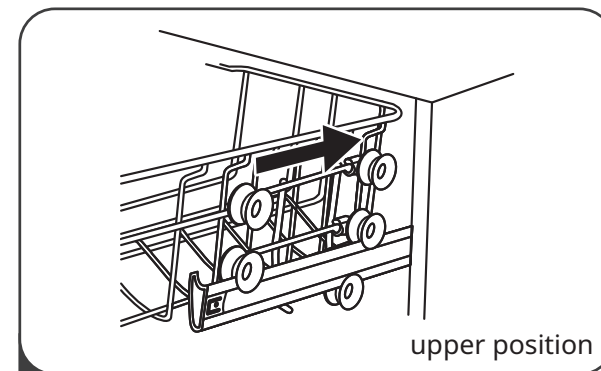

- 4 Push in the upper basket.

Adjustable cup shelf

The cup shelf in the upper basket can be unfolded to make room for taller dishes. Pull the cup shelf up to unfold it.



Adjustable lower basket

The spikes of the lower basket can be folded to make room for large dishes. Push the spikes of the lower basket down to fold the spikes.

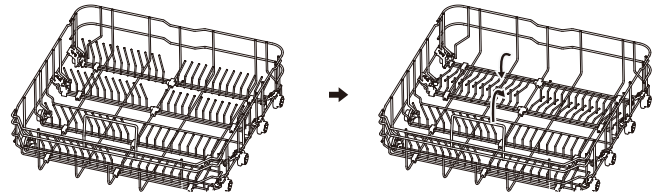

Hints and tips

General

The following hints will ensure optimal cleaning and drying results in daily use and also help to protect the environment.

- Remove larger residues of food from the dishes into the waste bin.
- Do not pre-rinse dishes by hand. When needed, use the prewash programme (if available) or select a programme with a prewash phase.
- When loading the appliance, make sure that the dishes can be completely reached and washed by the water released from the spray arm nozzles. Make sure that items do not touch or cover each other.
- You can use dishwasher detergent, rinse aid and salt separately or you can use the multi-tablets (e.g. "3 in 1", "4 in 1", "All in 1"). Follow the instructions written on the packaging.
- Select the programme according to the type of load and degree of soil. With the ECO programme you have the most efficient use of water and energy consumption for crockery and cutlery with normal soil.

Using salt, rinse aid and detergent

- Only use salt, rinse aid and detergent for dishwasher. Other products can cause damage to the appliance.
- In areas with hard and very hard water we recommend to use plain dishwasher detergent (powder, gel, tablets containing no additional agents), rinse aid and salt separately for optimal cleaning and drying results.
- At least once a month run the appliance with the use of appliance cleaner which is particularly suitable for this purpose.
- Detergent tablets do not fully dissolve with short programmes. To prevent detergent residues on the tableware, we recommend that you use the tablets with long programmes.
- Do not use more than the correct quantity of detergent. Refer to the instructions on the detergent packaging.

What to do if you want to stop using multi-tablets

Before you start to use separately detergent, salt and rinse aid do the following procedure.

1. Set the highest level of the water softener.
2. Make sure that the salt and rinse aid containers are full.
3. Start the shortest programme with a rinsing phase. Do not add detergent and do not load the baskets.
4. When the programme is completed, adjust the water softener according to the water hardness in your area.
5. Adjust the released quantity of rinse aid.
6. Activate the rinse aid empty notification.

Loading the baskets

i Refer to examples of the load of the baskets on page 15.

- Only use the appliance to wash items that are dishwasher-safe.
- Do not put in the appliance items made of wood, aluminium, pewter and copper.
- Do not put in the appliance items that can absorb water (sponges, household cloths).
- Remove remaining food from the items.
- Soak items with remaining burned food in water.
- Put hollow items (cups, glasses and pans) with the opening down.
- Make sure that cutlery and dishes do not bond together. Mix spoons with other cutlery.
- Make sure that glasses do not touch each other.
- Put small items in the cutlery basket.
- Put light items in the upper basket. Make sure that the items do not move.

Before starting a programme

Make sure that:

- The filters are clean and correctly installed.
- The cap of the salt container is tight.
- The spray arms are not clogged.
- There is dishwasher salt and rinse aid (unless you use multi-tablets).

- The position of the items in the baskets is correct.
- The programme is applicable for the type of load and for the degree of soil.
- The correct quantity of detergent is used.

1. Let the dishes cool down before you remove them from the appliance. Hot dishes are easily damaged.
2. First remove items from the lower basket then the upper basket.

Unloading the baskets

i For better drying results keep the appliance door ajar for some minutes before you remove the dishes.

i At the end of the programme water can still remain on the sides and on the door of the appliance.

Examples of basket loads

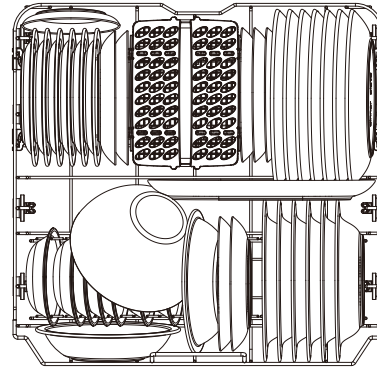
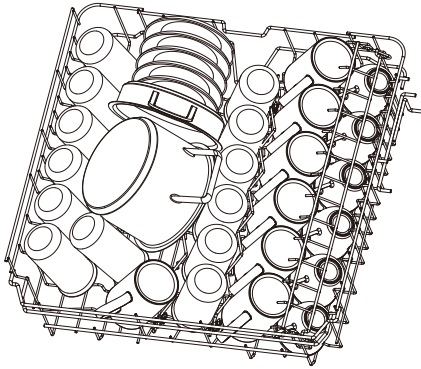

Cutlery rack

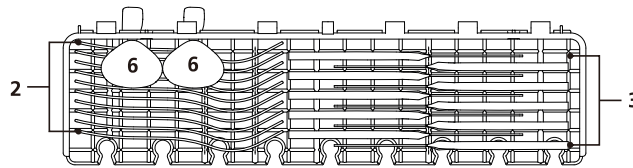

Cutlery basket

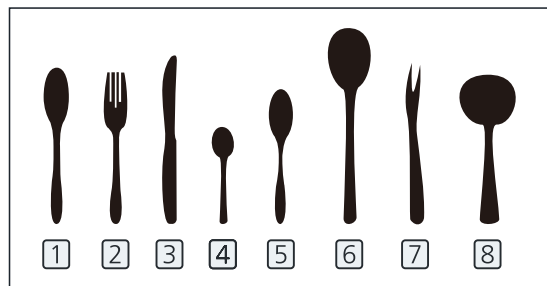
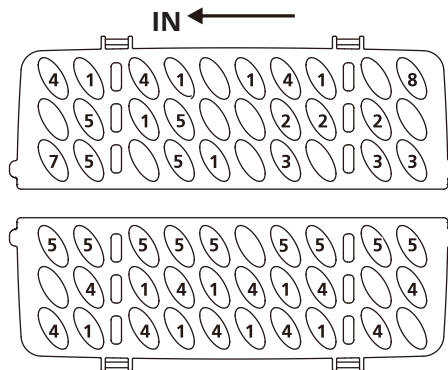

Care and cleaning

⚠ WARNING! Before maintenance, deactivate the appliance and disconnect the mains plug from the main socket.

i Dirty filters and clogged spray arms decrease the washing results. Make a check regularly and, if necessary, clean them.

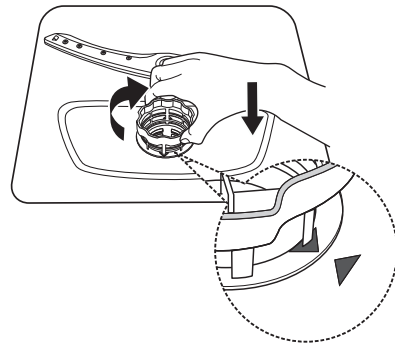

Cleaning the filters

1. Turn the filter counterclockwise to unlock it, then lift it out of the appliance.

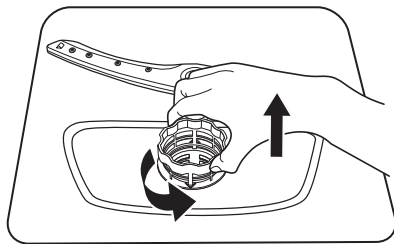

2. Grasp B firmly, then use your thumbs to press on the top of the widest bar and pull out A.

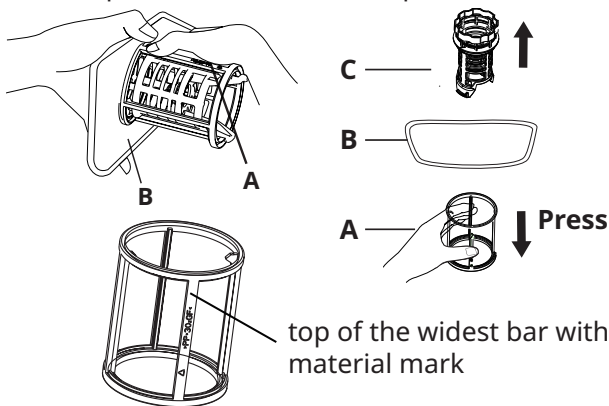

3. Rinse the filter under running water to remove larger food remnants. For more thorough cleaning, use a soft cleaning brush.

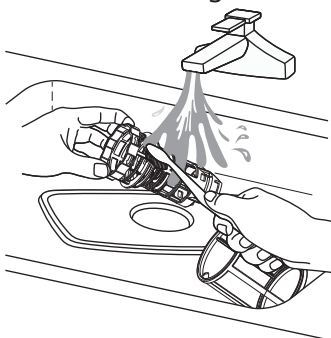

4. Reassemble the filters in the reverse order of disassembly, replace the filter insert, and turn clockwise to the close arrow.

Cleaning the spray arms

We recommend to clean the upper and lower spray arms regularly to prevent clogging. Clogged holes can cause unsatisfactory washing results.

1. Pull out the upper and lower baskets.
2. To disengage the upper spray arm from the upper basket, hold the nut in the center position of the upper spray arm and turn the spray arm counterclockwise to remove.

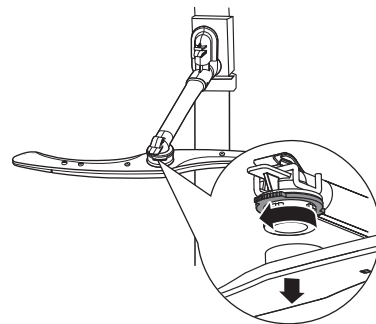

3. To detach the lower spray arm from the bottom of the appliance, just pull it up to remove.

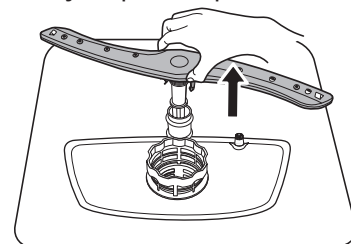

4. Rinse the upper and lower spray arms under running water. Use a thin pointed tool (e.g. a toothpick) to remove particles of soil from the holes of the spray arms.

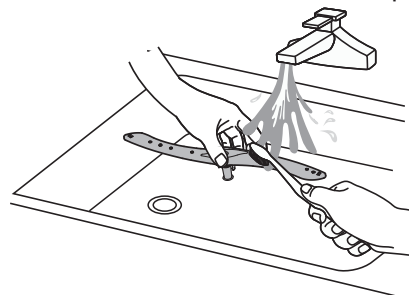

5. After cleaning, replace the spray arms.
To attach the upper spray arm to the upper basket, align the center position of the upper spray arm with the nut then turn it clockwise to tighten.
To attach the lower spray arm to the bottom of the appliance, insert the lower spray arm into position.

External cleaning

- Clean the appliance with a moist soft cloth.
- Only use neutral detergents.
- Do not use abrasive products, abrasive cleaning pads or solvents.

Internal cleaning

- Carefully clean the appliance, including the rubber gasket of the door, with a soft damp cloth.
- To maintain the performance of your appliance, use a cleaning product designed specifically for dishwashers at least once a month. Carefully follow the instructions on the packaging of the product.
- Do not use abrasive products, abrasive cleaning pads, sharp tools, strong chemicals, scourer or solvents.
- Using short-duration programmes regularly can cause grease and limescale buildup inside the appliance.
- Run long-duration programmes at least twice a month to prevent the buildup.

Frost precaution

Please take frost protection measures on the dishwasher in winter. After each washing cycle, please operate as follows:

1. Cut off the electrical power to the dishwasher at the supply source.
2. Turn off the water supply and disconnect the water inlet pipe from the water valve.
3. Drain the water from the inlet pipe and water valve. (Use a pan to collect the water)
4. Reconnect the water inlet pipe to the water valve.
5. Remove the filter at the bottom of the tub and use a sponge to soak up the water in the sump.

Moving the appliance

If the appliance must be moved, try to keep it in the vertical position. If absolutely necessary, it can be positioned on its back.

When not in use for a long time

It is recommended that you run a wash cycle with the dishwasher empty and then remove the plug from the socket, turn off the water supply and leave the door of the appliance slightly open. This will help the door seals to last longer and prevent odors from forming within the appliance.

Troubleshooting

If the appliance does not start or it stops during operation, first check if you can solve the problem by yourself with the help of the information in the table or contact an Authorised Service Centre.



WARNING! Repairs not properly done may result in serious risk to the safety of the user. Any repairs must be performed by qualified personnel.

Problem	Possible cause and solution
You cannot activate the appliance.	<ul style="list-style-type: none"> • Make sure that the mains plug is connected to the mains socket. • Make sure that there is no damaged fuse in the fuse box.
The programme does not start.	<ul style="list-style-type: none"> • Make sure that the appliance door is closed. • If the delay start is set, cancel the setting or wait for the end of the countdown. • The appliance has started the procedure to recharge the resin inside the water softener. The duration of the procedure is approximately 5 minutes.
The appliance does not fill with water.	<ul style="list-style-type: none"> • Make sure that the water tap is open. • Make sure that the pressure of the water supply is not too low. For this information, contact your local water authority. • Make sure that the water tap is not clogged. • Make sure that the filter in the inlet hose is not clogged. • Make sure that the inlet hose has no kinks or bends.
The appliance does not reach the required temperature.	<ul style="list-style-type: none"> • Heating element malfunctions. Contact an Authorised Service Centre.

Problem	Possible cause and solution
The appliance does not drain the water.	<ul style="list-style-type: none"> • Make sure that the sink spigot is not clogged. • Make sure that the filter in the outlet hose is not clogged. • Make sure that the interior filter system is not clogged. • Make sure that the drain hose has no kinks or bends.
The appliance stops and starts more times during operation.	<ul style="list-style-type: none"> • It is normal. It provides optimal cleaning results and energy savings.
The programme lasts too long.	<ul style="list-style-type: none"> • If the delayed start option is set, cancel the delay setting or wait for the end of the countdown.
The remaining time in the display increases and skips nearly to the end of programme time.	<ul style="list-style-type: none"> • This is not a defect. The appliance is working correctly.
Small leak from the appliance door.	<ul style="list-style-type: none"> • The appliance is not levelled. Loosen or tighten the adjustable feet (if applicable). • The appliance door is not centred on the tub. Adjust the rear foot (if applicable).
The appliance door is difficult to close.	<ul style="list-style-type: none"> • The appliance is not levelled. Loosen or tighten the adjustable feet (if applicable). • Parts of the tableware are protruding from the baskets.
Rattling/knocking sounds from inside the appliance.	<ul style="list-style-type: none"> • The tableware is not properly arranged in the baskets. Refer to basket loading section. • Make sure that the spray arms can rotate freely.
The appliance trips the circuit-breaker.	<ul style="list-style-type: none"> • The amperage is insufficient to supply simultaneously all the appliances in use. Check the socket amperage and the capacity of the meter or turn off one of the appliances in use. • Internal electrical fault of the appliance. Contact an Authorised Service Centre.

 Refer to "**Before first use**", "**Daily use**", or "**Hints and tips**" for other possible causes.

Once problem occurs on the appliance, deactivate and activate the appliance. If the problem occurs again, contact an Authorised Service Centre.

The washing and drying results are not satisfactory







Problem	Possible cause and solution
Poor washing results.	<ul style="list-style-type: none"> • Refer to "Daily use", "Hints and tips" and basket loading section. • Use more intensive washing programmes. • Clean spray arm jets and filter. Refer to "Care and cleaning".
Poor drying results.	<ul style="list-style-type: none"> • Tableware has been left for too long inside a closed appliance. • There is no rinse aid or the dosage of rinse aid is not enough. Set the rinse aid dispenser to a higher level. • Plastic items may need to be towel dried. • For the best drying performance activate the dry plus option. • We recommend to always use rinse aid, even in combination with multi-tablets.
There are whitish streaks or bluish layers on glasses and dishes.	<ul style="list-style-type: none"> • The release quantity of rinse aid is too much. Adjust the rinse aid level to a lower level. • The quantity of detergent is too much.

Problem	Possible cause and solution
There are stains and dry water drops on glasses and dishes.	<ul style="list-style-type: none"> • The released quantity of rinse aid is not sufficient. Adjust the rinse aid level to a higher level. • The quality of the rinse aid can be the cause.
The dishes are wet.	<ul style="list-style-type: none"> • The programme does not have a drying phase or has a drying phase with low temperature. • The rinse aid dispenser is empty. • The quality of the rinse aid can be the cause. • The quality of the multi-tablets can be the cause. Try a different brand or activate the rinse aid dispenser and use rinse aid and multi-tablets together.
The interior of the appliance is wet.	<ul style="list-style-type: none"> • This is not a defect of the appliance. it is caused by the humidity in the air that condenses on the walls.
Unusual foam during washing.	<ul style="list-style-type: none"> • Use the detergent for dishwashers only. • There is a leak in the rinse aid dispenser. Contact an Authorised Service Centre.
Traces of rust on cutlery.	<ul style="list-style-type: none"> • There is too much salt in the water used for washing. Refer to "The water softener". • Silver and stainless steel cutlery were placed together. Avoid to put silver and stainless steel items close together.
There are residues of detergent in the dispenser at the end of the programme.	<ul style="list-style-type: none"> • The detergent tablet got stuck in the dispenser and therefore was not completely washed away by water. • Water cannot wash away the detergent from the dispenser. Make sure that the spray arm is not blocked or clogged. • Make sure that items in the baskets do not impede the lid of the detergent dispenser from opening.
Odours inside the appliance.	<ul style="list-style-type: none"> • Refer to "Internal cleaning".
Limescale deposits on the tableware, on the tub and on the inside of the door.	<ul style="list-style-type: none"> • The level of salt is low, check the refill indicator. • The cap of the salt container is loose. • Your tap water is hard. Refer to "The water softener". • Even using multi-functional tabs use salt and set regeneration of the water softener. Refer to "The water softener". • If limescale deposits still remain, clean the appliance with appliance cleaners which are particularly suitable for this purpose. • Try different detergent. • Contact the detergent manufacturer.
Dull, discoloured or chipped tableware.	<ul style="list-style-type: none"> • Make sure that only dishwasher-safe items are washed in the appliance. • Load and unload the basket carefully. Refer to load of basket at the end of this user manual. • Place delicate items in the upper basket.

 Refer to "**Before first use**", "**Daily use**" or "**Hints and tips**" for other possible causes.

Error indications

If there is a malfunction the dishwasher will give an error indication. The following table shows possible error indications and their causes.

Error indication	Meaning	Possible cause and solution
The  indicator flashes quickly	Longer inlet time.	Faucet is not opened, or water intake is restricted, or water pressure is too low.
The  and  indicators flash quickly	Not reaching required temperature.	Malfunction of heating element.
The  indicator flashes quickly	Overflow.	Some element of the dishwasher leaks.
The ECO,  and  indicators flash quickly	Failure of communication between the main circuit board and display circuit board.	Open circuit or broken wiring for the communication.

⚠ WARNING!

- If overflow occurs, turn off the main water supply before calling a service.
- If there is water in the base pan because of an overflow or small leak, the water should be removed before restarting the dishwasher.
- If there is an error that cannot be solved, please request professional assistance.

Technical information (EN60436)

Supplier name	IKEA of Sweden AB
Supplier address	IKEA of Sweden AB, Tulpanvägen 8, 343 81 Älmhult, Sweden
Product type	Dishwasher
Installation type	Freestanding
Dimensions (W x H x D)	60 x 85 x 60 cm
Rated capacity ^{a)} (ps)	13 ^{b)}
Energy efficiency class ^{a)}	E
EEI ^{a)}	55,9
Cleaning performance index ^{a)}	1,125
Drying performance index ^{a)}	1,065
Energy consumption per cycle ^{c)}	0,937 kWh
Water consumption per cycle ^{d)}	11 litres
Program duration ^{a)}	3:50 (h:min)
Airborne acoustical noise emission ^{a)}	47 dB(A)
Airborne acoustical noise emission class ^{a)}	C
Off-mode	0,49 W
Delay start	1,00 W

a) For the eco program.

b) The maximum number of place settings to be washed is 13. Refer to examples of the load of the baskets at the begin of this quick guide. Correct loading will contribute to energy and water savings. The Dishes may not clean with incorrect loading.

c) Energy consumption in kWh per cycle, based on the eco programme using cold water fill. Actual energy consumption will depend on how the appliance is used.

d) Water consumption in litres per cycle, based on the eco program. Actual water consumption will depend on how the appliance is used and on the hardness of the water.

i The article number and serial number are shown on the rating plate on the internal right side of the appliance door.

Article Number

XXXXXXXX (8-digit code)



Serial No.:XXXXXXXX

Serial Number
(22-digit code)

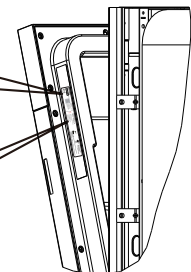

Picture for reference only

Link to EU EPREL Database

The QR code on the energy label supplied with the appliance provides a web link to the registration of this appliance in the EU EPREL database. Keep the energy label for reference together with the user manual and all other documents provided with this appliance.

It is possible to find information related to the performance of the product in the EU EPREL database using the link <https://eprel.ec.europa.eu> and the model name and product number that you can find on the rating plate of the appliance. Refer to the chapter "Product description".

For more detailed information about the energy label, visit www.theenergylabel.eu.

Environmental concerns

Recycle materials with the symbol . Put the packaging in relevant containers to recycle it. Help protect the environment and human health by recycling waste of electrical and electronic appliances.

Do not dispose of appliances marked with the symbol  with the household waste. Return the product to your local recycling facility or contact your municipal office.

IKEA guarantee

How long is the IKEA guarantee valid?

This guarantee is valid for five (5) years from the original date of purchase of your appliance at IKEA. The original sales receipt is required as proof of purchase. If service work is carried out under guarantee, this will not extend the guarantee period for the appliance.

Which LAGAN appliances are not covered by the IKEA 5-year guarantee?

LAGAN appliances purchased from IKEA before 1 May 2026 are covered by a 2-year guarantee, starting from the original date of purchase.

Who will execute the service?

IKEA service provider will provide the service through its own service operations or authorized service partner network.

What does this guarantee cover?

The guarantee covers faults of the appliance, which have been caused by faulty construction or material faults from the date of purchase from IKEA. This guarantee applies to domestic use only. The exceptions are specified under the headline "What is not covered under this guarantee?" Within the guarantee period, the costs to remedy the fault e.g. repairs, parts, labour and travel will be covered, provided that the appliance is accessible for repair without special expenditure. On these conditions the EU guidelines (Nr.99/44/EG) and the respective local regulations are applicable. Replaced parts become the property of IKEA.

What will IKEA do to correct the problem?

IKEA appointed service provider will examine the product and decide, at its sole discretion, if it is covered under this guarantee. If considered covered, IKEA service provider or its authorized service partner through its own service operations, will then, at its

sole discretion, either repair the defective product or replace it with the same or a comparable product.

What is not covered under this guarantee?

- Normal wear and tear.
- Deliberate or negligent damage, damage caused by failure to observe operating instructions, incorrect installation or by connection to the wrong voltage, damage caused by chemical or electro-chemical reaction, rust, corrosion or water damage including but not limited to damage caused by excessive lime in the water supply, damage caused by abnormal environmental conditions.
- Consumable parts including batteries and lamps.
- Non-functional and decorative parts which do not affect normal use of the appliance, including any scratches and possible colour differences.
- Accidental damage caused by foreign objects or substances and cleaning or unblocking of filters, drainage systems or soap drawers.
- Damage to the following parts: ceramic glass, accessories, crockery and cutlery baskets, feed and drainage pipes, seals, lamps and lamp covers, screens, knobs, casings and parts of casings. Unless such damages can be proved to have been caused by production faults.
- Cases where no fault could be found during a technician's visit.
- Repairs not carried out by our appointed service providers and/or an authorized service contractual partner or where non-original parts have been used.
- Repairs caused by installation which is faulty or not according to specification.
- The use of the appliance in a non-domestic environment i.e. professional use.

- Transportation damages. If a customer transports the product to their home or other address, IKEA is not liable for any damage that may occur during transport. However, if IKEA delivers the product to the customer's delivery address, then damage to the product that occurs during this delivery will be covered by this guarantee.
- Cost for carrying out the initial installation of the IKEA appliance. However, if an IKEA service provider or its authorized service partner repairs or replaces the appliance under the terms of this guarantee, the service provider or its authorized service partner will reinstall the repaired appliance or install the replacement, if necessary.

This restriction do not apply to fault-free work carried out by a qualified specialist using our original parts in order to adapt the appliance to the technical safety specifications of another EU country.

How country law applies

The IKEA guarantee gives You specific legal rights, which covers or exceed local demands. However these conditions do not limit in any way consumer rights described in the local legislation.

Area of validity

For appliances which are purchased in one EU country and taken to another EU country, the services will be provided in the framework of the guarantee conditions normal in the new country. An obligation to carry out services in the framework of the guarantee exists only if the appliance complies and is installed in accordance with:

- the technical specifications of the country in which the guarantee claim is made;
- the Assembly Instructions and User Manual Safety Information.

The dedicated After Sales Service for IKEA appliances:

Please do not hesitate to contact IKEA After Sales Service to:

make a service request under this guarantee; ask for clarification on installation of the IKEA appliance in the dedicated IKEA kitchen furniture. The service won't provide clarifications related to:

the overall IKEA kitchen installation; connections to electricity (if machine comes without plug and cable), to water and to gas since they have to be executed by an authorized service engineer.

Ask for clarification on user manual contents and specifications of the IKEA appliance.

To ensure that we provide you with the best assistance, please read carefully the Assembly Instructions and/or the User Manual section of this booklet before contacting us.

Availability of the spare parts

The following parts will be available for 7 years after this model has been discontinued: motor; circulation and drain pump; heaters and heating elements, including heat pumps (separately or bundled); piping and related equipment including all hoses, valves, filters and aquastops; structural and interior parts related to door assemblies (separately or bundled); printed circuit boards; electronic displays; pressure switches; thermostats and sensors; software and firmware including reset software.

The following parts will be available for 10 years after this model has been discontinued: door hinge and seals, other seals, spray arms, drain filters, interior racks and plastic peripherals such as baskets and lids.

For ordering the spare parts, please contact IKEA After Sales Service.

How to reach us if You need our service



Please refer to the last page of this manual for the full list of IKEA appointed contacts and relative national phone numbers.

- ⓘ In order to provide You with a quicker service, we recommend that You use the specific phone numbers listed at the end of this manual. Always refer to the numbers listed in the booklet of the specific appliance You need an assistance for. Before calling us, assure that You have to hand the IKEA article number (8 digit code) and the Serial Number (8 digit code that can be found on the rating plate) for the appliance of which you need our assistance.

- ⓘ **SAVE THE SALES RECEIPT!** It is Your proof of purchase and required for the guarantee to apply. Note that the receipt reports also the IKEA article name and number (8 digit code) for each of the appliances you have purchased.

Do you need extra help?

For any additional questions not related to After Sales of your appliances, please contact our nearest IKEA store call centre. We recommend you read the appliance documentation carefully before contacting us.

Country	Phone Number	Call Fee	Opening Time (Mon-Fri)
Deutschland	08007242420	Kostenlos	8am - 5pm
France	0805543333	Gratuit	8.30 am – 7.00 pm (lun-ven) 8.30 am – 1.00 pm (sam)
Italia	800130373	Gratuito	9am-6pm
España	900822398	Gratis	9am-6pm
Ελλάδα	0080044146128 (+30)21 6860020	Χωρίς χρέωση	9am-6pm
България	0 700 10 218	Безплатно	9.00 – 18.00 ч. (пон. - пет.)
Nederland	Local(within NL): 050-7111267 International: +31 507111267	Gratis	Ma-Vr 8-20, Za 9-20
Sverige	0775700500	Kostnadsfritt	mån-fre 8.30 - 20.00 lör-sön 9.30 - 18.00
Österreich	0800909626	Kostenlos	9am-5pm
België	080080159	Gratis	9am-5pm
Belgique		Gratuit	9am-5pm
Luxembourg		Gratuit	9am-5pm
Danmark	70 15 09 09	Gratis	man. - fre. 09.00 - 20.00 lør. - søn. 09.00 - 18.00
Norge	80031407	Gratis	9.00 am – 4.00 pm
Polska	800012088	Bezpłatne	9am-5pm
Portugal	800210151	Gratuita	9am-6pm
Česká republika	800050717	Zdarma	9am-5pm
Suomi	0800302588	Maksuton	9.00 am – 4.00 pm
Magyarország	0680984517	Ingyenes	9am-5pm
Россия	88005510448	Бесплатно	9am-6pm
Slovensko	0800160812	Bezpłatne	9.00 – 18.00 (pondelok – piatok)
Latvija	80000037	Bezmaksas	9.00 – 18.00 (P – Pk)
Eesti	8000044841	Tasuta	9.00 – 18.00 (E–R)
Lietuva	880030167	Nemokamai	9.00 – 18.00 (Pr–Pn)
United Kingdom	08009175827	free	9am till 5pm
Ireland		free	9am till 5pm
Schweiz	0800110344	Kostenlos	8am - 5pm
Suisse		Gratuit	8am - 5pm
Svizzera		Gratuito	8am - 5pm
Србија	IKEA.com	Besplatno	
Ísland	IKEA.com	Ókeypis	
România	IKEA.com	Gratuit	
Hrvatska	IKEA.com	Ne naplaćuje se	
Slovenija	IKEA.com	Brezplačno	
Tenerife	IKEA.com	Gratis	

