

FRILLESBO

en



Design and Quality
IKEA of Sweden

ENGLISH

5

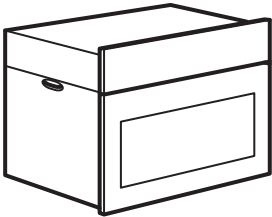
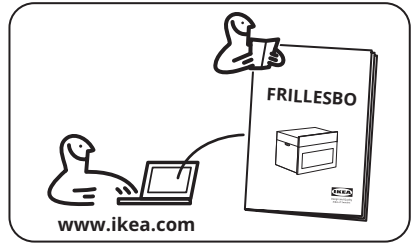
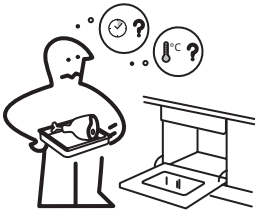

1x

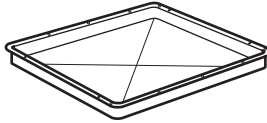

1x



1x

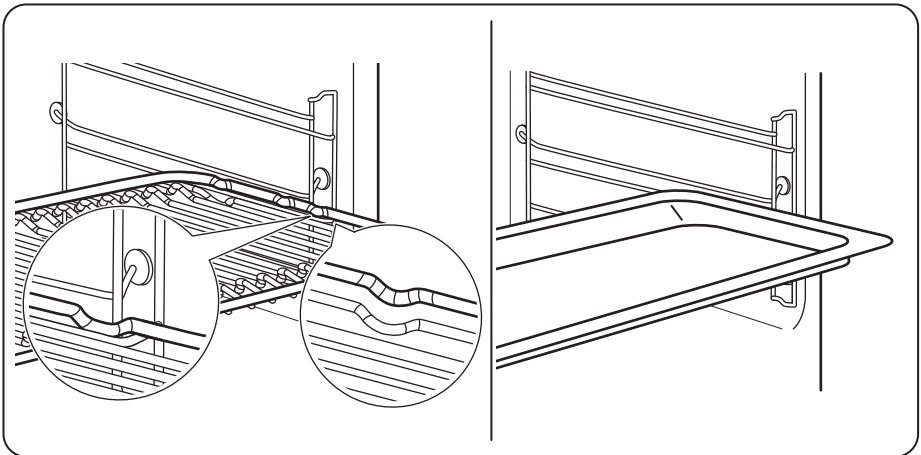

START

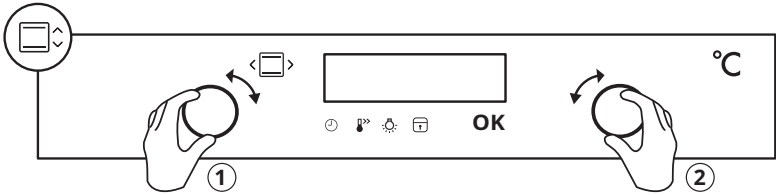
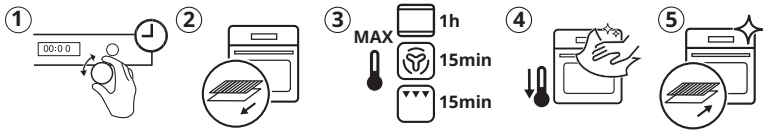
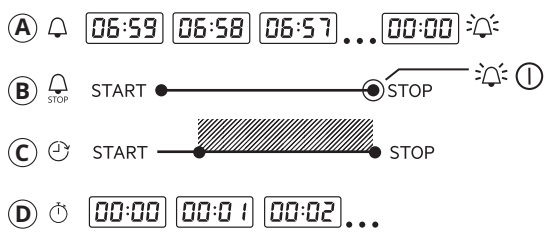
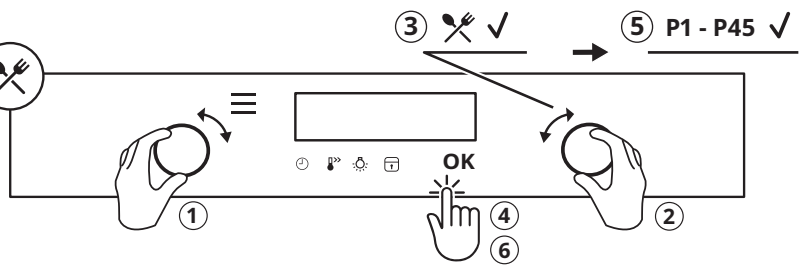
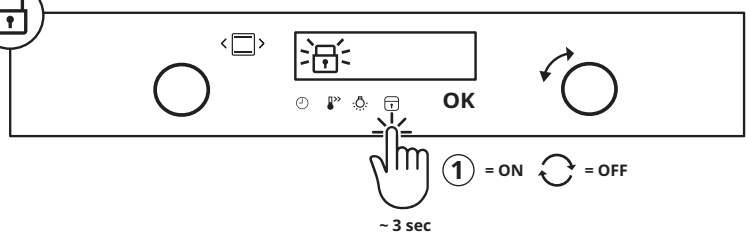
Product description

General overview

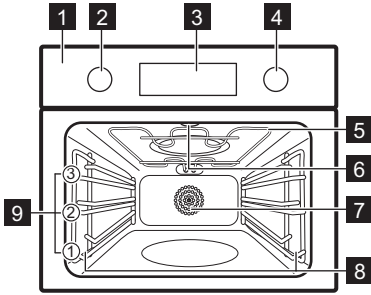

- 1 Control panel
- 2 Knob for the heating functions
- 3 Display
- 4 Control knob
- 5 Heating element
- 6 Lamp
- 7 Fan
- 8 Shelf support, removable
- 9 Shelf positions

Control panel

Turning the appliance on and off

To turn on the appliance:

1. Press the knobs. The knobs come out.
2. Turn the knob for the heating functions to select a function.
3. Turn the control knob to adjust settings.

To turn off the appliance: turn the knob for the heating functions to the off position **0**.

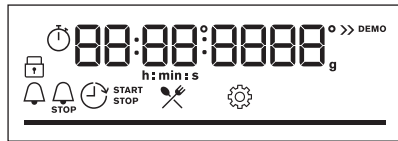

Control panel overview

	Press to set timer functions.
	Press and hold to set the function: Fast Heat Up.
	Press to turn the appliance lamp on and off.
	Press and hold to set the function: Lock.
OK	Press to confirm your selection.









	The appliance is locked.
	Submenu: Assisted Cooking.
	Submenu: Settings
	Fast Heat Up is activated.
	Minute minder is activated.
	Cooking time is activated.
	Time Delayed Start is activated.
	Uptimer is activated.
	Progress bar - visually indicates when the appliance reaches the set temperature or when the cooking time comes to an end.

Display indicators

Display with key functions:

Daily use

Heating functions

	True Fan Cooking: Even baking, tenderness, drying
	Conventional Cooking: Traditional baking
	Frozen Foods: French fries, potato wedges, spring rolls
	Pizza Function: Baking pizza
	Bottom Heat: Baking cakes
	Defrost: Defrosting
	Moist Fan Baking: Baking
	Grill: Toasting, grilling
	Turbo Grilling: Roasting meat, browning

The lamp may turn off automatically at a temperature below 80°C during some oven functions.

Notes on: Moist Fan Baking

This function was used to comply with the energy efficiency class and ecodesign requirements (according to EU 65/2014 and EU 66/2014). Tests according to: IEC/EN 60350-1.

The oven door should be closed during cooking so that the function is not interrupted and the oven operates with the highest energy efficiency possible.



When you use this function the lamp automatically turns off after 30 sec.

This function is designed to save energy during cooking. When you use this function, the temperature in the cavity may differ from the set temperature. The heating power may be reduced.

Entering: Menu



Open the Menu to access Assisted Cooking dishes and settings.

























1. Turn the knob for the heating functions to .































The display shows , .











2. Turn the control knob and select the icon to enter submenu. Press OK.

Submenu: Assisted Cooking

Legend	
	Weight adjustment available.
	Preheat the appliance before you start cooking.
	Shelf level. Refer to Product description.

P1	Roast beef, rare  2
P2	Roast beef, medium  2
P3	Roast beef, well-done  2
P4	Steak, medium  2
P5	Beef roast / braised   1
P6	Roast beef, rare LTC*  2
P7	Roast beef, medium LTC*  2
P8	Roast beef, well-done LTC*   2
P9	Fillet, rare  2
P10	Fillet, medium  2
P11	Fillet, well-done  2
P12	Veal roast   1
P13	Pork roast (e.g. neck or shoulder)  1
P14	Pulled pork  2
P15	Pork loin, fresh  1
P16	Spare ribs  2
P17	Lamb leg with bones  1
P18	Chicken, whole  1
P19	Chicken, half   2
P20	Chicken breast  2

P21	Chicken legs, fresh  2
P22	Duck, whole   1
P23	Goose breast  2
P24	Meat loaf  1
P25	Fish, whole, grilled  2
P26	Fish fillet   3
P27	Cheesecake  3
P28	Apple cake, covered   2
P29	Apple tart  2
P30	Apple pie   2
P31	Brownies   2
P32	Muffins   2
P33	Loaf cake  1
P34	Baked potatoes   2
P35	Wedges   2
P36	Grilled mixed vegetables  2
P37	Croquettes, frozen   2
P38	French fries   2
P39	Lasagna with dry pasta sheets   1

P40	Potato gratin  1
P41	Pizza fresh, thin crust   1
P42	Pizza fresh, thick crust   1
P43	Quiche lorraine   1
P44	Baguette / Ciabatta / White bread   2
P45	Whole grain / Rye / Dark bread   1

*LTC - Low Temperature Cooking

Submenu: Settings

	Setting	Value
01	Time of day	Change
02	Display brightness	1 - 5
03	Key tones	1 - Beep, 2 - Click, 3 - Sound off
04	Buzzer volume	1 - 4
05	Uptimer	On / Off
06	Light	On / Off
07	Fast Heat Up	On / Off
08	Demo mode	-
09	Software version	Check
10	Reset all settings	Yes / No

Troubleshooting

If you encounter an issue with your appliance, check Troubleshooting in the full

version of the User Manual available on: www.ikea.com.

Energy efficiency

Product information sheet and product information according to EU and UK energy labelling and ecodesign regulations

Supplier's name	IKEA
Model identification	FRILLESBO 706.140.72
Energy efficiency index	80.8

Energy efficiency class	A+
Energy consumption with a standard load, conventional mode	0.99 kWh/cycle
Energy consumption with a standard load, fan-forced mode	0.59 kWh/cycle
Number of cavities	1
Heat source	Electricity
Volume	43 l
Type of oven	Built-in oven
Mass	34.0 kg
IEC/EN 60350-1 - Household electric cooking appliances - Part 1: Ranges, ovens, steam ovens and grills - Methods for measuring performance.	

Product information for power consumption and maximum time to reach applicable low power mode

Power consumption in standby	0.8 W
Maximum time needed for the equipment to automatically reach the applicable low power mode	20 min



701138131-A-372025

