

Brief and handy: everything your dishwasher needs ...
 Before using for the first time, read the operating instructions!

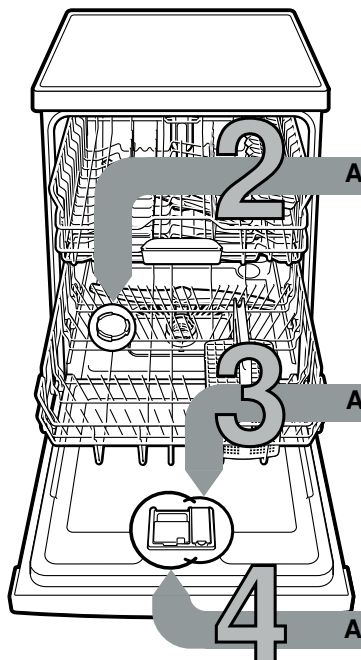

1

Adjusting the water softening system *

Ask your water supply company what the water hardness is and enter ...

Water hardness value Clarke	Hardness range	mmol/l	Factory setting
0-8	soft	0-1.1	H:00
9-10	soft	1.2-1.4	H:01
11-12	medium	1.5-1.8	H:02
13-15	medium	1.9-2.1	H:03
16-20	medium	2.2-2.9	H:04
21-26	hard	3.0-3.7	H:05
27-38	hard	3.8-5.4	H:06
39-62	hard	5.5-8.9	H:07

* only before the first wash or if the water hardness has changed

Quickly done ...
How to adjust
 - Switch on the ON/OFF switch.
 Press and hold the **Setup 3 sec.** button for 3 seconds.
 In the display window you will see the factory setting H:04 and **set**
 Adjust the setting using the buttons - and +.
 - Press and hold the **Setup 3 sec.** button for 3 seconds.
 The chosen setting has now been stored in your dishwasher.

Add special salt

Dissolves limescale (not necessary when set to 0!) ...

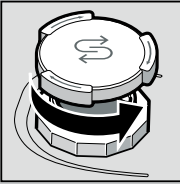

Open the lid.

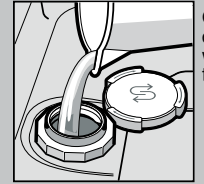

Only fill the salt dispenser with water before the first wash.

For optimal washing results

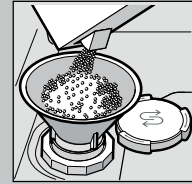

Add special salt (never use detergent!).

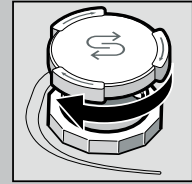

Close the lid. Rinse immediately.

Add rinse aid

Gets it sparkling clean ...

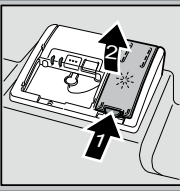

Press marking 1, lift lid 2.



For optimum drying results

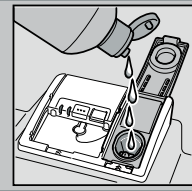

Add rinse aid.

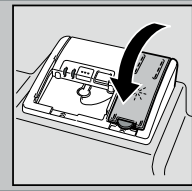

Close lid. CLICK!

Add detergent

A lot of dirt, a lot of detergent ...

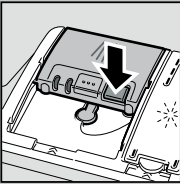

If required, open the cover (press button).

Attention: Combination products are not suitable for all programmes, follow manufacturer's instructions.

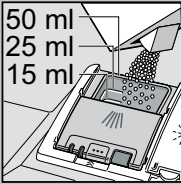
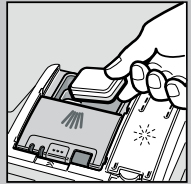

Pour detergent into the dry detergent dispenser only.

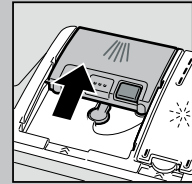

Slide cover shut, press. PLOP!

5 Switch on the appliance

6 Select a programme



7 Switch on the appliance. Here we go ...

8 Switch off the appliance Everything o.k. ...

Overview of programmes

This overview describes all the possible programmes. You can see which programmes your appliance offers from its control panel. The values given in the programme details are laboratory measurements compliant with European standard EN 60436. The consumption figures depend on the selected programme and additional functions. The programme duration will be different if the machine is short of rinse additive or the function is turned off.

* half normal load

** Suitable programme for running at night: it takes longer, but is extremely quiet.

	Intensive 70°	Auto 45°/65°	Eco 50°	Night * night	Glass 40°	65° 1h	Quick 65°	Quick 45°	Pre Rinse
Duration in hrs : mins.	2:15-2:20	1:30-2:30	3:15	3:55	1:30-1:40	1:00	1:00	0:29 *	0:15
Energy consumption in kWh	1,250-1,300	0,800-1,300	0,849	0,800	0,850-0,900	1,400	1,400	0,800	0,050
Water consumption in litres	12-15	7-18	9,5	10	11-14	11	11	10	4

You will find descriptions of possible additional functions in your instruction manual.

Maintenance and care

For perfect rinsing results ...

Cleaning waste water pump

Filters
... check, if required, clean.

Rotate filter cylinder, remove filter system ...

rinse under running water ...

insert ...

Screw on filter system
NOTE MARK!

- Pull out the mains plug.
- Remove filters and scoop out water.
- Lever off cover (A).
- Check area around the fan impeller for foreign objects.
- Click cover shut (B).
- Insert filters.

Spray arms
... Remove blockages/deposits.

pull lower arm upwards ...

unscrew upper arm ...

clean spray nozzles under running water (if required use toothpicks) ...

insert lower arm ...
screw on upper arm tightly

Rectify small faults yourself ...

... because self-help is worth it!

For more information see the instruction manual

Fault	Possible causes	Solution
Display "E:18"/"⚡" is lit *	Supply fitting jammed or furred up 	<ul style="list-style-type: none"> ▶ Open supply fitting. ▶ 1. Unscrew water connection. ▶ 2. Clean filter in the water supply. ▶ 3. Flow rate must be min. 10 l/min when water supply is open. If the flow rate is less, replace the supply fitting. ▶ Install supply hose without kinks.
Display "E:22"	Filters are soiled or blocked	▶ Clean the filters (see above).
Display "E:24" and "⚡" are lit *	Waste water hose is blocked or kinked Cover of waste water pump not attached	<ul style="list-style-type: none"> ▶ Reposition the waste water hose without kinks. ▶ Attach cover (see above).
Display "E:25" and "⚡" are lit *	Waste water pump blocked	▶ Clean waste water pump (see above).
Other error display "E:XX" is lit	Appliance technically defective	<ul style="list-style-type: none"> ▶ Call customer service (state the error displayed). ▶ Unplug the appliance. Turn off the tap.
Residual water in the appliance	Programme has not yet ended	▶ Switch on the appliance and close or terminate the programme (see Terminating the programme).

Rust on cutlery	Cutlery not rust-resistant Hard knife blades are more susceptible Extraneous rust	<ul style="list-style-type: none"> ▶ Use dishwasher-safe cutlery. ▶ Never wash rusting parts in the appliance.
-----------------	---	--

Fault	Possible causes	Solution
Tableware is not clean	Items of tableware lying against or on top of each other	▶ Separate tableware, prevent points of contact.
Sand or gritty residue on the tableware 	Not enough detergent	▶ Follow the manufacturer's instructions (detergent).
	Unsuitable programme selected	▶ Select a more intensive programme.
	Spray arm nozzles blocked	▶ Clean spray arms (see above).
	Filters are soiled, not securely positioned	▶ Clean the filters (see above).
	Spray arms blocked	▶ Arrange tableware so that spray arms can rotate freely.

Marks and streaks	Rinse aid dosage too high / too low	<ul style="list-style-type: none"> ▶ In the case of streaks: reduce detergent dosage. ▶ With water or limescale marks: increase dosage.
Tableware is not dry	Rinse aid	▶ Increase dosage. Change product.
	The combined detergent used has poor drying performance. Appliance setting	▶ Use rinse aid.
Milky deposits on the tableware (removable)	Water softening function is wrongly configured;	▶ Activate intensive drying (depending on model)
	Insufficient special salt	▶ Configure water softening system correctly.
Milky deposits, glasses clouded / opaque (cannot be removed)	Glasses not dishwasher-proof.	▶ Add special salt.
		▶ Use dishwasher-safe glasses. ▶ Use gentle detergents for glass.
Plastic / tableware items discoloured	Not enough detergent	▶ Follow the manufacturer's instructions (detergent).
	Discolouration by food colourings (tomato sauce)	▶ Discolouration will not damage the appliance; It will fade after further wash cycles.

* Depending on the model

Terminating the programme ...

Press the start button and hold for 3 seconds (Reset).



The display window shows: Program was terminated.



The programme sequence lasts approx. 1 min. The display window shows: Finished. Switch off ON/OFF switch.

Loading the dishwasher correctly ...

Dishwasher-proof utensils (not soiled with ash, wax, lubricating grease, ink or adhesive labels; remove large remnants of jam, milk products and food according to the operating instructions and check that the spray arms can rotate freely).