



A guide to buying  
IKEA kitchens

# IKEA kitchens

---

Whether you're looking for a complete kitchen system like METOD or one of our other kitchens, this buying guide includes the products, prices and helpful information you need to choose the kitchen of your dreams.

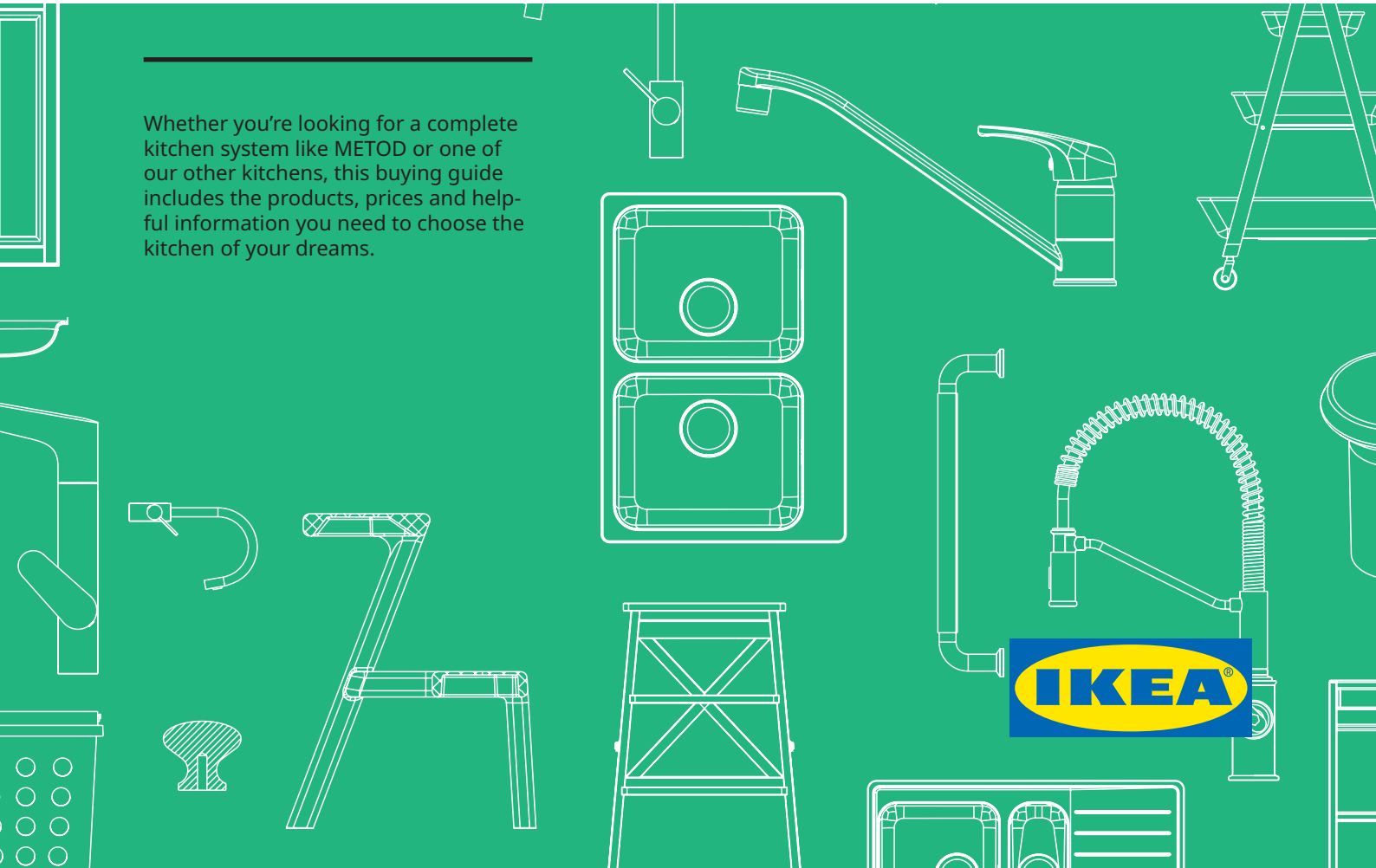

# Services

---

Our broad service offer gives you the freedom to decide how much you want to do yourself and how much you want us to do for you.

Below you'll find all the services that we can offer, visit [www.IKEA.co.uk](http://www.IKEA.co.uk) for more detail



## Kitchen planning

Get help with the planning of your new kitchen, by booking an appointment with one of our experts at IKEA. You bring the measurements and drawing or a picture of the area – we help you with inspiration and functional solutions for everything, from the placement of cabinets, appliances, islands and storage to lighting, sinks and wash-basins.

---



## Measuring

If you prefer, we measure the room and check everything, from the placement of windows, doors and power sockets to the material and condition of the walls.

---



## Delivery

Whether you're shopping in store or online, and no matter how big the purchase, we'll do the heavy lifting and bring it to your home or business. We deliver on a day and at a time that suits you.

---



## Payment options

We accept many payment methods, including cards and cash. And if you need a little longer to settle your bill, we can help you spread the cost.

---

# You can do it yourself, but you don't have to



## Kitchen installation

If you want to make things smooth and easy for you - we'll install your new kitchen and coordinate the job from start to finish. We handle all those time-consuming jobs like fitting sinks, taps and worktops. And you can rest assured that the installation of gas/electric appliances is done properly. We also take the packaging with us when your kitchen is in place.

---



## Removal and recycling

When you buy a kitchen with installation from us, we are happy to take care of your old one. Whatever can't be reused will be recycled responsibly.

---



## Assembly

All of our products are designed to be assembled by you, but we're more than happy to help put it all together, too.

---

# What type of kitchen are you looking for?

---

Whether you're looking for a complete kitchen system like METOD that you can personalise any way you want, or a simpler kitchen that you can install in a day, we have what you're looking for. Here you have four different types of IKEA kitchens to suit different needs and wishes.



## METHOD kitchen system

Our METHOD kitchen system includes cabinets in several different sizes to fit your room layout as well as your kitchen habits. The flexibility of the system offers endless of choices, giving you the freedom to customise a kitchen that's ideal for you and your space. We've also developed an extensive range of kitchen organisers and interior fittings allowing you to quickly see and reach even the things furthest back in the corner cabinets. In addition you have a vast choice in front expressions, worktops, lighting, sinks, taps, knobs, handles and much more to personalise every inch of your kitchen

**See page 08**

## ENHET kitchen

Whatever shape your homes takes, your ENHET kitchen will fit right in. Find pre-combined and affordable solutions online and assemble them without special tools – they are simply clicked together. ENHET gives you great freedom to personalise your kitchen, offering open and closed storage, a corner cabinet and doors in different colours, as well as different accessories.

**See page 50**



## KNOXHULT kitchen

KNOXHULT comes in pre-set modules that you can arrange the way you prefer. Together with our LAGAN appliances you can get a complete kitchen with all the basic functions you need at a low price. Add sink, tap, knobs and handles of your choice to complete the look. The simplicity of the pre-set modules makes the installation so easy that you can have a fully functional kitchen up and running the same day you bring it home from the IKEA store. **See page 78**



## SUNNERSTA mini-kitchen

If you like to keep it simple and don't need an elaborate kitchen, SUNNERSTA might be your treat. This flexible mini-kitchen is easy to buy, get home, install and take with you if you move somewhere else. Add TILLREDA portable induction hob and TILLREDA fridge, and you'll have the basic functions you need for a small space apartment, guest house, dorm room or wherever you might cook your next meal. **See page 82**



# METHOD kitchen system

---

## Endless possibilities

The modular design of METHOD kitchen system is easy to install and gives you endless of possibilities when designing your kitchen. Whether you have a taste for the traditional, love the minimalism in modern style or land somewhere in between, you'll surely find something that fits you.

To become truly beautiful, the kitchen has to be functional and take care of all your kitchen needs, too. With METHOD you have the freedom to get the look you want on the outside and keep everything in perfect

order on the inside. Start by deciding the style of your dream kitchen by choosing the doors and drawer fronts, lighting, worktop, sink, tap, knobs, handles and accessories that you like.

**25**

The METHOD kitchen system has a 25-year guarantee.





# METHOD doors and drawer fronts

---

## Choose your style!

No matter what your personal style and preference is, make sure to choose a kitchen front you will love for years to come. It is the face of your kitchen, and most likely you will spend many hours in it.

We have a wide range of materials and finishes to choose from to suit your style – no matter what you like! Everything from traditional doors and drawer fronts that are rich in details, to high-gloss and

modern doors and drawer fronts with integrated handles to give you that open clean look – we have it!

The process of choosing the style of your kitchen is all up to you, go for whatever you like – it is your kitchen! We have made sure that all our fronts are durable and of high quality. They all come with a 25-year guarantee to ensure, that whatever you choose it will last for years to come.

**25**

METHOD Kitchen doors have a 25-year guarantee.



# Door and drawer front styles



## Sleek doors and drawer fronts

Sleek doors offers you straight lines and smooth, easy to clean surfaces, simplicity in its truest form. Choose from a wide variety of finishes, colours and materials.



## Frame doors and drawer fronts

Frame doors and drawer fronts are rich in detail, with a crafted look and feel -they create a kitchen with a rustic and traditional look. All our frame door families have a matching glass door.



## High-gloss doors and drawer fronts

Glossy surfaces suit everyone from the minimalist to the wild family with kids. Stains are no problem as they are just as easy to wipe clean as they were to make.



## Doors and drawer fronts with integrated handles

You might not notice them at first glance – and that's the idea! Integrated handles lend a minimalistic and modern feeling to your kitchen.

## Sleek doors and drawer fronts



**ASKERSUND**

*Colour/design:* dark brown ash effect.  
*Material:* particleboard and melamine foil finish.

ASKERSUND is a dark ash wood effect door, with a grain pattern that you can see and feel. It creates a warm, modern kitchen. Complement with JUTIS accent door.

W400×H800 mm      604.252.46

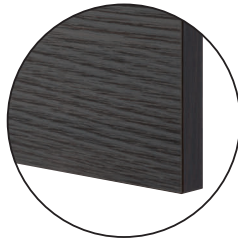

**ASKERSUND**

*Colour/design:* light ash effect.  
*Material:* particleboard and melamine foil finish.

ASKERSUND is a blonde ash wood effect door, with a grain pattern that you can see and feel. It creates a light, modern kitchen. Complement with JUTIS accent door.

W400×H800 mm      303.318.57



**BODARP**

*Colour/design:* Grey-green.  
*Material:* Particleboard and recycled foil finish.

Produced in factories using renewable electricity and featuring a foil made of recycled PET bottles, BODARP doors and drawer fronts in matt grey-green creates an open and welcoming kitchen with a modern twist. Complement with JUTIS accent door.

W400×H800 mm      804.355.36

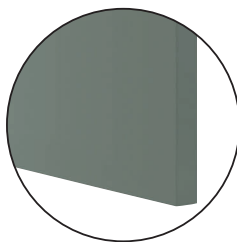

## Sleek doors and drawer fronts

---



### KUNGSBACKA

*Colour/design:* anthracite.

*Material:* particleboard and recycled plastic.

KUNGSBACKA anthracite is a door with a striking matt black finish and two chamfered edges. It's made from recycled wood and recycled plastic and brings a modern, streamlined look to your kitchen.

Complement with JUTIS accent door.

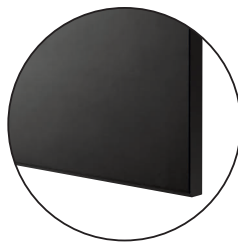

W400×H800 mm      403.373.35

---



### VEDDINGE

*Colour/design:* grey.

*Material:* fibreboard and painted finish.

VEDDINGE grey is a smooth, sleek door that gives your kitchen a soft, modern look. Complement with JUTIS accent door.

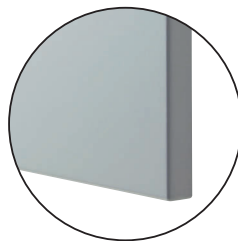

W400×H800 mm      702.210.03

---



### VEDDINGE

*Colour/design:* white.

*Material:* fibreboard and painted finish.

VEDDINGE white is a smooth, sleek door that gives your kitchen a bright, modern look. Complement with JUTIS accent door.



W400×H800 mm      002.054.31

---



## Sleek doors and drawer fronts



### SINARP

Colour/design: brown.

Material: clear lacquered oak veneer and solid oak.

SINARP offers a timeless design with a modern twist, in dark wood tones that are full of character. The solid oak edging elegantly outlines the front adding fine detail and warmth to your kitchen. Complement with SKÖVDE tempered glass doors or HASSLARP accent door.



W400×H800 mm

704.041.54

## Frame doors and drawer fronts



### AXSTAD

Colour/design: matt blue.

Material: fibreboard and foil finish.

AXSTAD kitchen door has a matt blue surface with soft lines and an inset panel. The design allows you to use it to create both a modern and traditional kitchen.

Complement with AXSTAD tempered glass doors.

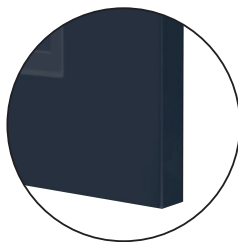

W400×H800 mm

704.752.12



### AXSTAD

Colour/design: matt white.

Material: fibreboard and foil finish.

AXSTAD door has a matt, white surface with soft lines and an inset mirror. The design allows you to use it to create both a modern and traditional kitchen.

Complement with AXSTAD tempered glass doors.



W400×H800 mm

304.087.62

## Frame doors and drawer fronts



### AXSTAD

Colour/design: dark grey.  
Material: fibreboard and foil finish.

AXSTAD kitchen door has a matt, dark grey surface with soft lines and an inset panel. The design allows you to use it to create both a modern and traditional kitchen.  
Complement with AXSTAD tempered glass doors.

W400×H800 mm      604.543.28



### BODBYN

Colour/design: grey.  
Material: fibreboard and painted finish.

Rich in detail, BODBYN grey door has a panel that is bevelled on the inside and contoured on the outside. It gives your kitchen a traditional touch.  
Complement with BODBYN tempered glass doors.

W400×H800 mm      502.210.37



### BODBYN

Colour/design: off-white.  
Material: fibreboard and painted finish.

Rich in detail, BODBYN off-white door has a panel that is bevelled on the inside and contoured on the outside. It gives your kitchen a traditional touch.  
Complement with BODBYN tempered glass doors.

W400×H800 mm      702.054.80



## Frame doors and drawer fronts

---



**STENSUND**

*Colour/design:* beige.

*Material:* fibreboard and painted finish.

STENSUND series offers a touch of country living with framed fronts and grooved panels that create a warm, crafted look. Complement with STENSUND tempered glass doors.

W400×H800 mm      004.505.59

---

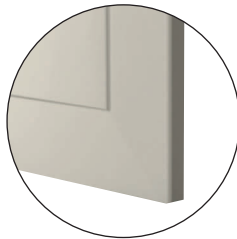

**STENSUND**

*Colour/design:* white.

*Material:* fibreboard and painted finish.

STENSUND series offers a touch of country living with framed fronts and grooved panels that create a warm, crafted look. Complement with STENSUND tempered glass doors.

W400×H800 mm      004.505.59

---



## Frame doors and drawer fronts



### LERHYTTAN

*Colour/design:* light grey.  
*Material:* tinted birch veneer and solid birch.

LERHYTTAN door has a distinct traditional character, with a solid wood frame with bevelled edges and an inset veneer panel. LERHYTTAN creates a cosy kitchen with rustic charm. Complement with LERHYTTAN tempered glass doors.

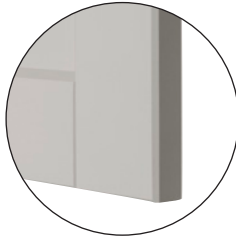

W400×H800 mm      503.524.29



### LERHYTTAN

*Colour/design:* black stained.  
*Material:* stained ash veneer and solid ash.

LERHYTTAN door has a distinct traditional character, with a solid wood frame with bevelled edges and an inset veneer panel. LERHYTTAN creates a cosy kitchen with rustic charm. Complement with LERHYTTAN tempered glass doors.

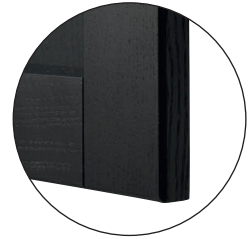

W400×H800 mm      003.560.57



### ENKÖPING

*Colour/design:* white wood effect.  
*Material:* Fibreboard and foil finish.

A classic look in white that feels inviting and will outlast the test of time. ENKÖPING framed fronts are covered in durable foil with a subtle grain structure that gives an authentic, warm wood character.



W400×H800 mm      605.057.66      €000

## High-gloss doors and drawer fronts



**KALLARP**

*Colour/design:* high-gloss dark red-brown.  
*Material:* high-gloss foil finish.

KALLARP is a high-gloss door with sleek, straight lines and brings a colourful, modern look to your kitchen.  
 Complement with JUTIS accent door.

W400×H800 mm      104.282.85

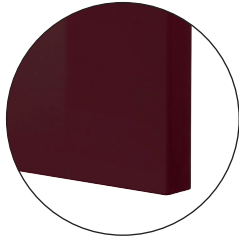

**RINGHULT**

*Colour/design:* high-gloss light grey.  
*Material:* particleboard and high-gloss foil finish.

RINGHULT light grey doors have sleek, straight lines and a high-gloss surface that's durable and easy to clean. RINGHULT brings a bright, modern look to your kitchen.  
 Complement with JUTIS accent door.

W400×H800 mm      403.271.38

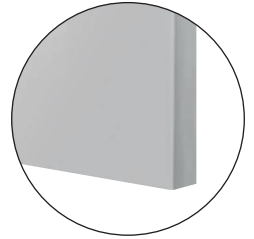

**RINGHULT**

*Colour/design:* high-gloss white.  
*Material:* particleboard and high-gloss foil finish.

RINGHULT white doors have sleek, straight lines and a high-gloss surface that's durable and easy to clean. RINGHULT brings a bright, modern look to your kitchen.  
 Complement with JUTIS accent door.

W400×H800 mm      302.050.95



**KALLARP**

*Colour/design:* high-gloss light grey-blue.  
*Material:* particleboard with foil finish.

KALLARP is a high-gloss drawer front with sleek, straight lines and brings a fresh, modern look to your kitchen.  
 Complement with JUTIS accent door.

W400×H800 mm      405.201.45

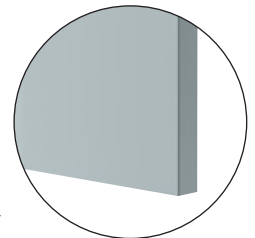

## Doors and drawer fronts with integrated handles



**VOXTORP**

*Colour/design:* high-gloss white.  
*Material:* fibreboard and high-gloss foil finish.

VOXTORP is a smooth, high-gloss door with integrated handles. It brings clean lines and an open, modern look to your kitchen. Complement with JUTIS accent door.

W400×H800 mm      203.974.86



**VOXTORP**

*Colour/design:* matt white.  
*Material:* particleboard and foil finish.

VOXTORP is a smooth, matt door with integrated handles. It brings clean lines and an open, modern look to your kitchen. Complement with JUTIS accent door.

W400×H800 mm      402.731.78



**VOXTORP**

*Colour/design:* high-gloss light beige.  
*Material:* fibreboard and high-gloss foil finish

VOXTORP is a smooth, high-gloss door with integrated handles. It brings clean lines and an open, modern look to your kitchen. Complement with JUTIS accent door.

W400×H800 mm      503.211.50

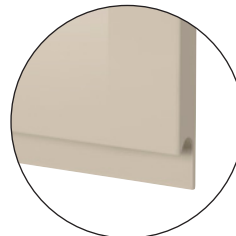

## Doors and drawer fronts with integrated handles



### VOXTORP

*Colour/design:* dark grey.  
*Material:* particleboard and foil finish.

VOXTORP is a smooth door with integrated handles. It brings clean lines and an open, modern look to your kitchen. Complement with JUTIS accent door.

W400×H800 mm 804.540.92

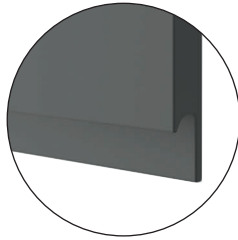

## Glass doors



### JUTIS

*Colour/design:* frosted glass and aluminium.  
*Material:* tempered glass and aluminium.

JUTIS white glass door is a chameleon that blends perfectly with all our other kitchen fronts. A perfect option if you've chosen a family of fronts with no glass doors. Handles included.

W400×H800 mm 102.058.31



### JUTIS

*Colour/design:* smoked glass and black.  
*Material:* tempered glass and aluminium.

JUTIS smoked glass door is a chameleon that blends perfectly with all our other kitchen fronts. A perfect choice if you want a family of fronts with no glass doors. Handles included.

W400×H800 mm 602.058.95



### SKÖVDE

*Colour/design:* dark bronze effect.  
*Material:* tempered glass and aluminium.

SKÖVDE bronze door is a chameleon that blends perfectly with all our other kitchen fronts. A perfect option if you've chosen a family of fronts with no glass doors. Handles included.

W400×H800 mm 204.041.80

## Accent doors

---

Accent doors are a great way to get a more personal look by adding a contrast, a pattern or a splash of colour. They're designed to complement the other doors

in your kitchen, which means they don't come in as many sizes as most fronts.

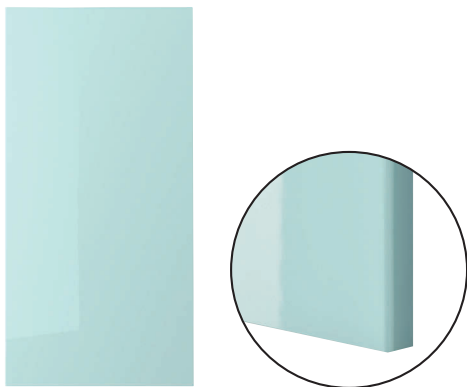

### JÄRSTA

*Colour/design:* high-gloss light turquoise.  
*Material:* particleboard with foil finish.

Breathe a personal and fresh look into your kitchen with colourful accent doors. JÄRSTA series comes in a high gloss finish that creates a modern expression and is super easy to wipe clean.

W400×H800 mm 104.699.83

---



### HASSLARP

*Colour/design:* brown/patterned.  
*Material:* clear lacquered oak veneer and solid oak.

The herringbone patterned oak veneer with characteristic details gives your kitchen a unique accent. Designed to match the SINARP series, but can also be paired with solid-coloured doors for a modern look.

W400×H800 mm 904.047.80

---

## Drawer fronts

---

Our drawer front families only comes with drawer fronts and no doors. They are designed to complement the doors in our range and come in a limited amount of sizes.

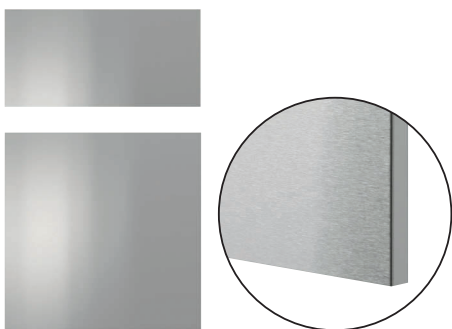

### VÄRSTA

*Colour/design:* stainless steel.  
*Material:* particle board and stainless steel

VÄRSTA fronts made with hardwearing, stainless steel bring an industrial, restaurant feel into your kitchen and will inspire the chef inside of you to whip up many marvellous meals just like a pro.

W40×H40 mm 304.105.95

---



### FRÖJERED

*Colour/design:* light bamboo.  
*Material:* clear lacquered bamboo.

Vibrant and warm with a "wow" feel. FRÖJERED fronts are made of natural bamboo - a sustainable and hard-wearing material that's perfect in the kitchen. Integrated handles enhance the clean, modern look.

W40×H40 mm 304.416.53

---

# METHOD

## cover panels, decorative strips, plinths and legs

---

### Add the finishing touches

Whether you've decided to go for a more traditional style with lots of drawers and decorative elements, or a sleek modern, more minimalistic approach, there are still finishing touches for you to add to make your kitchen stunning.

Enhance your style with uniform cover panels, decorative strips, legs and plinths. Or, you can be a bit bold and go for a finish that contrasts with your doors and drawers. It's all up to you.





Cover panel

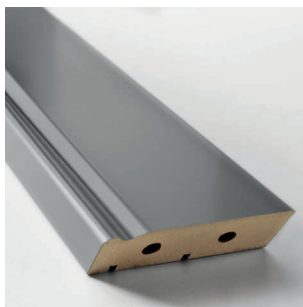

Decorative plinth



Decorative strip



Plinth with cut-out

## Cover panels

Choose a cover panel in the same finish as your door for a uniform expression, or mix and match to suit your taste.

**ASKERSUND cover panel, dark brown ash effect.**

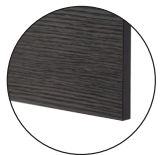

Available sizes, width×height	
39×86 cm	604.252.32
39×106 cm	004.252.30
39×240 cm	804.252.31
<hr/>	
62×80 cm	904.252.35
62×220 cm	404.252.33
62×240 cm	204.252.34

**ASKERSUND cover panel, light ash effect.**



Available sizes, width×height	
39×86 cm	603.318.46
39×106 cm	103.318.44
39×240 cm	803.318.45
<hr/>	
62×80 cm	003.318.49
62×220 cm	403.318.47
62×240 cm	203.318.48

**AXSTAD cover panel, matt blue.**

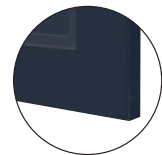

Available sizes, width×height	
39×86 cm	204.752.43
39×106 cm	604.752.41
39×240 cm	404.752.42
<hr/>	
62×80 cm	504.752.46
62×220 cm	004.752.44
62×240 cm	704.752.45

**BODARP cover panel, grey-green.**

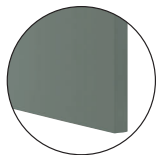

Available sizes, width×height	
39×86 cm	604.355.23
39×106 cm	004.355.21
39×240 cm	804.355.22
<hr/>	
62×80 cm	904.355.26
62×220 cm	404.355.24
62×240 cm	104.355.25

**BODBYN cover panel, grey.**

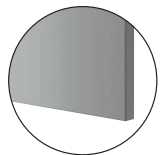

Available sizes, width×height	
39×86 cm	102.344.28
39×106 cm	302.210.62
39×240 cm	902.210.64
<hr/>	
62×80 cm	102.210.63
62×220 cm	102.344.52
62×240 cm	502.210.61

**LERHYTTAN cover panel, light grey.**

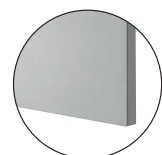

Available sizes, width×height	
39×85 cm	103.523.51
39×105 cm	503.523.49
39×240 cm	303.523.50
<hr/>	
62×80 cm	503.523.54
62×220 cm	903.523.52
62×240 cm	703.523.53

**KALLARP cover panel, high-gloss dark red-brown.**

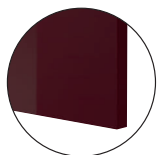

Available sizes, width×height	
39×86 cm	904.282.72
39×106 cm	304.282.70
39×240 cm	104.282.71
<hr/>	
62×80 cm	204.282.75
62×220 cm	704.282.73
62×240 cm	504.282.74

**KUNGSBACKA cover panel, anthracite.**



Available sizes, width×height	
39×83 cm	803.373.24
39×103 cm	203.373.22
39×240 cm	003.373.23
<hr/>	
62×80 cm	103.373.27
62×220 cm	503.373.25
62×240 cm	303.373.26

**FRÖJERED cover panel, light bamboo.**



Available sizes, width×height	
39×80 cm	104.416.25
<hr/>	
62×80 cm	904.416.31

**KALLARP cover panel, high gloss light grey-blue.**



62×80 cm	805.201.34
62×220cm	205.201.32
62×240cm	005.201.33

**New**

**LERHYTTAN cover panel, black stained.**

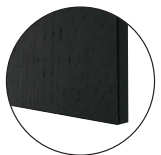

Available sizes, width×height	
39×85 cm	303.560.46
39×105 cm	103.560.85
39×240 cm	503.560.45
<hr/>	
62×80 cm	103.560.90
62×220 cm	103.560.47
62×240 cm	303.560.89

**RINGHULT cover panel, high-gloss light grey.**



Available sizes, width×height

39×86 cm	703.271.27
39×106 cm	103.271.25
39×240 cm	903.271.26

62×80 cm	103.271.30
62×220 cm	503.271.28
62×240 cm	303.271.29

**SINARP cover panel, brown.**



Available sizes, width×height

39×86 cm	004.041.43
39×106 cm	404.041.41
39×240 cm	204.041.42

62×80 cm	304.041.46
62×220 cm	804.041.44
62×240 cm	504.041.45

**STENSUND cover panel, beige.**

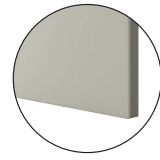

Available sizes, width×height

39×83 cm	104.531.66
39×103 cm	604.531.64
39×240 cm	304.531.65

62×80 cm	504.531.69
62×220 cm	904.531.67
62×240 cm	704.531.68

**STENSUND cover panel, white.**



Available sizes, width×height

39×83 cm	904.505.45
39×103 cm	404.505.43
39×240 cm	204.505.44

62×80 cm	304.505.48
62×220 cm	704.505.46
62×240 cm	504.505.47

**VÅRSTA cover panel with legs, stainless steel.**



Available sizes, width×height

39×80 cm	804.106.06
62×80 cm	304.106.04

**VEDDINGE cover panel, grey.**

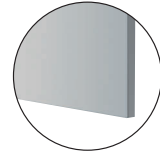

Available sizes, width×height

39×86 cm	002.344.43
39×106 cm	002.209.93
39×240 cm	502.209.95

62×80 cm	802.209.94
62×220 cm	902.344.67
62×240 cm	202.209.92

**VOXTORP cover panel, high-gloss light beige.**



Available sizes, width×height

39×86 cm	803.211.39
39×106 cm	203.211.37
39×240 cm	003.211.38

62×80 cm	003.211.43
62×220 cm	403.211.41
62×240 cm	203.211.42

**VÅRSTA cover panel, stainless steel.**



Available sizes, width×height

39×80 cm	804.105.88
62×80 cm	604.105.89

## FÖRBÄTTRA cover panels

Our FÖRBÄTTRA white and dark grey cover panels are developed to fit all our white and dark grey doors and drawer fronts.

Choose a FÖRBÄTTRA in the same colour and finish as your door for a perfect match.

**FÖRBÄTTRA cover panel, dark grey.**

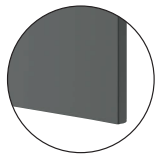

Available sizes, width×height

39×86 cm	304.540.80
39×106 cm	704.540.78
39×240 cm	504.540.79

62×80 cm	704.540.83
62×220 cm	104.540.81
62×240 cm	904.540.82

**FÖRBÄTTRA cover panel, high-gloss white.**



Available sizes, width×height

39×86 cm	303.974.76
39×106 cm	803.974.74
39×220 cm	503.974.75

62×80 cm	703.974.79
62×220 cm	103.974.77
62×240 cm	903.974.78

**FÖRBÄTTRA cover panel, matt white.**

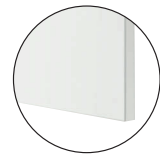

Available sizes, width×height

39×86 cm	604.176.61
39×106 cm	004.176.59
39×240 cm	804.176.60

62×80 cm	004.176.64
62×220 cm	404.176.62
62×240 cm	204.176.63

**FÖRBÄTTRA cover panel, off-white.**



Available sizes, width×height

39×86 cm	402.344.36
39×106 cm	302.057.26
39×240 cm	102.057.27

62×80 cm	902.057.28
62×220 cm	402.344.60
62×240 cm	502.057.25

**FÖRBÄTTRA cover panel, white.**



Available sizes, width×height

39×86 cm	102.978.83
39×106 cm	502.978.81
39×240 cm	302.978.82

62×80 cm	402.978.86
62×220 cm	902.978.84
62×240 cm	602.978.85

## Decorative strips

Decorative strips provides the finishing touch to your kitchen. They come in many different styles, but we have something for all of our door and drawer families. Use them to tie your style together, hide lighting or just as a decorative element.

You can choose how to mount them on your cabinets. Below we show the entire range and some different ways of mounting them both above as mouldings and below your cabinet, either wrapped around the whole cabinet or just between your cover panels.

**ASKERSUND decorative strip rounded,**  
dark brown ash effect.

221×6 cm 704.252.36



**ASKERSUND decorative strip rounded,**  
light ash effect.

221×6 cm 803.318.50



**AXSTAD decorative strip rounded,**  
matt blue.

221×6 cm 304.752.47



**BODARP decorative strip rounded,**  
grey-green.

221×6 cm 704.355.27



**BODBYN decorative strip contoured,**  
grey.

221×6 cm 602.210.65



**BODBYN decorative strip contoured,**  
off-white.

221×6 cm 804.177.59



**KALLARP decorative strip rounded,**  
high-gloss dark red-brown.

221×6 cm 004.282.76

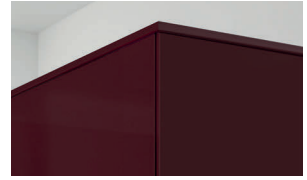

**KUNGSBACKA chamfered decostrip,**  
anthracite.

221×2.8 cm 903.373.28



**LERHYTTAN decorative strip rounded,**  
black stained.

221×4.3 cm 903.560.91



**KALLARP decorative strip,**  
high-gloss light grey-blue.

221×6 cm 505.201.35



## Decorative strips

**LERHYTTAN decorative strip rounded,**  
light grey.

221×4.3 cm      903.523.71

---



**RINGHULT decorative strip rounded,**  
high-gloss light grey.

221×6 cm      903.271.31

---



**SINARP decorative strip rounded,**  
brown.

221×6 cm      104.041.47

---



**STENSUND decorative strip,**  
beige.

221×3 cm      304.531.70

---



**STENSUND decorative strip,**  
white.

221×3 cm      104.505.49

---



**VEDDINGE decorative strip rounded,**  
grey.

221×6 cm      302.209.96

---



**VOXTORP decorative strip rounded,**  
high-gloss light beige.

221×6 cm      803.211.44

---



## FÖRBÄTTRA decorative strips

Our FÖRBÄTTRA white and dark grey decorative strips are developed to fit all our white and dark grey doors and drawer fronts.

Choose a FÖRBÄTTRA in the same colour and finish as your door for a perfect match.

**FÖRBÄTTRA decorative strip rounded,**  
dark grey.

221×6 cm 504.540.84



**FÖRBÄTTRA decorative strip rounded,**  
high-gloss white.

221×6 cm 503.974.80



**FÖRBÄTTRA decorative strip rounded,**  
matt white.

221×6 cm 704.176.65



**FÖRBÄTTRA decorative strip rounded,**  
off-white.

221×6 cm 702.069.60



**FÖRBÄTTRA decorative strip rounded,**  
white.

221×6 cm 202.978.87



## Plinths and legs

Choose between a regular or a decorative plinth to cover the gap between your cabinet and the floor. As an alternative to a plinth you can also choose to put legs on your base and high cabinets.

### BODBYN, grey.



Plinth  
220×8 cm 302.807.73



Decorative plinth  
220×8 cm 502.613.06



Decorative plinth with cut out  
66×8 cm 102.930.74



Leg, 2-pack  
8 cm 102.613.08

### LERHYTTAN black stained.



Plinth  
220×8 cm 403.560.84



Leg for decorative plinth  
103.978.06



Corner leg for decorative plinth.  
2-pack 204.032.27

### LERHYTTAN light grey.



Plinth  
220×8 cm 403.560.84



Leg for decorative plinth  
903.978.07



Corner leg for decorative plinth.  
2-pack 404.032.31

**ASKERSUND** dark brown ash effect.



Plinth  
220×8 cm 404.252.66

**ASKERSUND** light ash effect.



Plinth  
220×8 cm 903.318.78

**AXSTAD** matt blue.



Plinth  
220×8 cm 104.752.48

**BODARP** grey-green.



Plinth  
220×8 cm 204.355.58

**KALLARP** high-gloss dark red-brown.



Plinth  
220×8 cm 704.283.05

**KUNGSBACKA** anthracite.



Plinth  
220×8 cm 703.373.53

**VÅRSTA** stainless steel colour.



Plinth  
220×8 cm 404.351.47

**RINGHULT** high-gloss light grey.



Plinth  
220×8 cm 603.271.56

**SINARP** brown.



Plinth  
220×8 cm 004.041.81

**STENSUND** beige.



Plinth  
220×8 cm 104.532.08

**VOXTORP** high-gloss light beige.



Plinth  
220×8 cm 703.211.68

**VEDDINGE** grey.



Plinth  
220×8 cm 903.123.23

**KALLARP** high-gloss light grey-blue.



Plinth  
220×8 cm 805.201.67

## Plinths and legs

### FÖRBÄTTRA plinths and legs

Our FÖRBÄTTRA white and dark grey plinths and legs are developed to fit all our white and dark grey doors and drawer fronts.

Choose a FÖRBÄTTRA in the same colour and finish as your door for a perfect match.

#### FÖRBÄTTRA off-white.



Plinth  
220×8 cm 602.807.76



Decorative plinth  
220×8 cm 302.613.07



Decorative plinth with cut out  
66×8 cm 402.930.77



Leg, 2-pack.  
8 cm 902.613.09

#### FÖRBÄTTRA dark grey.



Plinth  
220×8 cm 804.541.10

#### FÖRBÄTTRA white.



Plinth  
220×8 cm 403.275.05

#### FÖRBÄTTRA high-gloss white.



Plinth  
220×8 cm 703.975.06

#### FÖRBÄTTRA matt white.



Plinth  
220×8 cm 504.176.66

## Legs



**METHOD leg**, 8 cm, 4-p. May be completed with plinth.

402.055.99



**CAPITA leg**, 8 cm, 4-p.

Stainless steel 302.443.46



**CAPITA leg**, 16 cm, 4-p.

Stainless steel 102.678.95



**UTBY leg**, 8 cm, 2-p.

Stainless steel 902.443.34



**UTBY leg**, stainless steel.

90 cm 801.175.48

105 cm 201.175.51



**FÖRBÄTTRA**  
Decorative plinth.  
220×8 cm, off-white,  
302.613.07

# METOD cabinets

---

## Modular cabinets that fits your space

What does your dream kitchen look like? How much time will you spend in it and how will you use it? When it comes to kitchens, we're all different. We have different dreams, different needs and different preconditions. To meet this diversity, what could be better than a highly flexible kitchen system with

cabinets that can suit everyone, and be planned in everywhere? Whatever the size of your home or family, with cabinets in different sizes, drawers with endless possibilities and interior organisers made to match, you can turn the kitchen of your dreams into the kitchen in your home.

**25**

The METOD kitchen system has a 25-year guarantee.



On this page you can see all available METHOD cabinets and their sizes. Choose and mix them to fit the architecture of your room as well as your own needs.

## METHOD base cabinets



### METHOD frame base cabinet 20×60×80 cm.

White	302.125.62
Wood effect black	002.125.68



### METHOD frame base cabinet 30×37×80 cm.

White	204.171.49
Wood effect black	604.171.85



### METHOD frame base cabinet 30×60×80 cm.

White	504.171.95
Wood effect black	104.172.82



### METHOD frame base cabinet 40×37×80 cm.

White	302.056.32
Wood effect black	802.056.44



### METHOD frame base cabinet 40×60×80 cm.

White	802.134.32
Wood effect black	702.056.30



### METHOD frame base cabinet 60×37×80 cm.

White	502.056.31
Wood effect black	602.056.35



### METHOD frame base cabinet 60×60×80 cm.

White	502.056.26
Wood effect black	902.056.34



### METHOD frame base cabinet 80×37×80 cm.

White	102.056.28
Wood effect black	902.056.29



### METHOD frame base cabinet 80×60×80 cm.

White	102.056.33
Wood effect black	702.056.25

## METHOD base cabinets for built-in

See all our appliances in the Appliance buying guide available on [www.IKEA.co.uk](http://www.IKEA.co.uk)



### METHOD base cabinet for built-in oven/sink 60×60×80 cm.

White	702.135.69
Wood effect black	202.055.43



### METHOD base cabinet for built-in oven/sink 80×60×80 cm.

White	502.154.75
Wood effect black	802.154.74

## METHOD high cabinets



### METHOD frame high cabinet 40×37×200 cm.

White	102.125.63
Wood effect black	202.125.72



### METHOD frame high cabinet 40×60×200 cm.

White	902.125.59
Wood effect black	402.125.71



### METHOD frame high cabinet 40×60×220 cm.

White	102.125.58
Wood effect black	402.125.66



### METHOD frame high cabinet 60×37×200 cm.

White	702.125.60
Wood effect black	602.125.70



### METHOD frame high cabinet 60×60×200 cm.

White	602.125.65
Wood effect black	802.125.69



### METHOD frame high cabinet 60×60×220 cm.

White	902.125.64
Wood effect black	202.125.67



### METHOD frame high cabinet 80×37×200 cm.

White	502.125.61
Wood effect black	002.125.73

## METOD high cabinets for built-in

See all our appliances in the Appliance buying guide available on [www.IKEA.co.uk](http://www.IKEA.co.uk)



**METOD high cabinet frame for fridge/oven 60×60×200 cm.**

White	902.135.68
Wood effect black	702.135.74



**METOD high cabinet frame for fridge/oven 60×60×220 cm.**

White	502.135.70
Wood effect black	202.135.76



**METOD high cabinet frame for fridge/oven 60×60×140 cm.**

White	203.854.74
Wood effect black	103.854.79

## METOD top cabinets

See all our appliances in the Appliance buying guide available on [www.IKEA.co.uk](http://www.IKEA.co.uk)



**METOD top cabinet 40×60×40 cm.**

White	602.240.78
Wood effect black	502.240.74



**METOD fridge/freezer top cabinet frame 60×60×40 cm.**

White	402.055.37
Wood effect black	402.055.56



**METOD fridge/freezer top cabinet frame 60×60×60 cm.**

White	002.055.39
Wood effect black	202.055.24

## METOD corner cabinets



**METOD corner base cabinet frame 128×68×80 cm.**

White	602.055.17
Wood effect black	702.055.12



**METOD corner base cabinet frame 88×88×80 cm.**

White	202.055.19
Wood effect black	402.055.18



**METOD corner wall cabinet frame 68×68×60 cm.**

White	002.125.54
Wood effect black	602.056.59



**METOD corner wall cabinet frame 68×68×80 cm.**

White	202.056.61
Wood effect black	802.056.58



**METOD corner wall cabinet frame 68×68×100 cm.**

White	702.152.81
Wood effect black	902.152.80

## METOD wall cabinets



**METOD frame wall cabinet 20×37×80 cm.**

White	802.521.12
Wood effect black	602.521.13



**METOD frame wall cabinet 30×37×60 cm.**

White	404.210.51
Wood effect black	104.210.57



**METOD frame base cabinet 30×37×80 cm.**

White	704.172.98
Wood effect black	604.173.07



**METOD frame wall cabinet 40×37×40 cm.**

White	102.055.29
Wood effect black	302.055.52



**METOD frame wall cabinet 40×37×60 cm.**

White	102.055.34
Wood effect black	502.055.46



**METOD frame wall cabinet 40×37×100 cm.**

White	502.055.32
Wood effect black	402.055.42



**METOD frame wall cabinet 40×37×80 cm.**

White	702.055.31
Wood effect black	502.055.51



**METOD frame wall cabinet 60×37×40 cm.**

White	302.055.33
Wood effect black	702.055.50



**METOD frame wall cabinet 60×37×60 cm.**

White	802.055.35
Wood effect black	702.055.45



**METOD frame wall cabinet 60×37×80 cm.**

White	302.055.28
Wood effect black	602.055.41



**METOD frame wall cabinet 60×37×100 cm.**

White	202.055.38
Wood effect black	902.055.49



**METOD frame wall cabinet 80×37×40 cm.**

White	802.055.40
Wood effect black	002.055.44



**METOD frame wall cabinet 80×37×60 cm.**

White	602.055.22
Wood effect black	602.055.55



**METOD frame wall cabinet 80×37×80 cm.**

White	702.055.26
Wood effect black	102.055.48



**METOD frame wall cabinet 80×37×100 cm.**

White	902.055.30
Wood effect black	302.055.47

## Open storage

Create a nice break in a row of cabinets with doors using open cabinets. Your kitchen becomes more personal and you can have often used items like cookbooks within arm's reach.



### TORNVIKEN open cabinet.

20×37×40 cm	
Grey	603.589.92
White	203.589.65
20×37×60 cm	
Grey	403.589.93
White	603.589.68
20×37×80 cm	
Grey	203.589.94
White	203.589.70



**TORNVIKEN box**, 16×34×15 cm. A flexible box that you can place in TORNVIKEN open cabinet and also lift out and place somewhere – like on the worktop or the dining table.

Grey	003.589.66
White	003.589.71

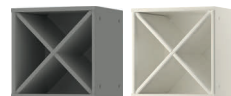

**TORNVIKEN wine shelf**, 40×37×40 cm.

Grey	803.589.67
White	803.589.72



### VADHOLMA open storage, brown/stained ash.

20×37×40 cm	603.743.36
20×37×60 cm	603.743.41
20×37×80 cm	203.743.38



**VADHOLMA drawer unit**, 40×37×40 cm. Smooth-running drawers with stop, self-closing the last centimetres. You can view and access what's inside, as the drawers can be pulled out all the way.

Brown/ stained ash	503.743.32
--------------------	------------



Christine  
SIMPLY SWEDISH  
ITALIAN SPICED  
CLASSIC

PIE  
ROW

PIE  
ROW



# METOD interior fittings and organisers

---

## Hidden helpers

With METOD interior fittings and organisers, you can get the look you want on the outside without revealing what's inside. The cabinets can be hiding all sorts of kitchen surprises. Behind a door you can find pull-out organisers for your cleaning equipment, organisers keeping all your pot lids in perfect order, or a great bunch of fully extendable drawers

making everything easy to reach. Not to mention drawers inside drawers allowing you to utilise the cabinet space to a maximum. It's really up to you what goes inside your kitchen cabinets.

On the following pages you'll find numerous of handy helpers making your daily work in the kitchen run smoother.



## MAXIMERA drawers and drawer accessories

MAXIMERA drawers pull out all the way, and thanks to a built-in damper they always close softly and effortlessly. You have complete overview and you can easily reach the smallest of utensils even at the back of the drawer.

MAXIMERA drawers are available in different sizes to give you plenty of options depending on your storage needs. You can also add inner drawers to fully utilise the cabinet space.



**MAXIMERA pull-out interior fittings.**

20 cm	202.972.79
30 cm	504.170.39



**MAXIMERA drawer low\*, white.**

40×37 cm	502.850.29
40×60 cm	302.850.30
60×37 cm	102.850.31
60×60 cm	902.850.32
80×37 cm	702.850.33
80×60 cm	502.850.34



**MAXIMERA drawer medium\*, white.**

40×37 cm	202.850.35
40×60 cm	002.850.36
60×37 cm	802.850.37
60×60 cm	602.850.38
80×37 cm	402.850.39
80×60 cm	202.850.40



**MAXIMERA drawer high, white.**

40×37 cm	202.850.21
40×60 cm	002.850.22
60×37 cm	802.850.23
60×60 cm	302.850.25
80×37 cm	102.850.26
80×60 cm	702.850.28

**For waste sorting**

60×45 cm	602.850.24
80×45 cm	902.850.27



**MAXIMERA add-on side for high drawer, glass, 2-p.**

37 cm	102.388.60
60 cm	502.388.58



**MAXIMERA add-on side for medium drawer, glass, 2-p.**

37 cm	702.388.62
60 cm	302.388.59



**MAXIMERA divider for high drawer, white/transparent.**

40 cm	802.427.45
60 cm	602.427.46
80 cm	402.427.47



**MAXIMERA divider for medium drawer, white/transparent.**

40 cm	302.046.75
60 cm	602.046.74
80 cm	702.046.78



**UTRUSTA wire basket.**

40 cm	802.046.73
60 cm	002.046.72



**UTRUSTA drawer front, low, white.**

40 cm	802.214.51
60 cm	402.046.51
80 cm	202.046.52



**UTRUSTA drawer front, medium, white.**

40 cm	602.214.52
60 cm	802.046.54
80 cm	402.214.53



**UTRUSTA drawer front, high, white.**

40 cm	002.046.53
60 cm	502.046.55
80 cm	302.046.56

## EXCEPTIONELL drawers

EXCEPTIONELL drawer is a smooth-running, push-to-open, full-extension drawer with built-in dampers so that it closes slowly, softly and quietly. You can create more storage with inner drawers, either inside a higher drawer or behind the door. You can use the top drawer

for cutlery and utensils and the other drawers for pots and pans. Makes it easier to keep your cutlery and utensils organised, so you can quickly find what you need in the kitchen drawer and start cooking.



**EXCEPTIONELL pull-out interior fittings, with push to open.**

20 cm	104.478.25
30 cm	904.478.26



**EXCEPTIONELL drawer, low with push to open, white.**

40×37 cm	904.478.12
40×60 cm	504.478.14
60×37 cm	204.478.15
60×60 cm	004.478.16
80×37 cm	804.478.17
80×60 cm	604.478.18



**EXCEPTIONELL drawer, medium with push to open, white.**

40×37 cm	404.478.19
40×60 cm	204.478.20
60×37 cm	004.478.21
60×60 cm	804.478.22
80×37 cm	604.478.23
80×60 cm	404.478.24



**EXCEPTIONELL drawer, high with push to open, white.**

40×37 cm	604.478.04
40×60 cm	304.478.05
60×37 cm	104.478.06
60×45 cm	904.478.07
60×60 cm	704.478.08
80×37 cm	504.478.09
80×45 cm	304.478.10
80×60 cm	104.478.11

## Corner interior



**UTRUSTA wall corner cabinet carousel.**

802.656.47



**UTRUSTA corner base cabinet pull-out fitting.**

128 cm 402.152.92



**UTRUSTA corner base cabinet carousel.**

88 cm 602.152.91

## METHOD system fittings and hinges

Even the smaller details are important when you are planning a complete kitchen. It all depends on your needs and wishes – but maybe it's just this small part that will make a big difference.



**METHOD suspension rail, 200 cm.**  
Galvanised 602.056.64



**METHOD ventilation grille.**  
Stainless steel 702.561.77



**METHOD ventilated plinth, 60 cm.**  
Stainless steel 302.214.58



**UTRUSTA push opener, electrical.** You can open the waste sorting bin with the push of a finger – or your hip, knee or foot if your hands are busy.  
302.386.99



**UTRUSTA push opener, 2-p.** Push to open; no handles needed.  
802.302.24



**UTRUSTA hinge 45°, 2-p.** The hinge is only for use with a corner wall cabinet and is only needed when you want to mount two doors on the cabinet.  
202.619.92



**UTRUSTA hinge 95°, 2-p.** Fits cabinets for integrated fridge/freezers.  
202.046.47



**UTRUSTA hinge with built-in damper 110°, 2-p.** This hinge has an integrated damper, so that the door closes slowly, softly and silently. You can easily deactivate the damper with a slide button, for example if you want to use a push opener or if the door closes too slowly, and re-activate it if you want.  
805.248.82



**UTRUSTA hinge with built-in damper for kitchen 153°, 2-p.** This hinge has an integrated damper, so that the door closes slowly, softly and silently. You can easily deactivate the damper with a side button, for example if you want to use a push opener or if the door closes too slow, and re-activate it if you want.  
104.272.62



**UTRUSTA hinge with push-opener for horizontal door, 2-p.** Push to open; no handles needed. Door lift with catch for gentle closing included. You can easily mount the door front in the right position, because the hinges are adjustable in height, depth and width. Snap-on hinges can be mounted onto the door without screws, and you can easily remove the door for cleaning.  
Black 904.624.83  
White 704.624.84



**UTRUSTA hinge with damper for horizontal door, 2-p.** This hinge has an integrated damper, so that the door closes slowly, softly and silently. You can easily mount the door front in the right position, because the hinges are adjustable in height, depth and width. Snap-on hinges can be mounted onto the door without screws, and you can easily remove the door for cleaning.  
Black 704.624.79  
White 504.624.80

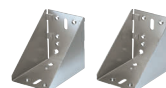

**UTRUSTA corner fittings, 2-p.** By using the corner fitting, you can build a corner wall-cabinet solution at a 90° angle.  
Galvanised 403.059.71



**METHOD support bracket for kitchen island.** The assembly set makes it easy for you to mount cabinets back to back, or to attach a cover panel to the back of the base cabinets.  
40 cm 202.984.05



**METHOD assembly kit for kitchen island.** The assembly set makes it easy for you to mount cabinets back to back, or to attach a cover panel to the back of the base cabinets.  
202.984.10

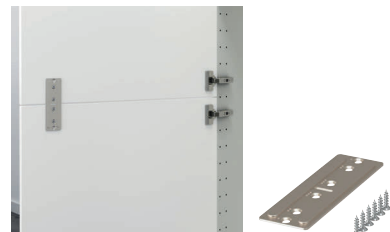

**UTRUSTA connection fitting for doors.** UTRUSTA connection fitting for doors is used to connect two doors to one, so you get a uniform look for e.g. a high cabinet or an integrated fridge and freezer.  
303.669.17



**METOD support bracket for kitchen island.** The assembly set makes it easy for you to mount cabinets back to back, or to attach a cover panel to the back of the base cabinets.

40 cm 202.984.05



**UTRUSTA connecting rail for fronts.** You can easily align the drawer front with the other doors and drawer fronts in your kitchen and create a smooth, streamlined look with the help of UTRUSTA connection rail.

303.122.36

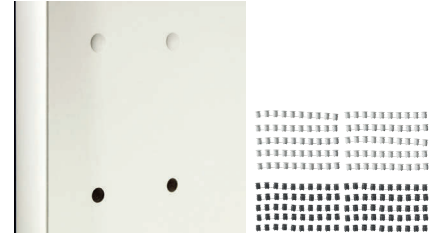

**VARIERA cover cap, 100-p.** Covers drill holes in the glass door cabinet or open shelf. Suitable for all products with 5 mm holes.

White 002.263.15  
Black 802.263.16



**UTRUSTA fitting for mounting drawer on door.**

103.122.37



**UTRUSTA assembly kit for pull-out function.**

105.153.29

## Shelves



**UTRUSTA shelf\*, white, 2-p.**

20×60 cm	702.056.06
30×37 cm	304.173.42
30×60 cm	304.173.99
40×37 cm	402.056.22
40×60 cm	302.056.13
60×37 cm	102.056.14
60×60 cm	502.056.12
80×37 cm	102.056.09
80×60 cm	702.056.11



**UTRUSTA shelf\*, wood effect black, 2-p.**

20×60 cm	802.056.15
30×37 cm	504.173.98
30×60 cm	004.174.09
40×37 cm	502.129.76
40×60 cm	602.056.21
60×37 cm	802.056.20
60×60 cm	002.056.19
80×37 cm	202.056.18
80×60 cm	402.056.17



**UTRUSTA shelf\*, glass, 2-p.**

30×37 cm	204.174.13
40×37 cm	202.133.31
60×37 cm	902.056.05
80×37 cm	202.056.04



**UTRUSTA shelf for corner wall cabinet\*, 68 cm.**

Glass	802.056.63
White	002.056.62
Wood effect black	402.056.60



**UTRUSTA shelf for corner base cabinet\*, 128 cm.**

White	502.132.97
Wood effect black	302.132.98



**UTRUSTA shelf for corner base cabinet\*, 88 cm.**

White	802.776.50
Wood effect black	602.776.51



**UTRUSTA fixed ventilated shelf\*, 60×60 cm.**

White	902.135.73
Wood effect black	102.135.72

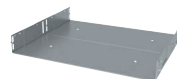

**UTRUSTA bracket for oven\*.**

Galvanised	103.019.60
------------	------------

## Additional interior fittings and organisers



**UTRUSTA towel rail**, 16 cm. It's easy to access towels because it pulls out.  
 White 502.472.16



**VARIERA pot lid organiser**, stainless steel. You can customise the length based on your storage needs.  
 701.548.00



**VARIERA holder for iron**. Keep things tidy with help from the included iron cord holder.  
 Galvanised 900.903.84



**UTRUSTA cleaning interior**, 140 cm. Pull-out organisers make it easy for you to see and reach your cleaning supplies.  
 403.258.89



**UTRUSTA dish drainer for wall cabinet**. Can be mounted in a wall cabinet to free up space on the worktop.  
 40x35 cm 902.046.15  
 60x35 cm 202.046.14  
 80x35 cm 002.153.12



**UTRUSTA pull-out work surface**, 60 cm. You can never have too much work space in the kitchen. This clever pull-out surface comes to the rescue when unloading groceries or chopping veggies and hides away when you push it in again.  
 005.105.77



**VARIERA plastic bag dispenser**. Ideal for storing things like plastic bags, toilet/kitchen rolls, gloves and socks.  
 White 800.102.22



**VARIERA pull-out container**. It's easy to access what's inside because it pulls out.  
 White 402.417.95



**VARIERA shelf insert**, white. Place on a shelf to get more storage space for glasses, bowls and spice jars. Makes the contents of the cabinet easy to overview and access.  
 32x13x16 cm 801.366.22  
 32x28x16 cm 601.366.23



**UPPDATERA plate holder**, anthracite. The plate holder is adjustable, so you can customise the width based on the size of your plates.  
 15-23 cm 704.861.78  
 18-31 cm 504.861.79



**UTRUSTA pull-out work surface**, 60 cm. You can never have too much work space in the kitchen. This clever pull-out surface comes to the rescue when unloading groceries or chopping veggies and hides away when you push it in again.  
 005.105.77



**VARIERA plastic bag dispenser**. Ideal for storing things like plastic bags, toilet/kitchen rolls, gloves and socks.  
 White 800.102.22 €000

**UPPDATERA**  
Pegboard drawer organiser.  
60 cm. 604.600.08



# ENHET kitchen system

---

## Plan less, live more

ENHET is easy to buy and equally easy to update if you need to, or simply feel like it. You can choose between ready-made combinations online and buy your favourite with a few clicks. All parts are easy to assemble, intuitively and without any special tools.

The playful design in different colours inspires you to adapt ENHET to reflect your personality. With a combination of closed cabinets and open shelves in stable metal frames you can display your favourite things and hide the rest. The ENHET kitchen units also come in different widths and depths, making them easy to adapt to a smaller space.

Helping you keep your kitchen utensils neatly organised and close at hand, the ENHET accessories include a hook rail that can be moved around without having to drill into the wall, a swivel tray for smaller items and a shelf insert that you simply hang in the grooves of an open frame to maximise storage space – no tools needed.

**10**

The ENHET kitchen and kitchen mixer taps have a 10-year guarantee.





# ENHET complete kitchens

Getting a complete kitchen has probably never been easier. We have combined ENHET units into a number of practical solutions that you can find online and buy directly, so all you have to do is find the kitchen that fits your needs and matches your temperament. By combining open and

closed storage, different colours and adding the accessories you want, you can have a fully functional and personalised kitchen up and running in no time.



ENHET K100



ENHET K101



ENHET K102



ENHET K103



ENHET K104



ENHET K105



ENHET K106



ENHET K107



ENHET K108



ENHET K109



ENHET K110



ENHET K111



ENHET K112



ENHET K113



ENHET K114



ENHET K115



ENHET K116



ENHET K117



ENHET K118



ENHET K119



ENHET K120



ENHET K121



ENHET K122



ENHET K123



ENHET K500



ENHET K501



ENHET K502



ENHET K503



ENHET K504



ENHET K505



ENHET K506



ENHET K507



ENHET K508

# ENHET complete kitchens

Pick, click, buy and assemble – you are just a few steps away from cooking and hanging out in your kitchen. It's time to get into details and find a solution that offers the size, storage possibilities, colour(s) and accessories that you prefer. In the

following you can find the information about the different combinations that you need to make your final decision. The hardest thing now will be to choose your absolute favourite.



### ENHET K100 W103×D63.5×H222 cm.

This combination is only 103 cm wide but offers a perfect mix of open and closed storage and all the functions you need.

This combination with	White frame	Anthracite frame
White basic door	—	293.367.14
Grey frame door	—	493.367.32
High gloss white door	093.367.05	—
Oak effect door	493.367.08	—
Concrete effect door	—	493.368.93

**Note!** Appliances and lighting products not included.



### ENHET K101 W103×D63.5×H222 cm.

This combination offers a perfect mix of open and closed storage and all the functions you need in a 103 cm space.

This combination with	White frame	Anthracite frame
White basic door	193.368.99	293.369.31
Grey frame door	193.369.03	393.369.78
High gloss white door	493.369.11	—
Oak effect door	293.369.12	—
Concrete effect door	993.369.23	593.370.19

**Note!** Appliances and lighting products not included.



### ENHET K102 W 123×D63.5×H222 cm.

This one offers a mix of open and closed storage, a workspace and room for built-in appliances – all in a 123 cm space.

This combination with	White frame	Anthracite frame
White door	093.370.45	893.370.70
White frame door	—	093.370.74
Grey frame door	293.370.49	—
High gloss white door	693.370.52	—
Oak effect door	993.370.60	—
Concrete effect door	—	693.370.85

**Note!** Appliances and lighting products not included.



### ENHET K103 W123×D63.5×H222 cm.

This combination offers a perfect mix of open and closed storage as well as a combined work and cook area – all in a 123 cm space.

This combination with	White frame	Anthracite frame
White door	193.370.97	793.371.22
White frame door	—	693.371.32
Grey frame door	593.376.46	693.371.46
High gloss white door	993.370.98	—
Oak effect door	493.371.09	—
Concrete effect door	193.371.15	693.371.70

**Note!** Appliances and lighting products not included.



**ENHET K104 W123×D63.5×H222 cm.**

This one offers a perfect mix of open and closed storage and the functions you need in a small but well-planned space.

This combination with	White frame	Anthracite frame
White door	093.371.73	893.372.25
White frame door	—	293.372.28
Grey frame door	393.371.76	693.372.31
High gloss white door	993.371.83	—
Oak effect door	193.372.19	—
Concrete effect door	—	093.372.34

**Note!** Appliances and lighting products not included.



**ENHET K105 W143×D63.5×H222 cm.**

This combination is only 143 cm wide but offers a perfect mix of open and closed storage and all the functions you need.

This combination with	White frame	Anthracite frame
White door	393.372.37	293.372.52
White frame door	—	593.372.55
Grey frame door	793.372.40	993.372.58
High gloss white door	193.372.43	—
Oak effect door	993.372.44	—
Concrete effect door	893.372.49	393.372.61

**Note!** Appliances and lighting products not included.



**ENHET K106 W163×D63.5×H222 cm.**

This combination is a perfect mix of open and closed storage – and gives you space for freestanding appliances.

This combination with	White frame	Anthracite frame
White door	093.372.67	593.372.84
White frame door	—	893.372.87
Grey frame door	493.372.70	293.372.90
High gloss white door	393.372.75	—
Oak effect door	793.372.78	—
Concrete effect door	193.372.81	—

**Note!** Appliances and lighting products not included.



**ENHET K107 W163×D63.5×H222 cm.**

This one offers a perfect mix of open and closed storage as well as a combined cook and work area in a small but well-planned space.

This combination with	White frame	Anthracite frame
White door	093.373.09	193.373.56
White frame door	—	—
Grey frame door	193.373.23	493.373.69
High gloss white door	493.373.31	—
Oak effect door	593.373.40	—
Concrete effect door	493.373.45	193.373.75

**Note!** Appliances and lighting products not included.



**ENHET K108 W163×D63.5×H222 cm.**

This one offers a perfect mix of open and closed storage, room for built-in appliances and ample workspace if you choose a narrow hob.

This combination with	White frame	Anthracite frame
White basic door	993.373.81	193.374.36
White frame door	—	—
Grey frame door	393.373.84	693.374.48
High gloss white door	793.374.24	—
Oak effect door	093.374.27	—
Concrete effect door	293.374.31	393.374.59

**Note!** Appliances and lighting products not included.



**ENHET K109 W183×D63.5×H222 cm.**

This one offers a perfect mix of open and closed storage as well as a combined cook and work area in a small but well-planned space.

This combination with	White frame	Anthracite frame
White basic door	293.374.69	493.375.19
White frame door	—	—
Grey frame door	393.374.78	993.375.31
High gloss white door	093.374.89	—
Oak effect door	493.374.92	193.375.49
Concrete effect door	393.375.05	093.375.40

**Note!** Appliances and lighting products not included.



**ENHET K110 W183×D63.5×H222 cm.**

This one offers a perfect mix of open and closed storage, a combined cook and work area, and smart use of space for appliances.

This combination with	White frame	Anthracite frame
White basic door	493.373.07	593.373.59
White frame door	—	—
Grey frame door	493.373.26	693.373.73
High gloss white door	293.373.32	—
Oak effect door	193.373.37	—
Concrete effect door	993.373.43	593.373.78

**Note!** Appliances and lighting products not included.



**ENHET K111 W183×D63.5×H222 cm.**

Here you have open and closed storage, space for a freestanding appliance and ample space to prepare food or fold laundry.

This combination with	White frame	Anthracite frame
White basic door	493.373.88	793.374.57
White frame door	—	793.374.62
Grey frame door	793.374.43	693.374.67
High gloss white door	293.374.45	—
Oak effect door	893.374.52	—
Concrete effect door	193.374.55	593.374.63

**Note!** Appliances and lighting products not included.



**ENHET K112 W183×D63.5×H222 cm.**

In this well-planned space you have open and closed storage, a work area and space for freestanding and built-in appliances.

This combination with	White frame	Anthracite frame
White basic door	593.374.77	993.375.07
White frame door	—	393.375.10
Grey frame door	593.374.82	593.375.14
High gloss white door	493.374.87	—
Oak effect door	593.374.96	—
Concrete effect door	093.375.02	893.375.17

**Note!** Appliances and lighting products not included.



**ENHET K113 W183×D63.5×H222 cm.**

This one offers closed storage to hide the clutter, open storage to show your finest tableware and a combined work and cook area.

This combination with	White frame	Anthracite frame
White basic door	693.374.34	393.375.29
White frame door	—	—
Grey frame door	893.374.85	893.375.36
High gloss white door	993.374.18	—
Oak effect door	893.375.22	—
Concrete effect door	793.375.27	493.375.38

**Note!** Appliances and lighting products not included.



**ENHET K114 W203×D63.5×H222 cm.**

This one offers a perfect mix of open and closed storage, room for built-in appliances and ample workspace if you choose a narrow hob.

This combination with	White frame	Anthracite frame
White basic door	193.375.54	393.374.02
White frame door	—	—
Grey frame door	693.375.56	193.375.68
High gloss white door	493.375.62	—
Oak effect door	893.375.60	—
Concrete effect door	493.375.62	793.375.70

**Note!** Appliances and lighting products not included.



**ENHET K115 W203×D63.5×H222 cm.**

This kitchen is designed for integrated/built-in appliances in smaller dimensions. With a narrow hob you get a larger work surface – perfect for smaller living spaces.

This combination with	White frame	Anthracite frame
White basic door	593.373.21	093.373.90
White frame door	—	—
Grey frame door	893.373.29	993.373.95
High gloss white door	093.373.47	—
Oak effect door	793.373.63	—
Concrete effect door	793.373.15	593.373.97

**Note!** Appliances and lighting products not included.



**ENHET K116 W223×D63.5×H222 cm.**

A mix of open and closed storage, a work area and space for built-in appliances make this a perfect combination for the everyday chef.

This combination with	White frame	Anthracite frame
White door	493.377.36	393.377.51
White frame door	—	793.377.54
Grey frame door	893.377.39	093.377.57
High gloss white door	293.377.42	—
Oak effect door	593.377.45	—
Concrete effect door	993.377.48	493.377.60

**Note!** Appliances and lighting products not included.



**ENHET K117 W223×D63.5×H222 cm.**

This combination is a perfect mix of open and closed storage – and offers clever use of space for freestanding appliances.

This combination with	White frame	Anthracite frame
White basic door	893.377.63	793.378.48
White frame door	—	—
Grey frame door	693.378.20	393.378.45
High gloss white door	593.378.25	—
Oak effect door	493.378.35	—
Concrete effect door	493.378.40	593.378.73

**Note!** Appliances and lighting products not included.



**ENHET K118 W243×D63.5×H222 cm**

This one is perfect when you prefer to hide the clutter and appliances behind cabinet doors and drawers, for a smooth, uniform look. (No open frame included in this combination.)

This combination with	White frame	Anthracite frame
White basic door	593.378.87	—
White frame door	—	—
Grey frame door	993.378.90	—
High gloss white door	493.379.15	—
Oak effect door	693.379.24	—
Concrete effect door	393.379.30	—

**Note!** Appliances and lighting products not included.



**ENHET K119 W243×D63.5×H241 cm.**

This combination has all the functions the everyday chef needs topped with a strong personal expression with plenty of open storage.

This combination with	White frame	Anthracite frame
White door	903.379.41	493.380.57
White frame door	—	—
Grey frame door	693.379.62	693.380.61
High gloss white door	493.379.77	—
Oak effect door	393.379.87	—
Concrete effect door	393.380.48	993.380.74

**Note!** Appliances and lighting products not included.



**ENHET K120 W243×D63.5×H222 cm.**

Here you have a perfect mix of open and closed storage and generous space for preparing food in a well-planned combination.

This combination with	White frame	Anthracite frame
White basic door	293.380.77	493.381.18
White frame door	—	—
Grey frame door	293.380.82	493.381.23
High gloss white door	993.380.88	—
Oak effect door	893.380.98	—
Concrete effect door	193.381.05	293.381.24

**Note!** Appliances and lighting products not included.



**ENHET K121 W243×D63.5×H241 cm.**

This one offers a cosy breakfast nook and a strong personal expression with shelving and open space for a wall-mounted extractor hood.

This combination with	White frame	Anthracite frame
White basic door	793.381.50	193.382.09
White frame door	—	—
Grey frame door	693.381.60	293.382.18
High gloss white door	993.381.68	—
Oak effect door	693.381.79	393.382.51
Concrete effect door	193.381.86	593.382.31

**Note!** Appliances and lighting products not included.



**ENHET K122 W243×D63.5×H222 cm.**

This one offers a perfect mix of open and closed storage, and ample worktop space for preparing food or folding laundry.

This combination with	White frame	Anthracite frame
White basic door	993.377.91	593.377.93
White frame door	—	—
Grey frame door	893.377.96	993.378.28
High gloss white door	293.377.99	—
Oak effect door	393.378.07	—
Concrete effect door	—	193.378.32

**Note!** Appliances and lighting products not included.



**ENHET K123 W323×D63.5×H241 cm.**

This one offers a personal mix of open and closed storage, a spacious work area and all the functions an aspiring chef needs.

This combination with	White frame	Anthracite frame
White basic door	993.378.47	393.378.93
White frame door	—	493.379.01
Grey frame door	193.378.51	793.379.09
High gloss white door	893.378.57	—
Oak effect/White basic door	093.378.75	—
Concrete effect door	493.378.83	993.379.13

**Note!** Appliances and lighting products not included.



**ENHET K500 W170.5×/168.5×D63.5×H222 cm.**

This one offers a mix of open and closed storage in a corner solution that eases the work flow by putting everything close at hand.

This combination with	White frame	Anthracite frame
White basic door	093.379.36	993.379.70
White frame door	—	193.379.74
Grey frame door	693.379.43	693.379.81
High gloss white door	793.379.52	—
Oak effect door	293.379.59	—
Concrete effect door	293.379.64	993.379.89

**Note!** Appliances and lighting products not included.



**ENHET K501 W181.5/121.5×D63.5×H222 cm.**

This one offers plenty of spacious storage in an open corner and flexibility to stow away the hob to make space for other activities.

This combination with	White frame	Anthracite frame
White basic door	293.381.38	393.381.66
White frame door	—	193.381.72
Grey frame door	693.381.41	993.381.73
High gloss white door	793.381.45	—
Oak effect door	193.381.48	—
Concrete effect door	493.381.56	093.381.82

**Note!** Appliances and lighting products not included.



**ENHET K502 W121.5/185×D63.5×H222 cm.**

This combination offers a perfect mix of open and closed storage and a kitchen island for cooking, working, snacking or socialising.

This combination with	White frame	Anthracite frame
White basic door	193.381.91	893.382.20
White frame door	—	793.382.25
Grey frame door	993.381.92	193.382.28
High gloss white door	293.382.04	—
Oak effect door	793.382.11	—
Concrete effect door	193.382.14	593.382.45

**Note!** Appliances and lighting products not included.



**ENHET K503 W210.5/248.5×D63.5×H226 cm.**

This one offers space for built-in appliances and a corner solution that eases the work flow by putting everything close at hand.

This combination with	White frame	Anthracite frame
White basic door	393.381.52	693.381.98
White frame door	—	593.382.07
Grey frame door	093.381.58	693.382.16
High gloss white door	893.381.64	—
Oak effect/White door	493.381.75	—
Concrete effect/White door	593.381.89	293.382.23

**Note!** Appliances and lighting products not included.



**ENHET K504 W181.5/245×D63.5×H241 cm.**

This combination offers a perfect mix of open and closed storage and a kitchen island that inspires interaction while cooking.

This combination with	White frame	Anthracite frame
White basic door	693.382.78	693.382.35
White frame door	—	493.382.36
Grey frame door	693.382.83	393.382.94
High gloss white door	293.383.03	—
Oak effect door	793.383.05	—
Concrete effect door	693.383.01	793.382.92

**Note!** Appliances and lighting products not included.



**ENHET K505 W181.5/281.5×D63.5×H241 cm.**

Here you have a cosy breakfast nook and a strong personal expression with open shelving - for the chef who loves being in the kitchen.

This combination with	White frame	Anthracite frame
White basic door	693.380.80	593.381.08
White frame door	—	—
Grey frame door	593.380.85	993.381.11
High gloss white door	793.380.09	—
Oak effect door	993.380.93	—
Concrete effect door	293.380.96	893.381.16

**Note!** Appliances and lighting products not included.



**ENHET K506 W261.5/221.5×D63.5×H222 cm.**

This one offers all the functions you need and a generous workspace where you can prepare food or fold clothes.

This combination with	White frame	Anthracite frame
White basic door	393.380.29	293.380.39
White frame door	—	—
Grey frame door	993.380.31	493.380.43
High gloss white door	593.380.33	—
Oak effect door	093.380.35	—
Concrete effect door	693.380.37	993.380.45

**Note!** Appliances and lighting products not included.



**ENHET K507 W190.5/228.5×D63.5×H222 cm.**

This small-size combination offers all the functions the everyday chef needs, including well-planned space for appliances.

This combination with	White frame	Anthracite frame
White basic door	893.380.03	193.380.11
White frame door	—	793.380.13
Grey frame door	293.380.15	393.380.05
High gloss white door	993.380.07	—
Oak effect door	893.381.21	—
Concrete effect/White door	593.380.09	693.380.18

**Note!** Appliances and lighting products not included.



**ENHET K508 W168.5/290.5×D63.5×H241 cm.**

This one offers wall storage in different depths to cater to your needs - a personal expression that puts everything close at hand.

This combination with	White frame	Anthracite frame
White basic door	893.378.43	693.379.76
White frame door	—	—
Grey frame door	193.379.26	093.379.84
High gloss white door	993.379.32	—
Oak effect/White door	993.379.46	—
Concrete effect/White door	693.379.57	593.379.91

**Note!** Appliances and lighting products not included.

# ENHET storage combinations

ENHET is all about simplicity and the possibility to change and adapt your home when your life changes. No matter what happens, everyday life becomes much easier when all things can be found in their designated place, especially if floorspace

is limited. That is why we have developed these combinations that can create extra work and/or storage space. Pick the one that best suits your needs and helps you use your space efficiently.



## ENHET A100 wall storage combination W60×D32×H255 cm.

This combination is a perfect mix of open and closed storage – it hides the clutter and puts the things you love on display. The high cabinet provides ample storage for food, towels and detergents without taking up too much floor space. Perfect for making the best use of wall space in smaller spaces. The open wall frame with 2 shelves gives a good overview and easy access to jars, bottles and things often used.

This combination with	White frame	Anthracite frame
White basic door	293.314.05	293.314.53
White frame door	—	993.314.16
Grey frame door	893.314.07	793.314.17
High gloss white door	693.314.08	—
Oak effect door	093.314.11	—
Concrete effect door	893.314.12	593.314.18



## ENHET A101 wall storage combination W120×D32×H150 cm.

This combination offers just the place for a waste bin and/or towels. The wall cabinet provides ample storage for food, towels and detergents. The open wall frame gives a good overview and easy access to jars, bottles and things often used. The space under the open frame is a smart spot to hang towels, place a freestanding waste bin or why not use it to park your trolley? This combination also includes ENHET swivel shelf which gives you quick and easy access to smaller items like keys, accessories, vitamins or spice jars.

This combination with	White frame	Anthracite frame
White door	093.314.54	793.314.55
White frame door	—	293.314.48
Grey frame door	793.314.36	893.314.50
High gloss white door	593.314.42	—
Oak effect door	193.314.44	—
Concrete effect door	893.314.45	693.314.51



**ENHET A102 wall storage combination**  
**W60×D32×H150 cm.**

This combination offers just the place for waste bins or a washing machine. The open wall frame makes good use of the space under the cabinet. It gives a good overview and easy access to jars, bottles and things often used. The space under the open frame is a smart spot to hang towels, place a freestanding waste bin or why not use it to park your trolley? This combination can also serve as a laundry station with storage for detergents and space under the open frame for your washing machine. This combination also includes ENHET swivel shelf which gives you quick and easy access to smaller items like your spice jars.

This combination with	White frame	Anthracite frame
White basic door	293.314.34	693.314.65
White frame door	—	493.314.66
Grey frame door	593.314.56	093.314.68
High gloss white door	193.314.58	—
Oak effect door	593.314.61	—
Concrete effect door	193.314.63	893.314.69



**ENHET A103 wall storage combination**  
**W121.5×D63.5×H222 cm.**

This combination offers just the place for your freestanding fridge. The cabinet has 3 handy drawers for the smallest utensils to the largest pots. The space next to the cabinet is perfect for a freestanding fridge or freezer. Combine with TILLREDA microwave or portable induction hob for a functional mini kitchen solution. Sold separately. The space next to the cabinet can also be used for a dishwasher or even a washing machine if you are looking to create a laundry station with handy storage for detergents nearby. ENHET hooks put kitchen utensils close at hand. They slide into the grooves under the open ENHET frames. ENHET containers save drawer space and give easy access to things like utensils and herbs. This combination also includes ENHET hanging shelf insert which helps create more storage space between the shelves in the open ENHET frames. Perfect for organising things like espresso cups or jars.

This combination with	White frame	Anthracite frame
White basic door	693.314.70	793.315.11
White frame door	—	593.315.12
Grey frame door	293.314.86	393.315.13
High gloss white door	093.315.00	—
Oak effect door	593.315.07	—
Concrete effect door	993.315.10	193.315.14



**ENHET A104 kitchen island shelf unit**  
**W123×D63.5×H91 cm.**

This kitchen island will be the centre of attention whether you are preparing food, unloading groceries or serving tapas. This combination offers generous open storage for larger things like pots, pans and bread baskets. You can also use it to prepare or serve food, or to place a big bowl of fruit.

This combination with	White frame	Anthracite frame
	693.315.16	493.315.17



**ENHET A105 storage combination for oven/hob**  
**W143×D63.5×H91 cm.**

This combination offers 2 workspaces, plenty of open storage and a handy drawer under the oven for pans, foil and baking paper. Store pots, pans and bowls for preparing the food on one side and place everything for setting the table on the other. The wall-mounted extractor hood makes a big impact – both on the air quality and on the overall expression of your room. Sold separately.

This combination with	White frame	Anthracite frame
	293.315.18	093.315.19



**ENHET A107 wall storage combination  
W123×D63.5×H207 cm.**

Here you have both open and closed storage along with a worktop that's big enough for both a portable hob and a coffee machine. The wall cabinet with doors makes good use of the space above the worktop. Perfect for placing glassware and tableware, keeping them free from dust. The open base frames offer plenty of shelf space for bowls and smaller appliances like toaster, mixer and rice cooker. The space next to the open base frames is perfect for a freestanding fridge or freezer. Combine with a microwave oven or portable induction hob to create a solution for cooking. Sold separately. The space next to the cabinet can also be used for a dishwasher or even a washing machine if you are looking to create a laundry station with handy storage nearby for detergents. This combination also includes SKATTÅN containers which save drawer space and give easy access to things like cutlery and herbs.

This combination with	White frame	Anthracite frame
White door	893.315.58	893.315.63
White frame door	—	393.315.65
Grey frame door	693.315.59	193.315.66
High gloss white door	493.315.60	—
Oak effect door	293.315.61	—
Concrete effect door	093.315.62	793.315.68



**ENHET A108 kitchen island storage combination with seating  
W123×D63.5×H91 cm.**

This kitchen island puts things within easy reach and will soon become your favourite spot for snacking, working and socialising. This kitchen island offers plenty of open storage for things like bowls and trays. There's a space where you can sit for a bite to eat or why not use it as a tapas bar when friends are over for dinner? You can easily add ENHET accessories to extend the use of your storage combination.

This combination with	White frame	Anthracite frame
	593.315.69	993.315.72



**ENHET A109 storage combination for freestanding appliances  
W121.5×D63.5×H222 cm.**

The open storage creates an airy feel and the accessories put things within easy reach – there's even a perfect spot for your fridge. The open wall frame makes good use of the space above the worktop. Perfect for hanging utensils or storing coffee cups, bottles or jars you often use. The open base frame keeps things like serving plates and tableware close at hand. The space next to the open base frame is perfect for a freestanding fridge or freezer. Combine with a microwave oven or portable induction hob to create a solution for cooking. Sold separately. The space next to the cabinet can also be used for a dishwasher or even a washing machine if you are looking to create a laundry station with handy storage nearby for detergents. This combination also includes SKATTÅN containers which save drawer space and give easy access to things like cutlery and herbs.

This combination with	White frame	Anthracite frame
	793.315.73	593.315.74

**ENHET A110 wall/floor storage combination  
W60×D30 cm.**

This combination adds that extra storage space you've longed for, putting everything within arm's reach. The open frames put everything close at hand and easy to overview. The top surface of the base frame is a perfect place for things like a coffee machine or accessories. ENHET swivel shelf gives you quick and easy access to smaller items like keys, accessories, vitamins or spice jars. It fastens easily to any of the open frames in the ENHET series. This combination also includes ENHET hanging shelf insert which helps create more storage space between the shelves in the open frames.

This combination with	white frame	Anthracite frame
	093.315.76	893.315.77



**ENHET A111 wall storage combination  
W40×D30 cm.**

Even in small spaces, you can benefit from closed storage that hides the clutter and open storage that displays things you love. The wall cabinet hides the clutter and keeps things free from dust. The open wall frame makes good use of the space under the cabinet. It gives a good overview and easy access to jars, bottles and things often used. ENHET hanging shelf insert lets you organise your things and create space for more in the open ENHET frames.

This combination with	White frame	Anthracite frame
White basic door	993.355.94	893.355.99
White frame door	—	493.356.00
Grey frame door	693.355.95	293.356.01
High gloss white door	493.355.96	—
Oak effect door	293.355.97	—
Concrete effect door	093.355.98	093.356.02



**ENHET A112 storage combination for laundry  
W90×D32×H180 cm.**

This combination offers a perfect mix of open and closed storage – and a tailored space for a washing machine and laundry bin. This laundry solution works just as well in the kitchen as in the bathroom or laundry room. The wall cabinets are perfect for storing towels and linen free from dust or to hide cluttering cleaning supplies. By utilising the wall space for storage, you can use the floor space underneath for a washing machine and laundry bin. The open wall frame puts detergents within arm's reach of the washing machine.

This combination with	White frame	Anthracite frame
White basic door	193.315.09	493.315.03
White frame door	—	693.315.02
Grey frame door	393.315.08	893.315.01
High gloss white door	793.315.06	—
Oak effect door	293.315.04	—
Concrete effect door	993.315.05	593.314.99



**ENHET A113 wall storage combination  
W40×D17×H150 cm.**

This combination is a perfect mix of open and closed storage that hides the clutter and puts everyday essentials close at hand. The wall cabinet hides the clutter and keeps things free from dust. The open wall frame makes good use of the space under the cabinet. It gives a good overview and easy access to jars, bottles and things often used. By utilising the wall space for storage, you can use the floor space underneath for other things like a laundry basket or waste bin. This combination also includes ENHET swivel shelf which gives you quick and easy access to smaller items like your spice jars.

This combination with	White frame	Anthracite frame
White basic door	793.314.98	093.314.92
White frame door	993.314.97	293.314.91
Grey frame door	—	493.314.90
High gloss white door	393.314.95	—
Oak effect door	893.314.93	—
Concrete effect door	693.314.94	—



**ENHET A114 storage combination for laundry  
W120×D32×H150 cm.**

This combination gives you a space where you can hang your clothes to dry. This laundry solution works just as well in the kitchen as in the bathroom or laundry room. The open wall frame is perfect for storing towels, baskets and other things often used – all within arm's reach. The wall cabinet keeps detergents and cleaning supplies out of sight. The space under the cabinet and wall frame is just the right fit for a washing machine and laundry bin. You could also add a rail with hooks to hang laundry. Sold separately.

This combination with	White frame	Anthracite frame
White basic door	893.314.88	193.314.82
White frame door	093.314.87	393.314.81
Grey frame door	—	593.314.80
High gloss white door	493.314.85	—
Oak effect door	993.314.83	—
Concrete effect door	793.314.84	793.314.79



**ENHET A115 wall storage combination**  
**W60×D32×H180 cm.**

This high cabinet and open wall frame make it possible to utilise the wall space for storage while also saving floor space. The high cabinet provides ample storage for food. The open wall frame gives a good overview and easy access to jars, bottles and things often used. ENHET hanging shelf insert lets you organise your things and create space for more in the open ENHET frames. Perfect for glasses or espresso cups.

This combination with	White frame	Anthracite frame
White basic door	993.314.78	093.314.73
White frame door	193.314.77	293.314.72
Grey frame door	—	493.314.71
High gloss white door	393.314.76	—
Oak effect door	593.314.75	—
Concrete effect door	893.314.74	293.314.67



**ENHET A116 wall storage combination**  
**W80×D32×H150 cm.**

This combination hides the clutter and puts the things you love on display. The wall cabinet provides ample storage for food. The open wall frame gives a good overview and easy access to jars, bottles and things often used. The space under the open frame is perfect for hanging towels, placing freestanding waste bin, bench or why not use it to park your trolley? This combination can also serve as a laundry station with storage for detergents and space under the open frame for your washing machine. This combination also includes ENHET swivel shelf which gives you quick and easy access to smaller items like your spice jars.

This combination with	White frame	Anthracite frame
White basic door	993.314.64	493.314.52
White frame door	—	—
Grey frame door	393.314.62	093.314.49
High gloss white door	793.314.60	—
Oak effect door	993.314.59	—
Concrete effect door	393.314.57	—



**ENHET A117 wall storage combination**  
**W120×D32×H225 cm.**

This combination with a mix of open and closed storage hides the clutter and creates an exciting eye-catcher in between. The wall cabinet provides ample storage for food. The open wall frame makes good use of the space in between the cabinets. A perfect spot for putting your favourite jars, bottles and things often used.

This combination with	White frame	Anthracite frame
White basic door	493.314.47	993.314.35
White frame door	—	493.314.33
Grey frame door	693.314.46	093.314.25
High gloss white door	393.314.43	—
Oak effect door	—	—
Concrete effect door	793.314.41	393.314.24



**ENHET A118 wall storage combination**  
**W30×D30×H180 cm.**

This frame makes the most out of a narrow space, offering generous storage, easy access and a great overview of all your things. This open high frame offers ample storage without taking up too much floor space. It gives a good overview and easy access to things you often use. This combination also includes ENHET hanging shelf insert which helps create more storage space between the shelves in the open ENHET frames. Perfect for organising things like espresso cups or jars.

This combination with	White frame	Anthracite frame
	593.314.23	393.314.19

# ENHET doors and drawer fronts

---

## Show your true colours

Whether you are set on a classic one-coloured look or prefer a funkier mix of different hues, ENHET offers a range of doors that will accommodate your wishes. There are basic colours that bring a clean, bright and fresh look to your kitchen which you can match with every colour of the rainbow, and doors with patterns or a high-gloss finish if you like an industrial and modern style. Naturally, you can also mix colours and

patterns for a truly personalised kitchen, and combine closed doors with open shelves for a more playful expression. No matter the style you choose, the surface of the doors is easy to keep clean and resists moisture, scratches and bumps, which means that your kitchen is well prepared to handle years of daily wear and tear.

**10**

ENHET Kitchen doors have a 10-year guarantee.



# ENHET door and drawer front styles



## White

With white doors and drawer fronts you create a clean, bright and fresh expression that you can match with accents in all colours of the rainbow. Easy to enjoy and always in style.

### Door

60×60 cm	504.521.55
40×75 cm	304.521.61
60×75 cm	904.521.63
30×180 cm	204.521.66

### Front for dishwasher

45×75 cm	<b>004.997.73</b>
60×75 cm	<b>904.521.63</b>

### Drawer front

40×15 cm	404.521.65
60×15 cm	504.521.60
80×15 cm	704.521.59
40×30 cm, 2-p	704.521.64
60×30 cm, 2-p	804.521.68
80×30 cm, 2-p	904.521.58

### Drawer front for base cabinet for oven

60×14 cm	604.574.78
----------	------------



## White frame

A white surface with a wide frame is like an empty canvas where your choice of accessories and accent colours sets the style. Modern or classic – you decide.

### Door

60×60 cm	804.577.26
40×75 cm	004.577.25
60×75 cm	604.577.27
30×180 cm	504.577.23

### Front for dishwasher

45×75 cm	<b>804.997.74</b>
60×75 cm	<b>604.577.27</b>

### Drawer front

40×15 cm	404.521.65
60×15 cm	504.521.60
80×15 cm	704.521.59
40×30 cm, 2-p	204.577.29
60×30 cm, 2-p	804.577.31
80×30 cm, 2-p	404.577.33

### Drawer front for base cabinet for oven

60×14 cm	604.574.78
----------	------------



## Grey frame

With grey as a base, you create a warm and cosy feeling. Perfect if you want a discreet colour that goes with everything. Modern or classic – you decide the style.

### Door

60×60 cm	004.576.69
40×75 cm	204.576.68
60×75 cm	804.576.70
30×180 cm	604.576.66

### Front for dishwasher

45×75 cm	<b>604.997.70</b>
60×75 cm	<b>804.576.70</b>

### Drawer front

40×15 cm	604.576.71
60×15 cm	204.576.73
80×15 cm	704.576.75
40×30 cm, 2-p	404.576.72
60×30 cm, 2-p	004.576.74
80×30 cm, 2-p	504.576.76

### Drawer front for base cabinet for oven

60×14 cm	304.576.77
----------	------------



### High gloss white

The light reflects on this glossy surface and creates a clean, modern expression. Suits everyone from the choosy minimalist to the wild family with kids and is easy to wipe clean.

**Door**

60×60 cm	804.577.12
40×75 cm	004.577.11
60×75 cm	604.577.13
30×180 cm	404.577.09

**Front for dishwasher**

45×75 cm	<b>404.997.71</b>
60×75 cm	<b>604.577.13</b>

**Drawer front**

40×15 cm	404.577.14
60×15 cm	904.577.16
80×15 cm	504.577.18
40×30 cm, 2-p	104.577.15
60×30 cm, 2-p	704.577.17
80×30 cm, 2-p	304.577.19

**Drawer front for base cabinet for oven**

60×14 cm	104.577.20
----------	------------



### Oak effect

Good sense and feel in beautiful partnership. The foil surface is easy to keep clean and resists moisture, scratches and bumps, while the wood pattern creates a lively and warm expression.

**Door**

60×60 cm	604.576.47
40×75 cm	804.576.46
60×75 cm	404.576.48
30×180 cm	304.576.44

**Front for dishwasher**

45×75 cm	<b>204.997.72</b>
60×75 cm	<b>404.576.48</b>

**Drawer front**

40×15 cm	204.576.49
60×15 cm	804.576.51
80×15 cm	904.576.55
40×30 cm, 2-p	004.576.50
60×30 cm, 2-p	604.576.52
80×30 cm, 2-p	704.576.56

**Drawer front for base cabinet for oven**

60×14 cm	504.576.57
----------	------------



### Concrete effect

This is a perfect choice if you want to create a modern, industrial expression that feels warm and inviting. The pattern is reminiscent of concrete and the foil is both durable and easy to care for

**Door**

60×60 cm	704.576.99
40×75 cm	904.576.98
60×75 cm	304.577.00
30×180 cm	304.576.96

**Front for dishwasher**

45×75 cm	<b>804.997.69</b>
60×75 cm	<b>304.577.00</b>

**Drawer front**

40×15 cm	104.577.01
60×15 cm	704.577.03
80×15 cm	204.577.05
40×30 cm, 2-p	904.577.02
60×30 cm, 2-p	504.577.04
80×30 cm, 2-p	004.577.06

**Drawer front for base cabinet for oven**

60×14 cm	804.577.07
----------	------------

# ENHET cabinets and frames

---

## Keep an open mind!

In an ever-changing world, the only thing you can be certain of is that you and your home will have to change with it. That is why ENHET offers so many combinations that can be adapted over time to accommodate any life situation – or simply a change in taste.

With this range of cabinets and frames you can create a kitchen that fits both your needs and personality. The open wall frames make good use of the space

above the sink and worktop, perfect for hanging utensils or placing your tableware and other things that you often use. The choice of wide and narrow cabinets, as well as deep and shallow frames, gives you a great opportunity to use your space efficiently. Easily adaptable, and with a 10-year guarantee, this practical kitchen will be your companion for years to come.

**10**

ENHET kitchen system has a 10-year guarantee.



## ENHET closed cabinets

ENHET is functional and easy to plan. Pick the combinations you like, then choose appliances, sinks, taps knobs and handles. Done!



**ENHET wall cabinet with shelf**, 60×30×60 cm. This wall cabinet is perfect for bottles and jars – giving you a good overview. Make it your own with your favourite ENHET door. May be fitted over a wall-mounted extractor hood. It will align with a row of ENHET wall cabinets (height 75 cm) and create a uniform expression. Turns the space over your extractor hood into useful storage space.

White	904.404.29
-------	------------



**ENHET wall cabinet with 2 shelves**. This wall cabinet is perfect for bottles and jars – giving you a good overview. Make it your own with your favourite ENHET door. A wall cabinet with 2 shelves that makes good use of your wall space and puts the things you use often within easy reach.

<b>40×15×75 cm</b>	
White	104.404.47
Grey	004.404.43
<b>60×15×75 cm</b>	
White	204.404.56
Grey	404.404.55
<b>80×15×75 cm</b>	
White	404.404.41
Grey	304.404.51



**ENHET wall cabinet with 2 shelves**. This wall cabinet is perfect for bottles and jars – giving you a good overview. Make it your own with your favourite ENHET door. This wall cabinet with 2 shelves puts bottles, jars and things often used within easy reach. Closed storage creates a calm and more uniform expression in your room than open storage.

<b>40×30×75 cm</b>	
White	104.404.28
<b>60×30×75 cm</b>	
White	504.404.12
<b>80×30×75 cm</b>	
White	604.404.16



**ENHET high cabinet with 4 shelves**. This high cabinet provides roomy storage without taking up precious floor space. It provides ample storage for food without taking up too much floor space. Perfect for making the best use of wall space in smaller spaces.

<b>30×30×180 cm</b>	
White	104.404.52
Grey	204.404.42



**ENHET base cabinet with shelf**. This cabinet with shelf is perfect for things like pots, bowls or small appliances. Make it your own with your favourite ENHET door. A cabinet with a shelf that provides space for storing cooking equipment like bowls or small appliances.

<b>40×60×75 cm</b>	
White	104.404.14
<b>60×60×75 cm</b>	
White	204.404.23
<b>80×60×75 cm</b>	
White	804.404.20



**ENHET base cabinet with 3 drawers**. This cabinet has 3 drawers for the smallest utensils to the largest pots. Make it your own with your favourite ENHET drawer fronts. A cabinet with 3 drawers for spacious storage of utensils, cutlery, pots and pans ¾ drawer extension for good overview and easy access to the content. Tailor the space inside your drawers with interior organisers, sold separately.

<b>40×60×75 cm</b>	
White	404.404.22
<b>60×60×75 cm</b>	
White	204.404.18
<b>80×60×75 cm</b>	
White	304.404.27



**ENHET corner panel**. Want to build a corner solution with base cabinets? This panel opens up to more possibilities to utilise your space. With the corner panel, you can divide your base cabinet to create a corner solution and attach an ENHET door (40×75 cm or 60×75 cm) to cover the opening. Fits ENHET base cabinets. Combine with ENHET base cabinet 80 cm and ENHET door (40×75 cm or 60×75 cm) to build a corner solution. Cabinet and door sold separately.

White	804.404.15
Grey	604.811.81
Oak effect	404.811.82



**ENHET base cabinet for oven with drawer**. This cabinet is designed for a built-in oven and you have the option to combine it with either a built-in hob or a portable hob. Dimensioned for built-in ovens 60×60 cm, with the option to combine with either a built-in hob or a portable hob. The air duct allows the warm air from the oven to circulate, preventing the temperature from getting too hot inside the cabinet. Extra storage space in the drawer for frying pans, baking trays or chopping boards. ¾ drawer extension for good overview and easy access to the content. For a uniform expression and easier cleaning, you can choose to hide the legs behind ENHET plinth.

<b>60×60×75 cm</b>	
White	304.404.13



**ENHET base cabinet for sink**. This cabinet is designed for a sink, tap and built-in waste sorting. Make it your own with your favourite ENHET door. Designed for sink and tap with space for piping in the back of the cabinet. May be completed with HÅLLBAR waste sorting solution. With waste sorting under the sink, you can reduce spills that come from moving waste from sink to bin. Choose to have the legs visible or hide them behind ENHET plinth for a more uniform expression and easier cleaning.

<b>60×60×75 cm</b>	
White	504.404.26

## Legs and plinth for closed cabinet



<b>ENHET legs for cabinet</b> , 12.5 cm, 2-p.	
White	104.490.18
Anthracite	904.490.19



<b>ENHET plinth</b> , 180×12 cm.	
White	704.563.55

## ENHET open frames

Hide the clutter behind closed cabinet doors and put your prettiest things on display in the open ENHET frames. Allowing you to express your personality through the items you choose to arrange on the shelves, the open storage creates a more dynamic and airier kitchen atmosphere. For even more personalisation opportunities, the frames come in different colours that you can mix and match any way that suits you.

Open storage also provides a good overview of all your kitchen items and you can keep the utensils you use the most on the shelves that are easiest to reach. With a mix of closed and open storage, it is possible to create a kitchen that doesn't only make preparing your everyday meals a breeze, but is a real eye-catcher that inspires you to cook and your friends and family to keep you company.



ENHET wall frame with shelves - 15 cm deep.

**40×15×75 cm**

White	704.489.35
Anthracite	304.489.37

**60×15×75 cm**

White	004.489.67
Anthracite	804.489.68



ENHET wall frame with shelves - 30 cm deep.

**40×30×75 cm**

White	904.489.44
Anthracite	604.489.45

**60×30×75 cm**

White	204.489.71
Anthracite	004.489.72



ENHET high frame with shelves.

**30×30×180 cm**

White	404.489.46
Anthracite	204.489.47

**60×30×180 cm**

White	804.489.54
Anthracite	704.489.64



ENHET base frame with shelves.

**40×60×75 cm**

White	204.489.52
Anthracite	004.489.53

**60×60×75 cm**

White	304.489.75
Anthracite	104.489.76



ENHET legs for open frames, 12.5 cm, 2-p. For use on ENHET open base frames with 60 cm depth and 75 cm height. The 12.5 cm high legs put base frames at a comfortable work height. Choose the colour you prefer to coordinate with your base frame and to add detail to the design of your room. Legs are adjustable from 11-13.5 cm to compensate any irregularities in the floor.

White	404.599.11
Anthracite	204.599.12

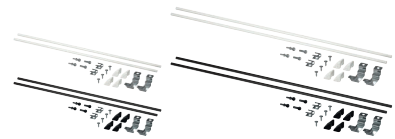

ENHET assembly kit for kitchen island (solution). This assembly kit lets you build the kitchen island you've always dreamed of. It's easy and it adds a new dimension to your kitchen. Allows you to connect 2 or 3 open ENHET base frames to create a freestanding kitchen island. The assembly kit stabilises the frames and also includes floor attachments. It is also possible to build a kitchen island with 1 open base frame (40x60x75 cm) fixed to the wall and 1 worktop (max. 80x60 cm). Fix the worktop to the wall with FIXA worktop support fitting galvanised. It is also possible to build a kitchen island with 1 open base frame (60x60x75 cm) fixed to the wall and 1 worktop (max. 80x60 cm). The worktop is fixed to the wall using FIXA worktop support fitting galvanised.

**40 cm**

White	204.801.74
Anthracite	704.801.76

**60 cm**

White	704.801.81
Anthracite	104.801.79

## ENHET accessories for open frame

You can easily add ENHET accessories to extend the use of your storage combination. And best of all – you don't have to drill.



**ENHET hanging shelf insert**, 26×28×15 cm. This insert adds a new dimension to your open ENHET frame. It divides the storage space and makes room for more things in no time – simply hang it in the grooves of the frame and get organised. You don't need any tools and don't have to drill holes in the wall. Perfect for glass, tableware and bowls in the kitchen and for small jars and bottles.

Anthracite	704.657.55
------------	------------



**ENHET swivel shelf**, 40×21 cm. Tired of looking for those things that tend to disappear in the kitchen? You can easily solve this by attaching this handy swivel shelf to any of the open frames in the ENHET series. The smart design allows you to fasten the shelf quickly and easily to any of the open frames in the ENHET series. You can find and reach the things you need by turning the shelf. Perfect to have as a spice rack by the hob to keep all the flavours close at hand when you are cooking.

Anthracite	204.657.34
------------	------------



**ENHET hook**, 6×24 mm, 2-p. With these hooks you can easily create room for more in the same space. Magic? Not at all, you just hang them in the grooves under the open ENHET frames. And best of all – you don't have to drill. You can hang these hooks in the grooves under the open ENHET frames – or on ENHET rail for hooks that is sold separately. With these hooks, you turn unused space into practical storage space. Perfect for everything from utensils and towels in the kitchen. Complement with SKATTÅN containers to hold/store things like cutlery or herbs.

White	004.657.54
Anthracite	604.657.51



**ENHET rail for hooks**. With this rail you can utilise every centimetre under your open ENHET frame for storage. In no time, you can hang both hooks and containers – without using tools or drill. Choose a colour that matches your other furnishings or adds an accent colour. With ENHET hooks and SKATTÅN container on the rail, you create plenty of space for everything from cutlery and utensils in the kitchen.

**37 cm**

White	104.657.39
Anthracite	704.657.36

**57 cm**

White	504.657.42
Anthracite	704.657.41



**SKATTÅN container**, 12×34 cm. Instead of storing things in drawers, you can have everything from cutlery and herbs to accessories close at hand. Easy to hang on a hook under the open ENHET wall frame. You can hang this container on a hook to quickly create space for cutlery and herbs in the kitchen. Turns space under open ENHET frames into practical storage space where you have everything close at hand. With small items in containers, it becomes easier to keep things in order on the worktop in the kitchen.

	304.657.57
--	------------



**TAVELÅN tray**, 2-p. With these decorative trays you make room for a lot, even in small spaces. If you stack them, they'll take up even less space. Fits perfectly in ENHET open wall frames (depth 15 or 30 cm), but you can of course use them wherever you want. Perhaps on the worktop, shelf, in a cabinet or drawer? Decorative, practical and easy to move if you need to use things elsewhere. The large tray accommodates everything from cutlery and spice mills. On the small tray you can store small spice bags. The drawers are made of bamboo – a durable, and fast-growing natural material that can withstand moisture and water splashes.

	504.657.56
--	------------



**ENHET**  
Hanging shelf insert.  
Anthracite, 26×28×15 cm. 704.657.55



# KNOXHULT kitchen

---

## When basic functions and low price matters

To make it easy for you, we've already combined ready sets with cabinets, doors, worktops, shelves, drawers, sink, tap and water-trap. All you have to do is to pick the finishing touches, like knobs, handles and appliances. If you bring it home from your local IKEA store in the morning, you can have it installed and ready for cooking

a late supper in the evening. Go to [ikea.co.uk](http://ikea.co.uk) to see all the ready-made sets. You can of course pick and choose exactly the KNOXHULT cabinets you want, too. On the next pages you'll see what choices you have.





KNOXHULT is functional and easy to plan. Pick the combinations you like, then choose appliances, sinks, taps knobs and handles. Done!

## Base cabinets

---



**KNOXHULT base cabinet for built-in oven**, 180 cm. Customise your storage with the smooth-running drawer and adjustable shelves. The laminate worktop is moisture-, heat- and scratch resistant. Frame and fronts are coated with foil which gives a scratch-resistant surface that is easy to keep clean. You can easily mount the door front in the correct position, as the hinges are adjustable in height, depth and width. Stands steady on uneven floors because it has adjustable feet

White

703.267.88

---



**KNOXHULT base cabinet with doors and drawer**, 120 cm. Customise your storage with the smooth-running drawer and adjustable shelves. The laminate worktop is moisture-, heat- and scratch resistant. The frame and fronts are coated with foil which gives a scratch-resistant surface that is easy to keep clean. You can easily mount the door front in the correct position, as the hinges are adjustable in height, depth and width. Stands steady on uneven floors because it has adjustable feet.

White

303.267.90

---



**KNOXHULT corner base cabinet**, 100 cm. Customise your kitchen by building an L- or U-shaped kitchens. The laminate worktop is moisture-, heat- and scratch resistant. Frame and fronts are coated with foil which gives a scratch-resistant surface that is easy to keep clean. You can easily mount the doors to open left or right and the hinges can be adjusted to position the doors at the exact height, width and depth. Stands steady on uneven floors because it has adjustable feet.

White

004.861.29

---



**KNOXHULT base cabinet with drawers**, 40 cm. Customise your storage with the smooth-running drawers. The laminate worktop is moisture-, heat- and scratch resistant. The frame and fronts are coated with foil which gives a scratch-resistant surface that is easy to keep clean. Stands steady on uneven floors because it has adjustable feet.

White

903.267.87

---

## Wall cabinets

---



**KNOXHULT wall cabinet with doors**, 120x75 cm. Customise your storage with the adjustable shelves. The frame and fronts are coated with foil which gives a scratch-resistant surface that is easy to keep clean. You can easily mount the door front in the correct position, as the hinges are adjustable in height, depth and width.

White

903.267.92

---



**KNOXHULT wall cabinet with door**, 60x60 cm. Customise your storage with the adjustable shelves. The frame and fronts are coated with foil which gives a scratch-resistant surface that is easy to keep clean. You can easily mount the door front in the correct position, as the hinges are adjustable in height, depth and width. Sized to have above your extractor hood.

White

103.267.91

---



**KNOXHULT wall cabinet with door**, 40x75 cm. Customise your storage with the adjustable shelves. The frame and fronts are coated with foil which gives a scratch-resistant surface that is easy to keep clean. You can easily mount the door front in the correct position, as the hinges are adjustable in height, depth and width.

White

503.267.89

---



**KNOXHULT wall cabinet**, 60x75 cm. Customise your storage with the adjustable shelves. The frame and fronts are coated with foil which gives a scratch-resistant surface that is easy to keep clean. You can easily mount the door front in the correct position, as the hinges are adjustable in height, depth and width.

White

404.963.10

---

## Accessories



**STÖDJA cutlery tray, 31x50 cm.**

White 501.772.23



**STÖDJA utensil tray, 20x50 cm.**

White 401.772.28



**SLAGSIDA LED worktop lighting.** Designed for KNOXHULT kitchen system. Dimmable in two steps with built in touch sensor. Easy installation as plug goes directly in wall socket. This luminaire contains built in LED lamps of the energy classes A++ to A. The lamps can not be changed in the luminaire.

40 cm. 5.2W, 320lm 504.000.67



**STÖDJA cutlery tray, 51x50 cm.**

White 001.772.25



**SMÄCKER cutlery tray, 31x26 cm.**

Grey 902.417.88



**SUNNERSTA adjustable rack with hooks, W45.7 cm.**  
Min. height 45 cm, max. height 65 cm.

White 204.409.51



**SUNNERSTA container, W12xD11xH13 cm.** Fits SUNNERSTA rail, trolley and mini-kitchen, adjustable rack, rail, trolley and mini-kitchen.

White 503.037.35

Blue 704.405.24

Pale green 904.405.23

Red 104.405.22



**SUNNERSTA hook, 5-p.**

White 403.037.26



**SUNNERSTA kitchen roll holder,**  
W24.5xD11.5xH4.7cm. Max. load 1 kg.

White 204.439.21



**SUNNERSTA rail with 4 hooks/2 containers.**  
L60xH14xD13 cm. Including 1 rail, 2 containers and 4 hooks.

White 404.545.60



**SUNNERSTA shelf 25, W25xD14xH5 cm.** Max. load 2 kg.

White 904.439.27



**SUNNERSTA shelf/dish drainer,**  
W36.5xD15 cm. Max. load 4 kg.

White 304.439.30



**SUNNERSTA kitchen organiser set, no drill/dish drainer/shelf/kitchen roll holder/container.** W23 cm. Min. height 45 cm, max height 65 cm.

White 193.384.26



**SUNNERSTA kitchen organiser set, no drill/kitchen roll holder/dish drainer/container.** W23 cm. Min. height 45 cm, max height 65 cm.

White 693.384.24

# SUNNERSTA mini-kitchen

## Flexible and affordable

With SUNNERSTA mini-kitchen you can create an open and welcoming kitchen even if space is limited. It's also great for dorm rooms and guest houses. Use the hooks and containers to keep track of utensils, and use the trolley as a utility surface when there's a lot going on in

the kitchen. By adding TILLREDA appliances, you'll have everything you need. This affordable and flexible kitchen is easy to buy, get home, install and move to new places.



**SUNNERSTA mini-kitchen,**  
W112×D56×H139 cm. Refer to sinks  
and taps chapter.

903.020.79



**SUNNERSTA trolley.**  
L56×W33×H97 cm.

White 703.037.20



**SUNNERSTA hook, 5-p.**

White 403.037.26



**SUNNERSTA container,**  
W12×D11×H13 cm. Fits SUNNERSTA rail,  
trolley and mini-kitchen, adjustable  
rack, rail, trolley and mini-kitchen.

White 503.037.35

Blue 704.405.24

Pale green 904.405.23

Red 104.405.22



**SUNNERSTA kitchen roll holder,**  
white. Max. load 1 kg.

W24.5×D11.5×H4.7 cm 204.439.21

W28.4×11.5×H4.7 cm 305.098.03



**SUNNERSTA rail with 4 hooks/2 con-  
tainers.** L60×H14×D13 cm. Including 1  
rail, 2 containers and 4 hooks.

White 404.545.60



**SUNNERSTA shelf/dish drainer,**  
W36.5×D15 cm. Max. load 4 kg.

White 304.439.30



**SUNNERSTA shelf 25,**  
W25×D14×H5 cm. Max. load 2 kg.

White 904.439.27



# Lighting and sound

---

## A brighter kitchen life

Good lighting is an essential part of any kitchen. That's why we offer four integrated lighting series perfectly dimensioned to fit our kitchen cabinets. Having integrated lighting in your kitchen is a great way to show off your favourite dinnerware behind glass doors or in drawers. And, good lighting brings alive your cabinet doors, worktop and wall panels, too.

Get an even better kitchen life with the ability to dim, change from warm to cold light, turn off and turn on light wirelessly. All you need is TRÅDFRI remote con-

trol. Or, use the TRÅDFRI gateway and IKEA Home smart app to control every beam of light with your smartphone. We call it IKEA Smart lighting.

Sound is a powerful mood booster, much in the same way as light. Both are crucial for creating the right atmosphere at home and both are deeply personal – each of us has our own unique preferences in terms of volume, brightness, type, and genre. Like light, sound is culturally and socially important; it brings people together.



### **Kitchen installation**

If you want we can install all your kitchen lighting for you, as a part of our Kitchen Installation service.



**Sound** has the ability to change the atmosphere at home dramatically. So, turning a grey day into a great day is only a touch of a button away.



**Drawer lighting** simplifies finding what you need even during those midnight kitchen raids. Opening and closing the drawer turns the light on and off automatically.



**Spotlights** provide a focused light that is good for lighting smaller areas and behind glass doors.



**Worktop lighting** should give you a clean, clear view of all the work you're doing in the kitchen.



**Cabinet lighting** illuminates your favourite kitchen doors and creates cosy mood light in the entire kitchen.

## Lighting for METOD

### MITTLED series



MITTLED has compact design and is easy to install. MITTLED uses only one connection cord per row of light as each element connects to the next one in easy way.



**MITTLED LED worktop lighting.** Matches your cabinet sizes and features a compact design. To be completed with TRÅDFRI LED driver, VÅGDAL connection cord and FÖRNIMMA power supply cord sold separately. Dimmable with TRÅDFRI wireless dimmer and TRÅDFRI gateway, sold separately.

Aluminium- colour	
20 cm, 2.0W, 150lm	405.383.10
30 cm, 3.0W, 240lm	405.283.87
40 cm, 4.0W, 300lm	405.285.61
60 cm, 5.5W, 480lm	105.285.72
80 cm, 7.5W, 640lm	905.285.92
White	
20 cm, 2.0W, 150lm	104.570.89
40 cm, 4.0W, 300lm	905.285.68
60 cm, 5.5W, 480lm	805.285.83
80 cm, 7.5W, 640lm	305.286.13



**MITTLED LED lighting strip for drawers.** In an IKEA kitchen you can get lighting for all your drawers, that way you'll always be able to find what you need even during those midnight kitchen raids. Opening and closing the drawer turns the light on and off automatically. To be completed with ANSLUTA LED driver with cord 19W, sold separately.

White	
36 cm, 2.0W, 50lm	304.635.17
56 cm, 2.0W, 50lm	804.635.48



**MITTLED LED spotlight.** Provides a focused light that is good for lighting smaller areas. To be completed with TRÅDFRI LED driver and FÖRNIMMA power supply cord sold separately. Dimmable with TRÅDFRI wireless dimmer and TRÅDFRI gateway, sold separately. Can be installed in its housing or integrated into coving. Ø6.8 cm.

Aluminium- colour	
2.2W, 150lm	104.353.99
Black	
2.2W, 150lm	605.286.59
White	
2.2W, 150lm	205.286.61

## IRSTA series



IRSTA is a modern and very thin LED lighting, which covers the entire underside of the wall cabinet to illuminate an even light over the entire worktop.



**IRSTA LED worktop lighting.** A modern and very thin LED lighting which covers the entire underside of the wall cabinet and therefore provides an even lighting spread over the entire worktop. To be completed with TRÅDFRI LED driver and FÖRNIMMA power supply cord, sold separately. Dimmable with TRÅDFRI wireless dimmer and TRÅDFRI gateway, sold separately.

40 cm	4.5W, 300lm	104.069.43
60 cm	7W, 450lm	204.069.47
80 cm	8.5W, 600lm	404.069.51

## Cabinet lighting



Cabinet lighting illuminates your favourite kitchen doors and creates a cosy mood light in the entire kitchen. URSHULT and LINDSHULT cabinet lighting all include energy saving LED and can be controlled using TRÅDFRI wireless dimmer and gateway.



**LINDSHULT LED cabinet lighting.** Provides a focused light that is good for lighting smaller areas. To be completed with TRÅDFRI LED driver and FÖRNIMMA power supply cord. Dimmable with TRÅDFRI wireless dimmer and TRÅDFRI gateway, sold separately.

Nickel-plated		
2W, 80lm		102.604.36

## Lighting for KNOXHULT

### SLAGSIDA series



This worktop lighting is designed for KNOXHULT kitchen and helps you create a functional workspace. Easy to install on your own with a connected power plug and is dimmable in two steps with a touch sensor.



**SLAGSIDA LED worktop lighting.** This worktop lighting has a power plug so you can easily install it yourself and don't need a certified electrician.

40 cm	5.3W, 320lm	504.000.67
60 cm	6.6W, 480lm	103.556.51

## Lighting for ENHET

### SKYDRAG series



SKYDRAG lighting kit is designed for the ENHET series - perfect both as worktop lighting and to create ambience in the kitchen. With the TRÅDFRI driver and the wireless dimmer you can easily turn on, off and dim your lighting.



**SKYDRAG LED worktop/wardrobe lighting strip with sensor, dimmable.**

<b>40 cm</b>	
White	504.395.88
Anthracite	904.396.28
<b>60 cm</b>	
White	304.395.89
Anthracite	304.396.12
<b>80 cm</b>	
White	104.395.90

### SKYDRAG – perfect fit for ENHET

Lighting creates atmosphere in homes and makes everyday life easier. This LED lighting strip is specially

designed for the ENHET series, but is of course just as easy to install in an existing kitchen.



**Perfect fit to ENHET Kitchen code 100, 101, 103**  
SKYDRAG/TRÅDFRI lighting kit nr 1.  
Anthracite 093.856.49  
SKYDRAG/TRÅDFRI lighting kit nr 2  
White 894.184.48



**Perfect fit to ENHET Kitchen code 102, 104, 105, 106, 111, 112**  
SKYDRAG/TRÅDFRI lighting kit nr 3  
Anthracite 694.184.49  
SKYDRAG/TRÅDFRI lighting kit nr 4  
White 494.184.50



**Perfect fit to ENHET Kitchen code 109, 115, 117, 500, 501, 502**  
SKYDRAG/TRÅDFRI lighting kit nr 5  
Anthracite 294.184.51  
SKYDRAG/TRÅDFRI lighting kit nr 6  
White 094.184.52



**Perfect fit to ENHET Kitchen code 110, 118, 503**  
SKYDRAG/TRÅDFRI lighting kit nr 7  
Anthracite 894.184.53  
SKYDRAG/TRÅDFRI lighting kit nr 8  
White 694.184.54



**Perfect fit to ENHET Kitchen code 107, 113**  
SKYDRAG/TRÅDFRI lighting kit nr 9  
Anthracite 394.184.55  
SKYDRAG/TRÅDFRI lighting kit nr 10  
White 393.856.43



**Perfect fit to ENHET Kitchen code 108, 119**  
SKYDRAG/TRÅDFRI lighting kit nr 11  
Anthracite 994.184.57  
SKYDRAG/TRÅDFRI lighting kit nr 12  
White 794.184.58



**Perfect fit to ENHET Kitchen code 116, 506**  
SKYDRAG/TRÅDFRI lighting kit nr 14  
Anthracite 594.184.59  
SKYDRAG/TRÅDFRI lighting kit nr 15  
White 394.184.60



**Perfect fit to ENHET Kitchen code 120**  
SKYDRAG/TRÅDFRI lighting kit nr 16  
Anthracite/white 294.184.46  
SKYDRAG/TRÅDFRI lighting kit nr 17  
White 194.184.61



**Perfect fit to ENHET Kitchen code 121, 504, 507,**  
SKYDRAG/TRÅDFRI lighting kit nr 18  
Anthracite 994.184.62  
SKYDRAG/TRÅDFRI lighting kit nr 19  
White 794.184.63



**Perfect fit to ENHET Kitchen code 122**  
SKYDRAG/TRÅDFRI lighting kit nr 20  
Anthracite 594.184.64  
SKYDRAG/TRÅDFRI lighting kit nr 21  
White 294.184.65



**Perfect fit to ENHET Kitchen code 505**  
SKYDRAG/TRÅDFRI lighting kit nr 22  
Anthracite 094.184.66  
SKYDRAG/TRÅDFRI lighting kit nr 23  
White 894.184.67



**Perfect fit to ENHET Kitchen code 508**  
SKYDRAG/TRÅDFRI lighting kit nr 24  
Anthracite 694.184.68  
SKYDRAG/TRÅDFRI lighting kit nr 25  
White 294.184.70



**Perfect fit to ENHET Kitchen code 114, 123**  
SKYDRAG/TRÅDFRI lighting kit nr 26  
Anthracite/white 094.184.71  
SKYDRAG/TRÅDFRI lighting kit nr 27  
White 894.184.72

## Cords and IKEA LED driver



**FÖRNIMMA power supply cord 3.5m.** With this cord, you can connect up to 10 series-connected lamps to the power grid – and turn on, turn off and dim all of them at the same time with TRÅDFRI wireless dimmer.

104.468.83



**FÖRNIMMA intermediate connection cord.** Can be used as a direct connection between TRÅDFRI LED drivers, e.g. between two sections of wall cabinets, with one single connection to the mains supply.

L0.7 m 903.947.00  
L2 m 303.946.99



**VÅGDAL connection cord, 3.5 m.** With this cord you can connect MITTLED worktop lighting with IKEA LED driver.

White 704.636.00



**ANSLUTA LED driver 19W.** Use this driver if you want turn all connected light sources on and off with a single switch.

White 704.058.65

## TRÅDFRI series



With the TRÅDFRI gateway you can control all your TRÅDFRI driver connected lighting via the IKEA Home smart app or your voice assistant. Create moods and set scenes together with other IKEA Smart lighting.



**TRÅDFRI gateway.** With TRÅDFRI gateway and app you can control each light source individually, create different types of lighting settings - and control them by the IKEA Home smart app or personal assistant via for example Apple HomeKit, Amazon Alexa or Google Home.

White 893.191.65



**TRÅDFRI wireless dimmer.**

White 704.085.95



**STYRBAR remote controle.** With this remote controle you can turn on and off, switch between different tones and dim for the right mood.

Stainless steel 004.680.45



**TRÅDFRI remote control.** You can use the remote to dim your TRÅDFRI connected integrated lighting.

White 304.431.24

## SYMFONISK speakers



Sound has the ability to change the atmosphere at home dramatically. So, turning a grey day into a great day is only a touch of a button away. Hang the SYMFONISK WiFi Bookshelf speaker on a KUNGSFORS kitchen rail, saving precious space on your worktop. The SYMFONISK speaker hooks have a soft damping material so it reduces speaker rattling when hung on a rail.



**SYMFONISK WiFi bookshelf speaker.** Place the speaker horizontally or vertically, or mount it on the wall to use as a practical shelf. Also helps you to use your space optimally, while providing a rich sound that fills the entire room.

Black 803.575.57  
White 505.065.87



**SYMFONISK speaker hook.** Hang SYMFONISK WiFi bookshelf speaker on the wall to save space in your kitchen. With this speaker hook you can easily hang it on a rail like KUNGSFORS or FINTORP – saving precious space on your worktop.

Black 504.443.25



**SYMFONISK sound remote.** Put on the right tune for all occasions – from the kitchen, bedroom or wherever you are at home. With this sound remote, you control SYMFONISK speaker and other Sonos speakers from the entire home. Complete with TRÅDFRI gateway, sold separately.

Black 404.337.80  
White 603.704.80



Download the Sonos app to set up your SYMFONISK speakers and start streaming music from all devices – smartphones, tablets, and computers. When friends come over they can download the app and play DJ, too.



# Worktops

---

Your kitchen is the heart of your home, it's a room for everyone! How it performs and how it looks are two important factors. Even though doors and drawer fronts are the main style decision you make when updating your kitchen, your worktop can have a big impact on the overall look. However, the perfect worktop is not just about completing the look of your kitchen, it has an impact on its functionality too. When picking the right worktop there are many factors to

consider, including your style, durability, maintenance, lifestyle and cost. Our worktops are available in pre-cut and custom made as well as in a wide range of durable materials, finishes and thicknesses. Each surface has unique properties, with differing levels of water, wear and heat resistance.

## How to choose your worktop:

### 01

---

**What's your budget?**  
A stylish look does not have to cost a fortune, our worktops are available in wide range of materials and expressions, pre-cut as well as custom-made to perfectly fit your style, needs and wallet.

### 02

---

**What kind of material do you prefer?** When deciding on material, consider how robust you need your worktop to be, how much you are prepared to look after it, and how you want it to look in your kitchen scheme.

### 03

---

**Custom made worktops** are made to fit your kitchen layout, you can order the exact length and depth you need, as well as cut-outs for your sink, tap and hob. **Pre-cut worktops** are available in different sizes, you can take yours home today and cut it to desired length.

**25**

All worktops have a 25-year guarantee.

### **Built to last**

When we test our worktops we put them up against everything they'll face in your kitchen: liquids, oil, steam, heat, thumps, bumps and scratches. Once we're done we're so sure our worktops will last, we guarantee it.



---

## Materials

### Laminate

Laminate worktops are affordable, easy to maintain and there are lots of colours and expressions to choose from. They are made of laminate pressed onto particleboard. Both heat and pressure are applied to harden the surface and create a durable worktop.

### Thick veneer

Thick wood veneer worktops offer the natural colour and grain of wood, adding warmth to your kitchen. They are pre-treated for quicker installation and can be sanded and treated when needed. The thick veneer technique allows us to create patterns and expressions that are otherwise difficult and expensive to achieve – with the efficient use of natural resources.

### Acrylic

Acrylic worktops have a smooth, non-porous surface that is resistant to stains and moisture, making them easy to clean. The colour and design run all the way through the material. This means they can be polished to remove any surface damage such as scratches, allowing you to restore the surface to its original condition.

### Quartz

Quartz worktops are extremely durable, resistant to scratches, moisture and impacts. They are made by combining ground quartz (one of the hardest materials in nature), resins and pigments. This creates a very hard, non-porous surface that is smooth, easy to clean and does not require any sealing treatment. Our quartz worktops are 2 or 3 cm thick and come in a wide variety of expressions.

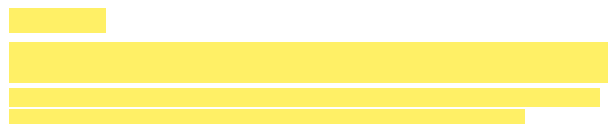

## Laminate worktops 2.8 cm thick



EKBACKEN and LILLTRÄSK laminate worktops are 2.8 cm thick and have a rounded edge. They are durable, easy to maintain, and come in an extensive range of colours and textures (standard, matte, high gloss and even soft-touch).

EKBACKEN laminate worktops are available as pre-cut (take home today) or custom-made, with more edge and size options. Pre-cut worktops can be cut to the exact length you need and finished with the edge strip included in the package.

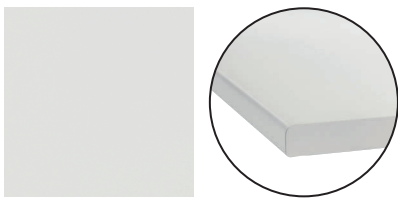

**LILLTRÄSK worktop**, white, D63.5 cm.

**Take home today:**

L186×T2.8 cm	502.427.23
L246×T2.8 cm	902.427.21

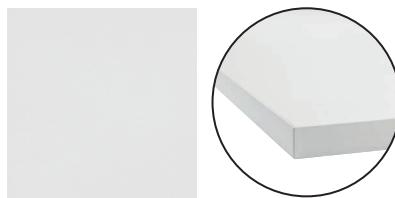

**EKBACKEN worktop**, double-sided, white with white edge, D63.5 cm.

**Take home today:**

L186×T2.8 cm	402.913.42
L246×T2.8 cm	202.913.43

**Custom made:**

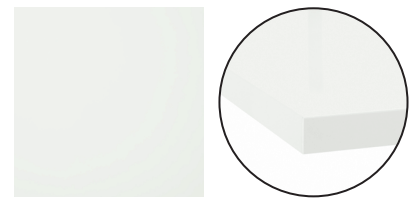

**EKBACKEN worktop**, high-gloss white.

**Custom made:\***

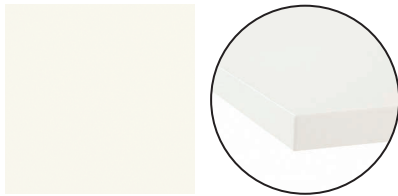

**EKBACKEN worktop**, off-white laminate.

**Custom made:\***



**EKBACKEN worktop**, white marble effect, D63.5 cm.

**Take home today:**

L186×T2.8 cm	703.356.22
L246×T2.8 cm	003.356.25

**Custom made:\***

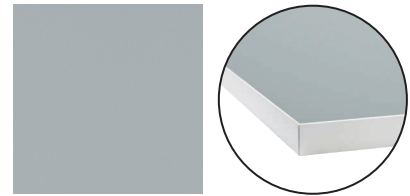

**EKBACKEN worktop**, double-sided, light grey with white edge, D63.5 cm.

**Take home today:**

L186×T2.8 cm	402.913.42
L246×T2.8 cm	202.913.43

**Custom made:\***

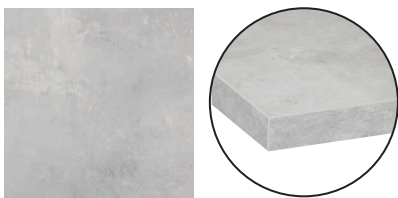

**EKBACKEN worktop**, light grey concrete effect, D63.5 cm.

**Take home today:**

L186×T2.8 cm	303.954.39
L246×T2.8 cm	503.954.43

**Custom made:\***

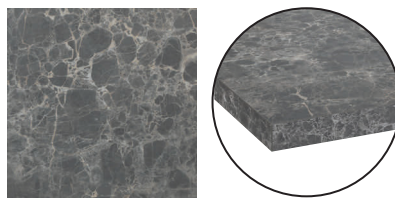

**EKBACKEN worktop**, dark grey/marble effect laminate, D63.5 cm.

**Take home today:**

L186×T2.8 cm	403.971.69
L246×T2.8 cm	403.971.74

**Custom made:\***

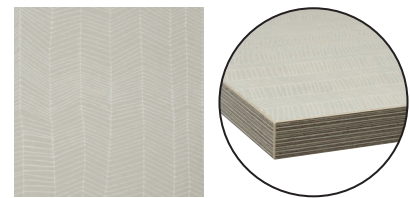

**EKBACKEN worktop**, matt beige patterned/laminate, D63.5 cm.

**Take home today:**

L186×T2.8 cm	003.971.85
L246×T2.8 cm	203.971.89

**Custom made:\***



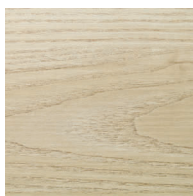

**EKBACKEN worktop**, ash effect, D63.5 cm.

**Take home today:**

L186×T2.8 cm	503.376.17
L246×T2.8 cm	903.376.20

**Custom made:\***

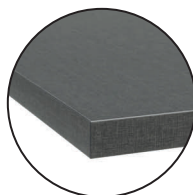
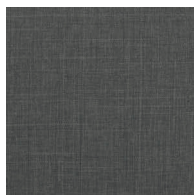

**EKBACKEN worktop**, dark grey linen effect, D63.5 cm.

**Custom made:\***

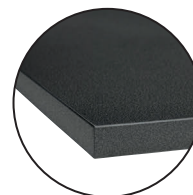

**EKBACKEN worktop**, black stone effect, D63.5 cm.

**Take home today:**

L186×T2.8 cm	302.743.62
L246×T2.8 cm	902.743.64

**Custom made:\***

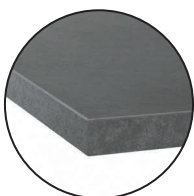
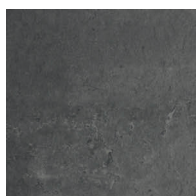

**EKBACKEN worktop**, concrete effect, D63.5 cm.

**Take home today:**

L186×T2.8 cm	203.356.48
L246×T2.8 cm	603.356.51

**Custom made:\***

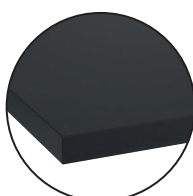
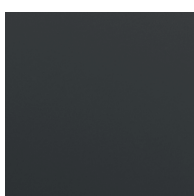

**EKBACKEN worktop**, matt anthracite, D63.5 cm.

**Take home today:**

L186×T2.8 cm	004.090.13
L246×T2.8 cm	104.090.17

**Custom made:\***



## Laminate worktops 3.8 cm thick



SÄLJAN are **have a rounded** or straight edge. They are durable, easy to maintain, and come in a wide range of colors and textures (standard, high gloss and even double-sided).

SÄLJAN and HÄLLESTAD laminate worktops are available as pre-cut (take home today) or custom-made, with more edge and size options. Pre-cut worktops can be cut into the exact length you need and finished with the edge strip included in the package.

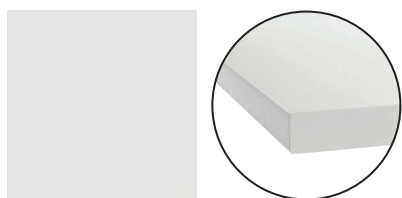

SÄLJAN worktop, white, D63.5 cm.

**Take home today:**

L186×T3.8 cm	502.022.08
L246×T3.8 cm	602.022.17

**Custom made:\***

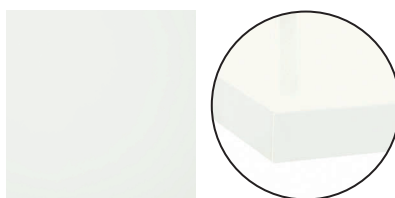

SÄLJAN worktop, high-gloss white.

**Custom made:\***



SÄLJAN worktop, oak effect.

**Custom made or Take home today:**

L186×T3.8 cm	604.391.73
L246×T3.8 cm	804.392.09

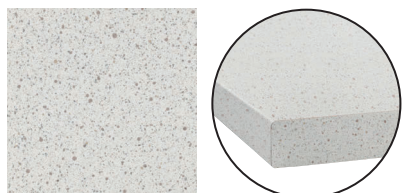

SÄLJAN worktop, white stone effect, D63.5 cm.

**Take home today:**

L186×T3.8 cm	503.830.54
L246×T3.8 cm	203.830.55

**Custom made:\***

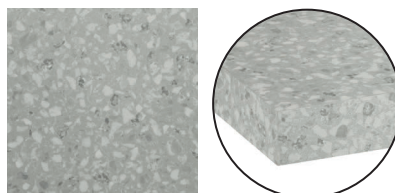

SÄLJAN worktop, light grey/mineral effect laminate, D63.5 cm.

**Take home today:**

L186×T3.8 cm	503.972.01
L246×T3.8 cm	603.972.05

**Custom made:\***



SÄLJAN worktop, beige stone effect.

**Custom made or Take home today:**

L186×T3.8 cm	404.391.26
L246×T3.8 cm	604.391.30

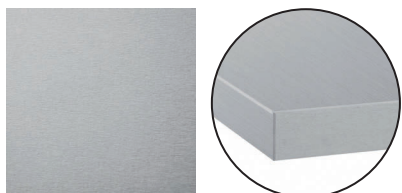

SÄLJAN worktop, aluminum effect.

**Custom made:\***



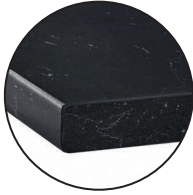

**SÄLJAN worktop**, black marble effect, D63.5 cm.

**Take home today:**

L186×T3.8 cm	203.356.86
L246×T3.8 cm	003.356.87

Custom made:\*

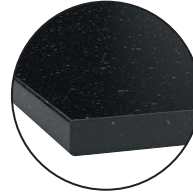
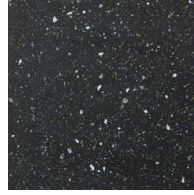

**SÄLJAN worktop**, black mineral effect, D63.5 cm.

**Take home today:**

L186×T3.8 cm	702.022.07
L246×T3.8 cm	702.022.12

Custom made:\*



## Laminate worktops 7.7 cm thick



DEJE laminate worktops are 7.7 cm thick and come with a straight edge. They are durable, easy to maintain, and they come in two finishes: standard and high gloss.

DEJE worktops are available as custom-made for your kitchen solution.

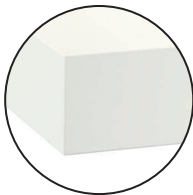
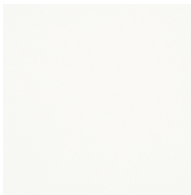

**DEJE worktop**, white.

Custom made:\*

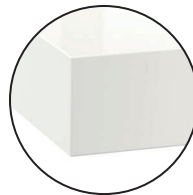
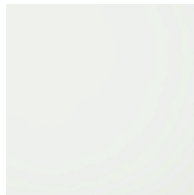

**DEJE worktop**, white high-gloss.

Custom made:\*



## Thick veneer worktops 3.8 and 2.8 cm thick



Natural and hard-wearing, wood brings a warm feeling to your kitchen and makes each worktop unique. With thick veneer worktops, a 3 mm layer of wood covers a particleboard core to add excellent stability.

This construction makes the worktop less sensitive to humidity and much less likely than solid wood to bend, split or crack. Also, with this technique, we can create new unique expressions using less wood, and reducing the impact on the environment.

The worktops are pre-treated with hard wax oil to create an easy-care surface for immediate use. Over time, it will only look better, gaining in character. They can be sanded and treated when needed meaning that they will age gracefully.

Thick veneer worktops come in the following crafted patterns: narrow stave, full plank, butcher-block, fine line and chevron.

Thick veneer worktops are available both as pre-cut (take home today) and custom-made option. Pre-cut worktops can be cut into the exact length you need and finished with the edge strip included in the package.



### Ash

Ash is a blonde hard wood with a beautiful grain pattern. Ash is a tough and strong, yet elastic material with great resilience and finishing properties. It gets gradually darker with age. In its natural form it is heavy and gives a very solid feel.



### Birch

Birch is fine-grained and pale in colour with a satin-like sheen that darkens with age. It often has knots or heartwood in cream or light brown which will give your worktop a unique and distinct natural look.



### Beech

Beech is a hard wood with an even grain. It's durable and often used for furniture and worktops. When exposed to sunlight, beech ages from a light red tone to a more rose-brown colour. Beech characteristics are hardness, strength and good shock resistance.



### Oak

Oak wood is exceedingly strong, heavy and durable. It is an attractive light colour with a prominent grain. Its colour ranges from light brown to a rich reddish-brown and it darkens beautifully with age.



### Walnut

Walnut wood is relatively heavy, hard and resilient. The natural colour light brown to dark chocolate brown adds warmth to your kitchen decor. Walnut gets lighter in colour with age. It has a rich variation in colour and a decorative, curved grain pattern.

**PINNARP worktop, ash.****Take home today:**

L186×T3.8 cm	003.722.98
L246×T3.8 cm	003.723.02

**Custom made:\*****KARLBY worktop, birch.****Take home today:**

L186×T3.8 cm	103.351.87
L246×T3.8 cm	003.351.97

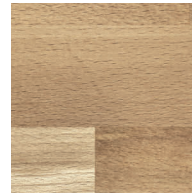
**Custom made:\*****KARLBY worktop, beech.****Take home today:**

L186×T3.8 cm	503.351.85
L246×T3.8 cm	403.351.95

**Custom made:\*****KARLBY worktop, oak.****Take home today:**

L186×T3.8 cm	703.351.89
L246×T3.8 cm	603.351.99

**Custom made:\*****MÖLLEKULLA worktop, oak.****Take home today:**

L186×T3.8 cm	702.992.47
L246×T3.8 cm	502.992.48

**Custom made:\*****SKOGSÅ worktop, oak.****Take home today:**

L186×T3.8 cm	803.829.86
L246×T3.8 cm	003.829.90

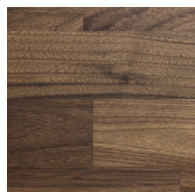
**Custom made:\*****KARLBY worktop, walnut.****Take home today:**

L186×T3.8 cm	303.351.91
L246×T3.8 cm	003.352.01

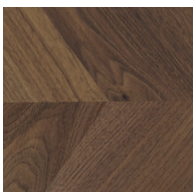
**Custom made:\*****BARKABODA worktop, walnut.****Take home today:**

L186×T3.8 cm	903.314.68
L246×T3.8 cm	503.314.70

**Custom made:\*****PINNARP worktop, walnut.****Take home today:**

L186×T3.8 cm	404.662.28
L246×T3.8 cm	204.662.29

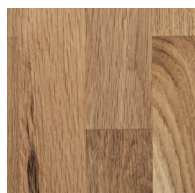
**Custom made:\*****VRENA worktop, oak.****Take home today:**

L186×T2.8cm	004.371.67
L246×T2.8cm	704.371.59

**Custom made:\***

## Quartz worktops 2.0 and 3.0 cm thick



KASKER quartz worktops come in matte or polished finishes, different thicknesses and colours. You can also choose between different edges for an even more personalised expression.

Quartz worktops have a smooth, non-porous surface. This makes them hygienic and resistant to stains and moisture, and they don't require sealing.

As the quartz content is a natural material, you can expect slight variations in colour, and in the size, shape and distribution of particles. These slight variations are part of the beauty and charm of the material and make every worktop unique.

Quartz worktops are available only as custom-made.



**KASKER worktop, white quartz.**

**Custom made:\***

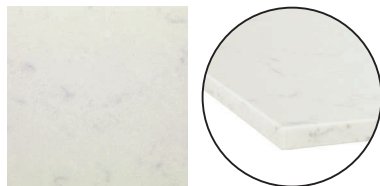

**KASKER worktop, white marble effect/quartz.**

**Custom made:\***



**KASKER worktop, white with mineral/glitter effect/quartz.**

**Custom made:\***



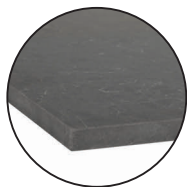
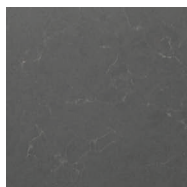

**KASKER worktop**, matt dark grey/marble effect quartz.

*Custom made:\**

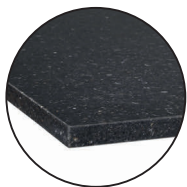
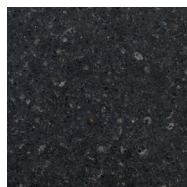

**KASKER worktop**, anthracite mineral effect/quartz.

*Custom made:\**

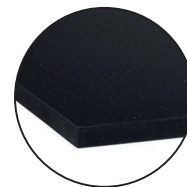
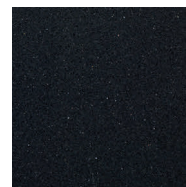

**KASKER worktop**, black stone effect/quartz.

*Custom made:\**

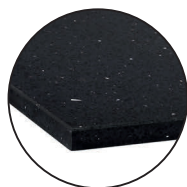
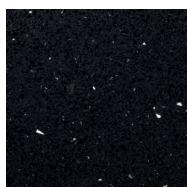

**KASKER worktop**, black with mineral/glitter effect/quartz.

*Custom made:\**

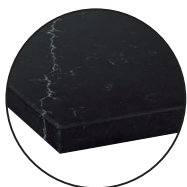
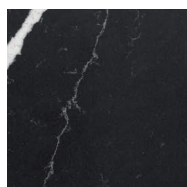

**KASKER worktop**, matt black/marble effect quartz.

*Custom made:\**



### Edge options



Straight



Chamfer

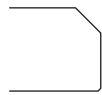

Bevelled



Rounded

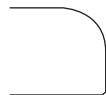

Half-rounded

## Acrylic worktops 4.0 cm thick



LAXNE acrylic worktops offer nearly invisible joints to create a seamless look. You can choose from a variety of colours and different edges for an even more personalised expression.

Acrylic worktops have a smooth and non-porous surface that is resistant to stains and moisture, making them easy to clean. They are made with a thick acrylic top layer on an aluminium under-frame. An extra piece of acrylic has been affixed to the worktop slab to create a thick edge profile.

Acrylic worktops are available only as custom-made.

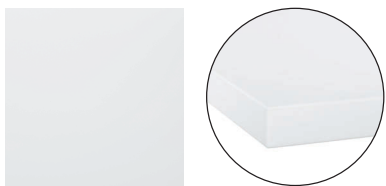

LAXNE custom made worktop, white.

Custom made:\*

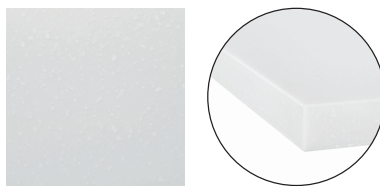

LAXNE custom made worktop, white mineral effect.

Custom made:\*



LAXNE custom made worktop, beige/white mineral effect.

Custom made:\*



LAXNE custom made worktop, light grey mineral effect.

Custom made:\*

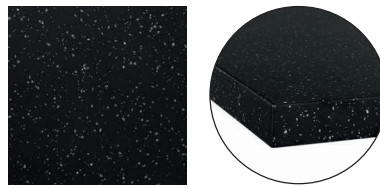

LAXNE custom made worktop, black/grey mineral effect.

Custom made:\*

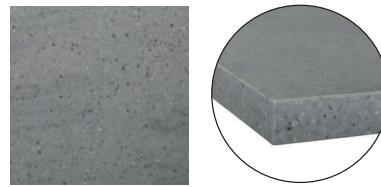

LAXNE custom made worktop, grey with mineral/glitter effect/acrylic.

Custom made:\*



## Edge options



Straight

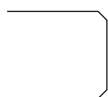

Chamfer



Bevelled

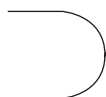

Rounded



Half-rounded



Anti-drip

[Redacted]

[Redacted]

[Redacted]

[Redacted]

[Redacted]

## Worktop accessories

### Bar solution

Make your kitchen the social hub of your home with a bar solution. It gives you more space for working and makes a great place to eat and hang out with family and friends.



**UTBY leg**, stainless steel. UTBY leg gives steady support to your worktop, also on uneven floors.

88 cm	801.175.48
101.5 cm	201.175.51



**CAPITA bracket**, stainless steel, 2-p.  
400.511.96



Create a stylish bar solution and get more work space by mounting it on a worktop. Bar stools with seat height 74 cm fit in well with a bar solution with CAPITA brackets.

### Protection and support for your worktop



**FIXA worktop support fitting**. FIXA worktop support fitting keeps your worktop stable and sturdy after installation.

Galvanised	702.746.28
------------	------------

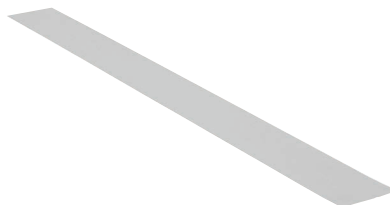

**FIXA diffusion barrier chrome-plated**. Above a dishwasher, FIXA diffusion barrier shall be mounted to the underside of the worktop for added protection against moisture.

Chrome-plated	043.750.85
---------------	------------



**STOCKARYD wood treatment oil**. For indoor use. To ensure that your worktop ages gracefully, treat it regularly with STOCKARYD wood treatment oil; it gives the surface a beautiful sheen, protects the wood and prolongs the life of the worktop.

500 ml	202.404.62
--------	------------

## Finishing touches

Get the most out of your worktop with our worktop accessories and wall edging strips.



**FIXA wall finishing strip**, grey. Fills the gap between the wall and worktop. Fits all IKEA worktops. Can be used with various materials, such as tiles.

205.328.75



**FIXA worktop cover strip**. FIXA cover strip is recommended for straight-edge worktops only. Prevents water from penetrating between worktops.

63.5×1×1.8 cm

303.392.88



**HANSBYN wall edging strip**, 246 cm. Solid wood can be cut to the desired length, sanded and surface treated as needed. Can be used against a tiled wall as well.

Birch	904.890.05
Oak	604.612.77
Walnut	204.890.04



**PINNARP**  
Worktop. Ash,  
186×3.8 cm. 003.722.98

## Big advantages of a custom made worktop

Your custom made worktop is made to fit your kitchen layout perfectly, with the least number of joints. You can order the exact length and depth you need for your kitchen island or bar solution as well as cut-outs for your sink, tap and hob.





Cut-out for hob

Different edges

Custom made  
wall panel

Hole for the tap

# How to buy a custom made worktop and wall panel

---



## 01

---

### Material and colour

There are several colors and materials to choose from. For worktops, choose between laminate, thick veneer, quartz and acrylic. For wall panels, choose between laminate, acrylic, quartz or ceramic.

## 02

---

### The worktop edges

Choose the desired shape and material for the edges. Depending on the material you've chosen for your worktop, you have different options.

## 03

---

### Choose your sink and tap

Choose the sink you want and if you want it top mounted or under-glued.

## 04

---

### Take measurements

Then start to measure to see what size and shape of worktop you need. If you would like help with this, or with anything to do with measuring your kitchen, our measuring service can come to your home.

## 05

---

### We're here to help

To design your custom made worktop and wall panels get help from an IKEA co-worker in the kitchen department at your local store.

## 06

---

### Order

To order your custom made worktop and wall panel, please contact an IKEA co-worker in the kitchen department at your local store.

## How to measure your worktop

Start by measuring your worktop from the corner where it attaches to the wall. Make sure to make your measurements alongside the wall and always start from the same point. When measuring the depth, start from the wall and measure out. Don't forget to add 1.5 cm for an overhang too.

If you need to measure for a freestanding worktop (for a kitchen island for example),

simply start from one end and add 3 cm extra for an overhang.

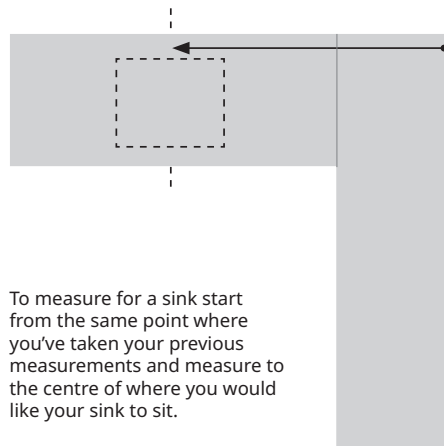
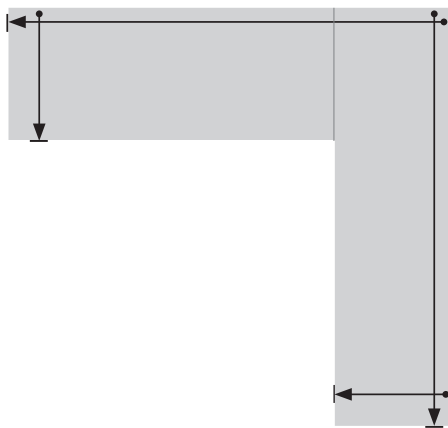

To measure for a sink start from the same point where you've taken your previous measurements and measure to the centre of where you would like your sink to sit.

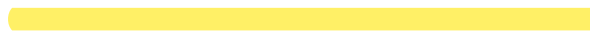

# Wall panels

---

## Walls to match your style!

Adding wall panels is a quick and easy way to update your kitchen with new colors and texture. Our durable and easy-to-clean wall panels protect your walls from splashes and stains when you are cooking. They give you a neat finish where your worktop meets the wall and add a subtle accent of color to your

kitchen walls creating a stylish look. You can choose wall panels in various colors, materials and expressions, some are even double-sided! But if you want to go very personal, you can have your own customized one.

## How to choose your wall panel:

01

---

What's your budget? A stylish look does not have to cost a fortune, our wall panels are available in a wide range of materials and expressions, pre-cut as well as custom-made to perfectly fit your style, needs and wallet.

02

---

What kind of material and expression do you prefer? The material of the wall panel you choose is just as important as the colour. Your wall panel is always going to be right up against your worktop, make sure the two materials and colours work well together.

03

---

Your wall panel has to end up somewhere! Where it ends is up to you – along the length of the wall, up to the bottom of your wall cabinets, up to the ceiling in areas where there are no cabinets (over the sink or over the hob).

**25**

All custom-made wall panels have a 25-year guarantee.



---

## Materials

### Laminate

Laminate wall panels offer a wide variety of colors, patterns and textures needed to personalize your kitchen space. They are resistant to water splashes, stains and grease, which makes them a durable and low maintenance choice.

### Quartz

Quartz wall panels are extremely durable, resistant to scratches, moisture and impacts. They are made by combining ground quartz (one of the hardest materials in nature), resins and pigments. This creates a very hard, non-porous surface that is smooth and come in a wide variety of expressions.

### Acrylic

Acrylic wall panels have a smooth and non-porous surface that is resistant to stains and moisture, making them easy to clean. They're repairable if damage does occur. They're a durable, low maintenance option you can rely on.



## Custom made wall panels

Complement your custom made worktop with a matching wall panel made to perfectly fit your kitchen layout.

Please see **page 108** for more information about custom made options.

### Acrylic Thickness 1.2 cm.

Our acrylic wall panels protect your walls from splashes and grease. The non-porous surface is smooth and easy to keep clean. For perfect color and pattern

match, our acrylic wall panels are made from the same high-quality material as our acrylic worktops.

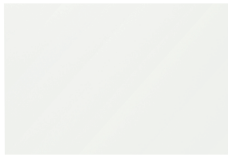

**KLINGSTA custom made wall panel, white.**

*Custom made:\**



**KLINGSTA custom made wall panel, white mineral effect.**

*Custom made:\**



**KLINGSTA custom made wall panel, beige/white mineral effect.**

*Custom made:\**



**KLINGSTA custom made wall panel, light grey mineral effect.**

*Custom made:\**



**KLINGSTA custom made wall panel, grey/black stone effect.**

*Custom made:\**



**KLINGSTA custom made wall panel, dark grey stone effect.**

*Custom made:\**

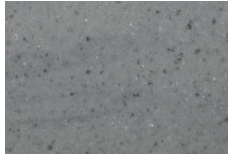

**KLINGSTA custom made wall panel, grey with mineral glitter effect.**

*Custom made:\**



**KLINGSTA custom made wall panel, grey/black mineral effect**

*Custom made:\**



**KLINGSTA custom made wall panel, black/grey mineral effect**

*Custom made:\**



**Quartz** Thickness 1.2 cm.

Our quartz wall panels offer quality of quartz combined with high durability, resistance to stains, scratches and moisture as well as easy maintenance.

For perfect color and pattern match, our quartz wall panels are made from the same high-quality material as our quartz worktops.



**RÄHULT custom made wall panel, white.**  
*Custom made:\**

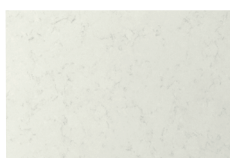

**RÄHULT custom made wall panel, white marble effect.**  
*Custom made:\**



**RÄHULT custom made wall panel, matt white marble effect.**

*Custom made:\**



**RÄHULT custom made wall panel, white mineral effect.**  
*Custom made:\**



**RÄHULT custom made wall panel, white with mineral glitter effect.**

*Custom made:\**

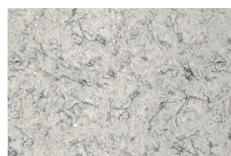

**RÄHULT custom made wall panel, light beige/grey/marble effect.**

*Custom made:\**

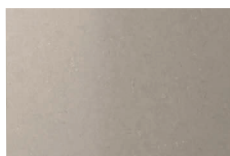

**RÄHULT custom made wall panel, dark beige marble effect.**

*Custom made:\**

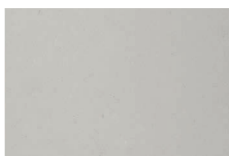

**RÄHULT custom made wall panel, matt light grey/beige/stone effect.**

*Custom made:\**



**RÄHULT custom made wall panel, grey/ brown mineral effect.**

*Custom made:\**

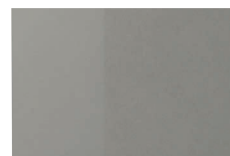

**RÄHULT custom made wall panel, grey stone effect.**

*Custom made:\**



**RÄHULT custom made wall panel, matt concrete effect.**

*Custom made:\**

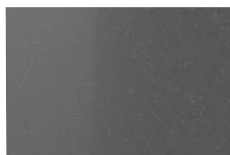

**RÄHULT custom made wall panel, matt dark grey/marble effect.**

*Custom made:\**

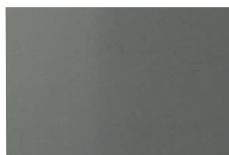

**RÄHULT custom made wall panel, dark grey stone effect.**

*Custom made:\**

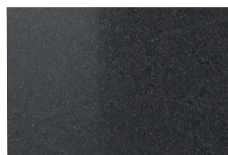

**RÄHULT custom made wall panel, anthracite mineral effect.**

*Custom made:\**



**RÄHULT custom made wall panel, black stone effect.**

*Custom made:\**

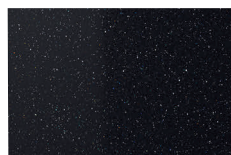

**RÄHULT custom made wall panel, black with mineral glitter effect.**

*Custom made:\**

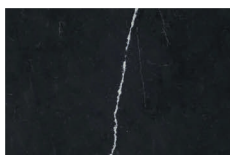

**RÄHULT custom made wall panel, matt black/brown marble effect.**

*Custom made:\**



**Laminate** Thickness 1.3 cm.

Our laminate wall panels are resistant to water splash-  
es, stains and grease, which makes them a durable and  
low maintenance choice. They can be used across the  
kitchen area, except for behind gas hobs. For perfect

color and pattern match, our laminate wall panels are  
made from the same high-quality material as our lami-  
nate worktops.



SIBBARP custom made wall panel, white laminate.

Custom made:\*

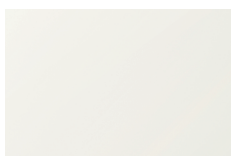

SIBBARP custom made wall panel, off-white laminate.

Custom made:\*



SIBBARP custom made wall panel, white high-gloss laminate.

Custom made:\*



SIBBARP custom made wall panel, white marble effect/laminate.

Custom made:\*

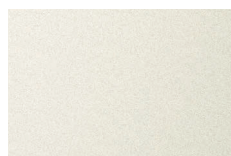

SIBBARP custom made wall panel, white stone effect/laminate.

Custom made:\*

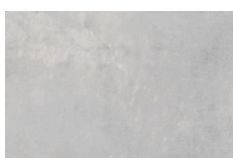

SIBBARP custom made wall panel, light grey concrete effect/laminate.

Custom made:\*

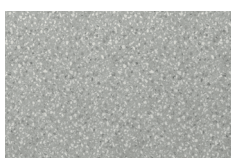

SIBBARP custom made wall panel, light grey/mineral effect laminate.

Custom made:\*



SIBBARP custom made wall panel, light grey laminate.

Custom made:\*



SIBBARP custom made wall panel, light grey stone effect laminate.

Custom made:\*



SIBBARP custom made wall panel, stainless steel effect laminate.

Custom made:\*



SIBBARP custom made wall panel, aluminium effect laminate.

Custom made:\*

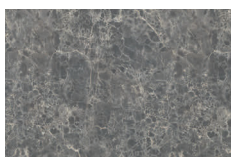

SIBBARP custom made wall panel, dark grey/marble effect laminate.

Custom made:\*



SIBBARP custom made wall panel, matt beige/patterned laminate.

Custom made:\*



**SIBBARP custom made wall panel, matt anthracite**

Custom made:\*



SIBBARP custom made wall panel, ash effect laminate.

Custom made:\*



SIBBARP custom made wall panel, light oak effect laminate.

Custom made:\*

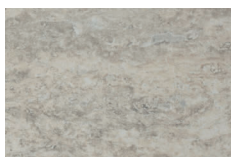

SIBBARP custom made wall panel, oak effect/laminate.

Custom made:\*

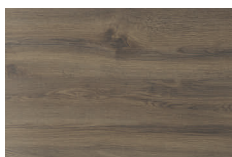

SIBBARP custom made wall panel, dark oak effect laminate.

Custom made:\*

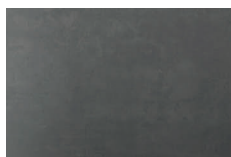

SIBBARP custom made wall panel, concrete effect laminate.

Custom made:\*

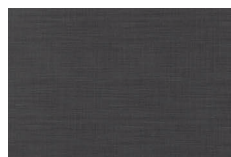

SIBBARP custom made wall panel, dark grey linen effect laminate.

Custom made:\*

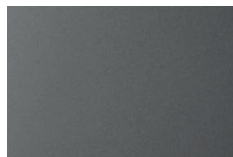

SIBBARP custom made wall panel, black stone effect/laminate.

Custom made:\*

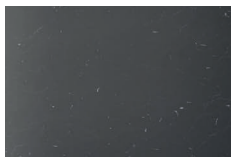

SIBBARP custom made wall panel, black marble effect/laminate.

Custom made:\*

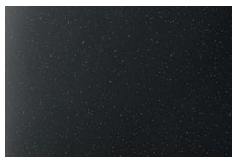

SIBBARP custom made wall panel, black mineral effect/laminate.

Custom made:\*



## Take home today wall panels

Our LYSEKIL wall panels are available to take home today and easy to install. You simply cut them to the right size and put them up on the wall. Follow the included

assembly instructions and it can't go wrong. Combine LYSEKIL wall panels with matching worktops for a perfectly coordinated look.



**LYSEKIL wall panel**, double sided, white/light grey concrete effect.

L119.6×55 cm 803.963.99



**LYSEKIL wall panel**, double sided brass-colour/stainless steel colour.

L119.6×55 cm 203.351.20

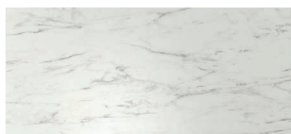

**LYSEKIL wall panel**, double sided white marble effect/black/white mosaic patterned.

L119.6×55 cm 404.644.32

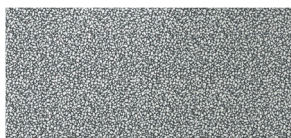

**LYSEKIL rail for wall panel**, aluminum.

L120×55.4 cm 803.351.17



# Sinks

---

## A busy place in the kitchen

The sink and the area around it, is one of the busiest places in the kitchen. You use it for everything from preparing food and rinsing vegetables, to storing dirty dishes and washing up. To make

the activities as easy as possible, choose a sink and sink accessories that match your needs and the way you work in the kitchen.

## How to choose your sink

01

---

How much space have you allocated for the sink? Our sink cabinets are 40, 60 or 80 cm wide.

02

---

Think about how you prepare food, but also how you wash up. Do you have a dishwasher or do you wash the dishes by hand? Do you need one bowl, two bowls or a sink with drainboard?

03

---

Complete your sink with sink accessories that help you organise the area in and around the sink, both when you prepare food and when you wash up.



### Plumbing

Let a professional connect the water to the sink and kitchen mixer tap you've bought from us. Then you know that everything from the U-pipe to water-trap and silicone seals are where they should be – and that costly water leaks will be avoided.

**25**

We test our sinks to ensure they can withstand the demand of everyday life in the kitchen. That's why all our sinks come with a free 25-year guarantee (except FYNDIG).



---

## Our range of sinks

### **Single bowl sinks**

If space is an issue, one single bowl is a good option. Plus, in a big single bowl you can easily wash large pots and pans. Combine with sink accessories to make the bowl as functional as possible

### **Double bowl sinks**

Having two bowls is ideal if you have a lot going on at the same time. For example, if one of the bowls is piling up with dirty dishes, you can still rinse off vegetables and alike in the other.

### **1½ bowl sinks**

A one and a half bowl sink gives you the same advantages as a double bowl sink, but in a smaller area.

### **Sinks with drainboard**

A sink with a drainboard is ideal for drying dishes as the sloping surface make excess water flow back into the bowl. All our sinks with drainboard are reversible, so you can choose if you want the drainboard to the left or to the right.

## Fits 40 cm cabinets



**BOHOLMEN inset sink, 1 bowl**, 47×30 cm. Can be under-glued. May be completed with GRUNDVATTNET sink accessories for effective use of space on the sink.

Stainless steel 991.575.01



**NORRSJÖN inset sink, 1 bowl** 21×44 cm. Can be under-glued. LILLVIKEN lid is included in the price.

Stainless steel 492.503.99



**NORRSJÖN inset sink, 1 bowl**, 37×44 cm. Can be under-glued. LILLVIKEN lid is included in the price. May be completed with NORRSJÖN sink accessories for effective use of space on the sink.

Stainless steel 491.576.50



**KILSVIKEN inset sink, 1 bowl**, 36×46 cm. Can be under-glued. LILLVIKEN lid is included in the price.

Black/quartz composite 693.370.28

## Fits 60 cm cabinets



**HAVSEN inset sink, 1 bowl**, 53×47 cm. May be completed with GRUNDVATTNET sink accessories for effective use of space on the sink. Ceramic.

White 392.537.13



**HAVSEN sink bowl with visible front**, 62×48 cm. May be completed with GRUNDVATTNET sink accessories for effective use of space on the sink. Ceramic.

White 192.537.14



**KILSVIKEN inset sink, 1 bowl**, 56×46 cm. Can be under-glued. LILLVIKEN lid is included in the price.

Black quartz composite 593.370.24



**KILSVIKEN inset sink, 1 bowl**, 56×46 cm. Can be under-glued. LILLVIKEN lid is included in the price.

Grey/beige quartz composite 093.370.26



**KILSVIKEN inset sink, 1 bowl with drainboard**, 72×46 cm. Can be under-glued. LILLVIKEN lid is included in the price. Reversible, so you can use it with the drainboard on the left or right.

Black/quartz composite 893.370.27

## Fits 60 cm cabinets



**HILLESJÖN inset sink, 1 bowl, 56×46 cm.** Can be under-glued. May be completed with GRUNDTVATTNET sink accessories for effective use of space on the sink.

Stainless steel 805.033.99



**FYNDIG inset sink, 1 bowl, 46×40 cm.** May be completed with GRUNDTVATTNET sink accessories for effective use of space on the sink.

Stainless steel 591.580.03



**VATTUDALEN inset sink, 1½ bowl with drainboard, 88×53 cm.** Can be under-glued. Reversible, so you can use it with the drainboard on the left or right. May be completed with GRUNDTVATTNET sink accessories for effective use of space on the sink.

Stainless steel 891.581.91



**NORRSJÖN inset sink, 1 bowl, 54×44 cm.** Can be under-glued. LILLVIKEN lid is included in the price. May be completed with NORRSJÖN sink accessories for effective use of space on the sink.

Stainless steel 491.579.09



**BREDSJÖN sink bowl with visible front, 60×69 cm.** LILLVIKEN lid is included in the price. Require a tap with a minimum reach of 21 cm.

Stainless steel 492.895.56



**HILLESJÖN inset sink, 1½ bowl, 58×46 cm.** Can be under-glued. Reversible, so you can use it with the large bowl on the left or right. May be completed with GRUNDTVATTNET sink accessories for effective use of space on the sink.

Stainless steel 491.406.31



**LÅNGUDDEN inset sink, 1 bowl, 46×46 cm.** Can be under-glued. May be completed with GRUNDTVATTNET sink accessories for effective use of space on the sink.

Stainless steel 591.573.91



**LÅNGUDDEN inset sink, 1 bowl, 56×53 cm.** Can be under-glued. May be completed with GRUNDTVATTNET sink accessories for effective use of space on the sink.

Stainless steel 291.574.77



**AMMERÅN onset sink, 1 bowl, 60×63,5 cm.** With the same depth and edge thickness, this sink fits perfectly between two separate 2.8 cm thick worktop pieces. May be completed with GRUNDTVATTNET sink accessories for effective use of space on the sink.

Stainless steel 591.581.64



**BOHOLMEN inset sink, 1 bowl, 45×15 cm.** Can be under-glued.

Stainless steel 791.574.94



**VATTUDALEN inset sink, 1 bowl with drainboard, 69×47 cm.** Can be under-glued. Reversible, so you can use it with the drainboard on the left or right. May be completed with GRUNDTVATTNET sink accessories for effective use of space on the sink.

Stainless steel 691.581.68



**VATTUDALEN inset sink, 1 bowl with drainboard, 86×47 cm.** Can be under-glued. Reversible, so you can use it with the drainboard on the left or right. May be completed with GRUNDTVATTNET sink accessories for effective use of space on the sink.

Stainless steel 291.581.89

## Fits 80 cm cabinet



**HAVSEN sink bowl with visible front, 2 bowls, 82×48 cm.** May be completed with GRUNDVATTNET sink accessories for effective use of space on the sink.

White 792.502.65



**HILLESJÖN inset sink, 1½ bowl, 75×46 cm.** Can be under-glued. Reversible, so you can use it with the large bowl on the left or right. May be completed with GRUNDVATTNET sink accessories for effective use of space on the sink.

Stainless steel 291.711.38



**KILSVIKEN inset sink, 1 bowl, 72×46 cm.** Can be under-glued. LILLVIKEN lid is included in the price.

Black/quartz composite 293.370.25



**LÅNGUDDEN inset sink, 2 bowls, 75×53 cm.** Can be completed with GRUNDVATTNET sink accessories for effective use of space on the sink.

Stainless steel 191.574.87



**VATTUDALEN inset sink, 2 bowls with drainboard, 110×53 cm.** Can be under-glued. Reversible, so you can use it with the drainboard on the left or right. May be completed with GRUNDVATTNET sink accessories for effective use of space on the sink.

Stainless steel 091.581.90



**BREDSJÖN sink bowl, 2 bowls with visible front, 80×69 cm.** LILLVIKEN lid is included in the price. Require a tap with a minimum reach of 21 cm.

Stainless steel 592.895.46



**NORRSJÖN inset sink, 1 bowl, 73×44 cm.** Can be under-glued. LILLVIKEN lid is included in the price. May be completed with NORRSJÖN sink accessories for effective use of space on the sink.

Stainless steel 191.579.15



**NORRSJÖN inset sink, 2 bowls, 73×44 cm.** Can be under-glued. LILLVIKEN lid is included in the price. May be completed with NORRSJÖN sink accessories for effective use of space on the sink.

Stainless steel 391.579.19



**LILLVIKEN lid.** Attaches via a magnet to all sink bowls with LILLVIKEN water-trap and can be used as a handle for lifting the basket. The lid creates a flat surface at the bottom of the sink and prevents food waste from getting into the basket, making the sink easy to keep clean.

203.178.52

## Water traps



**LILLVIKEN water trap/strainer 1 bowl.** Water trap with connection for dishwasher or washing machine. Polypropylene plastic.

103.115.39



**LILLVIKEN water trap/strainer 2 bowls.** Water trap with connection for both dishwasher and washing machine. Polypropylene plastic.

903.115.40



**LILLVIKEN extra connection for water-trap.** Allows you to connect an extra appliance to LILLVIKEN water-trap. Polypropylene plastic.

403.883.15

# Under-glued sinks

---

Under-glued sinks give you an uninterrupted, smooth look. They make cleaning your worktop easy, as there are no obstructions for food scraps to catch on. You can order an under-

glued sink when you order a custom made worktop. They are fitted in the factory, leaving the work up to us.

## Under-glued in quartz worktop



## Under-glued in acrylic worktop



## Under-glued in laminate worktop



**Under-glued in thick veneer worktop**



**Under-glued in solid wood worktop**



# Kitchen taps

---

## Saving water at every step

Earth may be covered in a lot of water, but very little of it is drinkable and even less is accessible. No organism can survive without it, and no new water is created. It's constantly recycled, but our freshwater supply is overused; not evenly distributed; and impacted by pollution, contamination and climate change. That's why we equip all our

kitchen mixer taps with a water saving aerator that reduces water use – while maintaining the same water stream. We didn't invent aerators, but think they are an important example of how we can work together to save water for everyone's benefit.



### Plumbing

Let a professional connect the water to the sink and kitchen mixer tap you've bought from us. Then you know that everything from the U-pipe to water-trap and silicone seals are where they should be – and that costly water leaks will be avoided.

**10**

All our kitchen mixer taps are tested and third party certified to meet, or exceed, the demands of the relevant national and international mechanical, quality, safety and hygienic standards. All IKEA kitchen mixer taps come with a free 10-year guarantee.



# Functions



## Kitchen mixer taps with low spout

Kitchen mixer taps with low spouts always have the handle on top, and are ideal for small single bowl sinks.

YTTRAN kitchen mixer tap\*



## Kitchen mixer taps with high spout

The high spout makes it easier to wash dishes, including large pots.

INSJÖN kitchen mixer tap\*



## Kitchen mixer taps with pull-out spout

Rinsing dishes is easier with the pull-out spout. A counterweight makes the hose easily retract back into the kitchen mixer tap.

ÄLMAREN kitchen mixer tap with pull-out spout\*



## Kitchen mixer taps with handspray

The tap functions two ways, so you can switch between a concentrated stream and a shower function.

TOLLSJÖN kitchen mixer tap/handspray \*



### Kitchen mixer taps with sensor

The kitchen mixer tap's sensor function is simple, hygienic and practical – perfect when you just want to fill a glass with water or rinse off your hands when cooking.

TÄMNAREN kitchen mixer tap with sensor\*

## Kitchen mixer taps



**LAGAN kitchen mixer tap** H16 cm.  
Swivel spout: 360°.  
Chrome-plated 900.850.28



**GLYPEN mixer tap** H26 cm. Swivel spout is preset to 360° but can be changed to 90° or 120°.  
Stainless steel colour 304.423.89



**YTTRAN kitchen mixer tap** H19 cm.  
Swivel spout is preset to 360° but can be changed to 120°. Also available with pull-out spout.  
Chrome-plated 803.059.45



**BOSJÖN kitchen mixer tap** H32 cm.  
Swivel spout: 120°.  
Stainless steel colour 604.573.98  
Brushed black metal 804.584.53



**EDSVIK dual-control kitchen mixer tap** H30 cm. Swivel spout: 360°.  
Chrome-plated 800.318.42



**GLITTRAN kitchen mixer tap** H28 cm.  
Swivel spout: 360°.  
Chrome-plated 702.226.20  
Black 204.686.81  
Brass-colour 502.256.10

## Kitchen mixer taps with pull-out spout



**ÄLMAREN kitchen mixer tap with pull-out spout** H36 cm. Swivel spout 120°. Also available without pull-out spout.

Stainless steel  
colour 204.280.58



**INSJÖN kitchen mixer tap with pull-out spout** H43 cm. Swivel spout: 120°. Also available without pull-out spout, or with sensor function.

Chrome-plated 203.418.71

## Kitchen mixer taps with high spout



**NYVATTNET kitchen mixer tap** H40 cm. Swivel spout is preset to 360° but can be changed to 120°.

Chrome-plated 304.896.35



**ÄLMAREN kitchen mixer tap** H36 cm. Swivel spout is preset to 360° but can be changed to 120°. Also available with pull-out spout.

Stainless steel  
colour 604.551.63  
Chrome-plated 204.551.60



**GAMLESJÖN dual-control kitchen mixer tap** H36 cm. Swivel spout 360°.

Brushed black  
metal 303.416.77



**INSJÖN kitchen mixer tap** H40 cm. Swivel spout is preset to 360° but can be changed to 120°. Also available with pull-out spout or sensor function.

Chrome-plated 603.701.21



**DELSJÖN kitchen mixer tap** H36 cm. Swivel spout is preset to 360° but can be changed to 120°.

Pewter effect 304.887.87  
Brass colour 404.780.47

## Kitchen mixer taps with handspray



**VIMMERN kitchen mixer tap with handspray** H47 cm. Swivel spout: 360°.

Stainless steel  
colour 403.070.17



**TOLLSJÖN kitchen mixer tap with handspray** H46 cm. Swivel spout is preset to 360° but can be changed to 120°.

Black polished  
metal 803.416.89  
Chrome-plated 903.416.98



**TÄMNAREN kitchen mixer tap with sensor** H31 cm. Swivel spout is preset to 360° but can be changed to 120°.

Stainless steel  
colour 003.595.03



**INSJÖN kitchen mixer tap with sensor**, H40 cm. Swivel spout is preset to 360° but can be changed to 120°. Also available without sensor function or with pull-out spout.

Chrome-plated 603.419.06



**KNIPEN detergent dispenser**, 5 dl. Mounts in the sink or worktop so you always have washing up liquid close at hand. The washing-up detergent can be refilled from above.

Stainless steel

703.417.22



**FIXA 2-piece tool set**. Makes it easy to cut out a hole for a mixer tap in a stainless steel sink unit. Can also be used to cut copper pipes.

285.121.00



# Kitchen organisers

---

## A kitchen easy to live in

Your kitchen isn't fully in function until everything in it has found a place of its own. With smart organisers and acces-

sories, you'll find what you need, when you need it.

## Your best kitchen friends

Trays, boxes and waste organisers help you to make the most of the space inside your kitchen cabinets.

flow both when preparing food and washing up.

The sink area is a busy place. We have accessories with multiple purposes that can help you utilise the area in and around the sink, supporting the work-

Utilise the full area in the kitchen, even the walls. With smart wall storage often used items can be close at hand, at the same time you free up workspace.



## Create the perfect combination for your drawers

Less time searching, more time for cooking. Clever inside trays for your drawers keep cutlery and kitchen utensils organised and in place. To really make sure you

can see everything in the drawer, complete with kitchen lighting.

### 40 cm drawer

Inner dimensions 32 cm

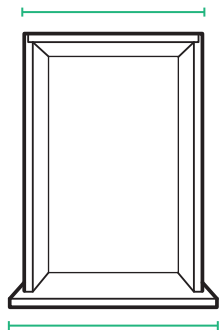

Outer dimensions 40 cm



06 1× UPPDATERA Cutlery tray, 32×50 cm



02 1× UPPDATERA Utensil tray, 20×50 cm  
10 1× UPPDATERA Spice rack  
03 1× UPPDATERA Adjustable add-on tray, 25×50 cm



02 2× UPPDATERA Utensil tray, 20×50 cm  
11 1× UPPDATERA Knife rack  
10 1× UPPDATERA Spice rack



08 1× UPPDATERA Cutlery tray, 32×50 cm

### 60 cm drawer

Inner dimensions 52 cm

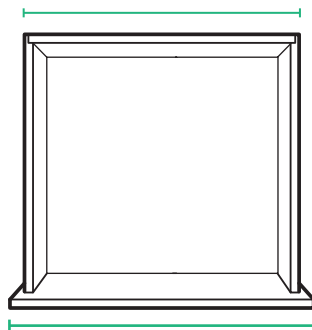

Outer dimensions 60 cm



06 1× UPPDATERA Cutlery tray, 32×50 cm  
02 1× UPPDATERA Utensil tray, 20×50 cm



06 1× UPPDATERA Cutlery tray, 32×50 cm  
02 1× UPPDATERA Utensil tray, 20×50 cm  
10 1× UPPDATERA Spice rack



09 1× UPPDATERA Cutlery tray, 52×50 cm



08 1× UPPDATERA Cutlery tray, 32×50 cm  
05 1× UPPDATERA Utensil tray, 20×50 cm  
11 1× UPPDATERA Knife rack

### 80 cm drawer

Inner dimensions 72 cm

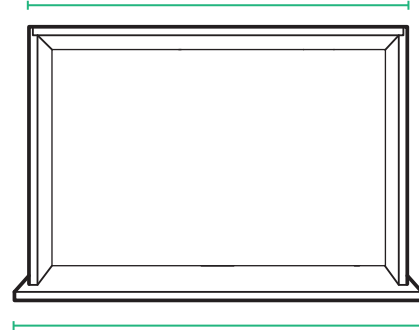

Outer dimensions 80 cm



06 1× UPPDATERA Cutlery tray, 32×50 cm  
02 2× UPPDATERA Utensil tray, 20×50 cm



06 1× UPPDATERA Cutlery tray, 32×50 cm  
02 2× UPPDATERA Utensil tray, 20×50 cm  
10 1× UPPDATERA Spice rack  
11 1× UPPDATERA Knife rack



09 1× UPPDATERA Cutlery tray, 52×50 cm  
05 1× UPPDATERA Utensil tray, 20×50 cm



09 1× UPPDATERA Cutlery tray, 52×50 cm  
05 1× UPPDATERA Utensil tray, 20×50 cm  
11 1× UPPDATERA Knife rack

## UPPDATERA interior fittings

Choose interior fittings that suit your size of drawer and your cutlery and utensils. A helpful tip is to keep

things close to where they are used as this enables a smooth workflow.

### Utensil trays

01



UPPDATERA Utensil tray, 20×31 cm.  
White 104.600.15

02



UPPDATERA Utensil tray, 20×50 cm.  
White 504.600.18

03



UPPDATERA adjustable add-on tray, 25×50 cm.  
White 704.888.46

04



UPPDATERA utensil tray, 10×50 cm.  
Light bamboo 004.883.26

05



UPPDATERA Utensil tray, 20×50 cm.  
Light bamboo 704.599.76

### Cutlery trays

06



UPPDATERA Cutlery tray, 32×50 cm.  
White 104.600.20

07



UPPDATERA Cutlery tray, 32×31 cm.  
White 704.600.17

08



UPPDATERA Cutlery tray, 32×50 cm.  
Light bamboo 404.599.73

09



UPPDATERA Cutlery tray, 52×50 cm.  
Light bamboo 704.331.04

### Spice and knife rack inserts

10

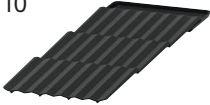

UPPDATERA Spice rack.  
Anthracite 304.599.78

11



UPPDATERA Knife rack.  
Anthracite 804.332.07

### Pegboard drawer organiser

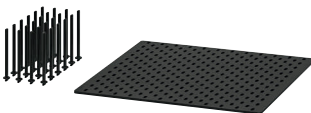

UPPDATERA Pegboard drawer organiser.  
Anthracite.  
60 cm 604.600.08

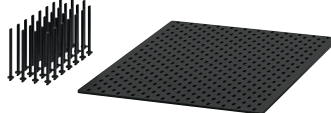

UPPDATERA Pegboard drawer organiser.  
Anthracite.  
80 cm 004.600.11

## Waste sorting combinations

Are you curious about how your waste can become new resources? HÅLLBAR series helps you sort different materials into different bins – a simple action and the first step towards giving waste a new life. HÅLLBAR

waste sorting management series is a waste management solution for any room of your home and can be built-in and freestanding, whichever you prefer.



The bin's ventilation holes and the form of the bottom allow the air to circulate and dry out the organic waste. This minimises unwanted odours.



A ring on the top edge of the bin hides the waste bag and keeps it in place. It's removable either for easy cleaning or if not being used



The folding handle makes it easy to carry the bin with you to the waste station.



The included sticker can be attached to the bin to mark what you are sorting. Draw or write on the sticker to make it clear what goes in the bin.

## MAXIMERA high drawer, 60 cm wide, 45 cm deep

HÅLLBAR bin with lids are designed to meet different waste sorting needs. This narrow combination is suitable if you have limited space and choose to sort your waste at the recycling station.



**HÅLLBAR waste sorting solution 42L for METOD kitchen drawer, ventilated/light grey.** A combination with 1 bin for sorting your cans and smaller packages, 1 for cartons, plastic, bottles, jars and advertising mail, and 1 for dry and wet organic waste.  
(293.088.29)



**HÅLLBAR waste sorting solution 44 l for METOD kitchen drawer/light grey.** A combination with 2 bins for sorting your cartons, plastic, paper, bottles, glass, jars, envelopes and advertising mail.  
(193.088.39)



**HÅLLBAR waste sorting solution 40L for METOD kitchen drawer, ventilated/light grey.** A combination with 3 bins for sorting your cans and smaller packages such as hygiene products, and 1 for sorting dry and wet organic waste.  
(393.089.23)

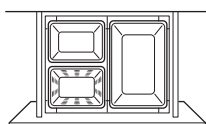

### Parts included in this solution

HÅLLBAR bin with lid, 10L, light grey	803.980.58	1 pc
HÅLLBAR bin with lid, 22L, light grey	204.202.03	1 pc
HÅLLBAR bin with lid for organic waste, 10L, light grey	804.338.82	1 pc
HÅLLBAR support frame for waste sorting bins, 60 cm, white	804.228.69	1 pc

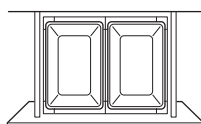

### Parts included in this solution

HÅLLBAR bin with lid, 22L, light grey	204.202.03	2 pcs
HÅLLBAR support frame for waste sorting bins, 60 cm, white	804.228.69	1 pc

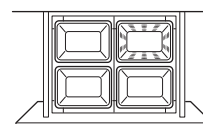

### Parts included in this solution

HÅLLBAR bin with lid, 10L, light grey	803.980.58	3 pcs
HÅLLBAR bin with lid for organic waste, 10L, light grey	804.338.82	1 pc
HÅLLBAR support frame for waste sorting bins, 60 cm, white	804.228.69	1 pc

## MAXIMERA high drawer 80 cm wide, 45 cm deep

HÅLLBAR bin with lids are designed to meet different waste sorting needs. This combination is suitable if you want to make it easy to sort your waste at home.



**HÅLLBAR waste sorting solution 55L for METOD kitchen drawer ventilated/light grey.** A combination with 4 bins for sorting everything from cartons, bottles and cans to smaller packages, lightbulbs and batteries, and 1 for sorting dry and wet organic waste.  
(693.089.26)



**HÅLLBAR waste sorting solution 57L for METOD kitchen drawer/light grey.** A combination with 4 bins for sorting everything from cartons, bottles, cans and smaller packages to lightbulbs and batteries.  
(993.096.94)



**HÅLLBAR waste sorting solution 53L for METOD kitchen drawer ventilated/light grey.** A combination with 5 bins for sorting everything from cans and smaller packages to lightbulbs and batteries, and 1 for sorting dry and wet organic waste.  
(093.096.98)

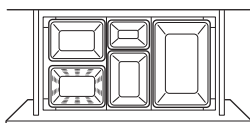

### Parts included in this solution

HÅLLBAR bin with lid with lid, 10L, light grey	803.980.58	2 pcs
HÅLLBAR bin with lid, 22L, light grey	204.202.03	1 pc
HÅLLBAR bin with lid, 3L, light grey	904.321.94	1 pc
HÅLLBAR bin with lid for organic waste, 10L, light grey	804.338.82	1 pc
HÅLLBAR support frame for waste sorting bins, 80 cm, white	604.228.70	1 pc

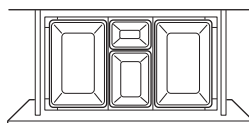

### Parts included in this solution

HÅLLBAR bin with lid, 10L, light grey	803.980.58	1 pc
HÅLLBAR bin with lid 22L, light grey	204.202.03	2 pcs
HÅLLBAR bin with lid 3L, light grey	904.321.94	1 pc
HÅLLBAR support frame for waste sorting bins, 80 cm, white	604.228.70	1 pc

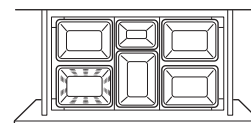

### Parts included in this solution

HÅLLBAR bin with lid 10L, light grey	803.980.58	4 pcs
HÅLLBAR bin with lid 3L, light grey	904.321.94	1 pc
HÅLLBAR bin with lid for organic waste, 10L, light grey	804.338.82	1 pc
HÅLLBAR support frame for waste sorting bins, 80 cm, white	604.228.70	1 pc

## Waste sorting combinations

### HÅLLBAR pull-out solutions

HÅLLBAR bin with lids are designed to meet different waste sorting needs. This narrow combination is suitable if you have limited space and choose to sort your waste at the recycling station.



**HÅLLBAR waste sorting solution 20L with pull-out/light grey.** A combination with 2 bins that is perfect for sorting your tin cans and smaller packages. (793.088.03)



**HÅLLBAR waste sorting solution 20L with pull-out ventilated/light grey.** A combination with 1 bin for sorting your tin cans and smaller packages and 1 for dry and wet organic waste. (993.088.16)



**HÅLLBAR waste sorting solution 22L with pull-out/light grey.** HÅLLBAR bin with lids are designed to meet different waste sorting needs. This bin is perfect for sorting things like cardboard, plastic, paper, bottles, glass, tin cans, envelopes and advertising mail. (093.088.25)

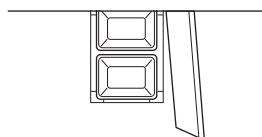

#### Parts included in this solution

HÅLLBAR bin with lid, 10L, light grey	803.980.58	2 pcs
HÅLLBAR pull-out frame for waste sorting, light grey	204.228.53	1 pc

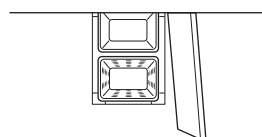

#### Parts included in this solution

HÅLLBAR bin with lid for organic waste 10L, light grey	804.338.82	1 pc
HÅLLBAR bin with lid 10L, light grey	803.980.58	1 pc
HÅLLBAR pull-out frame waste sorting light grey	204.228.53	1 pc

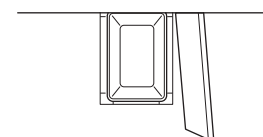

#### Parts included in this solution

HÅLLBAR bin with lid 22L, light grey	204.202.03	1 pc
HÅLLBAR pull-out frame waste sorting, light grey	204.228.53	1 pc



HÅLLBAR bin with lids are stackable to save space. Place same-size bins on top of each other or place smaller bins on top of the larger ones.



Mount this pull-out frame inside your cabinet to hide your waste sorting behind a door. Easy to mount and use in cabinets throughout the home. Pull-out to sort and push it back when you are done.

## HÅLLBAR Freestanding waste sorting solutions

The bins can be placed freestanding anywhere in your home or integrated in a cabinet or drawer.

HÅLLBAR bin with lids are stackable to save space. Place same-size bins on top of each other or place smaller bins on top of the larger ones.

A lid is included to hide your waste. It's removable for easy cleaning or if you prefer to keep your bin open.



**HÅLLBAR bin with lid, 3L, light grey.** This bin is perfect for sorting used batteries and light bulbs, or to store smaller items like sponges, cloths, tea lights and crayons.

904.321.94



**HÅLLBAR bin with lid, 10L, light grey.** This bin is perfect for sorting tin cans, small packages such as hygiene products or to store paper rolls or shopping bags.

803.980.58



**HÅLLBAR bin with lid for organic waste, 10L, light grey.** This bin is perfect for sorting dry and wet organic waste such as coffee grounds and peels from fruits or vegetables. The bin's ventilation holes and the form of the bottom allow the air to circulate and dry out the organic waste. This minimises unwanted odours.

804.338.82



**HÅLLBAR bin with lid, 22L, light grey.** This bin is perfect for sorting things like cardboard, plastic, paper, bottles, glass, tin cans, envelopes and advertising mail.

204.202.03



**HÅLLBAR bin with lid, 35L, light grey.** This bin is perfect for sorting things like cartons, bottles and newspapers or to give bulkier items their own space.

504.202.06



**HÅLLBAR pull-out frame for waste sorting, light grey.** Mount this pull-out frame inside your cabinet to hide your waste sorting behind a door. Easy to mount and use in cabinets throughout the home. The pull-out frame gives you quick access and a good overview of your waste sorting and keeps your bin stable. Pull it out to sort and push it back when you are done.

204.228.53



**HÅLLBAR support frame for waste sorting bins, W60 cm, white.** By mounting HÅLLBAR support frame for waste sorting bins in MAXIMERA high drawer you can hide your waste sorting. The support frame provides quick access and a good overview of your waste sorting and keeps your bins stable. Pull it out to sort and push it in when you are done.

Mount in MAXIMERA high drawer 60×60 cm or in MAXIMERA high drawer 60×45 cm to allow space for pipes behind the drawer. Dimensioned for HÅLLBAR bin with lids, excluding 3 l and 35L bins.

804.228.69



**HÅLLBAR support frame for waste sorting bins, W80 cm, white.** By mounting HÅLLBAR support frame for waste sorting bins in MAXIMERA high drawer you can hide your waste sorting. The support frame provides quick access and a good overview of your waste sorting and keeps your bins stable. Pull it out to sort and push it in when you are done.

Mount in MAXIMERA high drawer 80×60 cm or in MAXIMERA high drawer 80×45 cm to allow space for pipes the drawer. Dimensioned for HÅLLBAR bin with lids, excluding the 35L bin.

604.228.70

## Other freestanding waste sorting products



**SORTERA waste sorting bin/lid, white.**

37 l 102.558.97

60 l 702.558.99



**GIGANTISK touch top bin, dark grey.**

60 l 203.140.71



**MJÖSA pedal bin, dark grey.**

12 l 104.228.44

30 l 004.228.54



**KNODD bin/lid, grey.**

16 l 603.122.49

40 l 903.153.12

# Knobs and handles

---

## Small details that makes a difference!

Knobs and handles are like icing on the cake. Enhance the style you like, refresh the look of doors and drawers, co-ordinate with the rest of your home – or simply change because it's fun.

Knobs and handles may seem small but they can help you to really personalise your kitchen. You can enhance a style to make your kitchen look more traditional or more modern. Mix them or match them perfectly and play with placements to create the finishing touches to the look you want in your dream kitchen.



### **FIXA drill template**

This simple tool helps you easily and accurately mark where you want to place your knobs and handles. Available online and at your local IKEA store.



## Knobs and handles

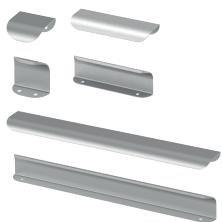

**BILLSBRO handle, stainless steel colour.**

L40 mm	603.235.92
L120 mm	703.236.00
L320 mm	503.235.97
L520 mm	403.235.93
L720 mm	703.235.96



**BILLSBRO handle, white.**

L40 mm	203.343.14
L120 mm	503.343.03
L320 mm	603.343.12
L520 mm	503.343.17
L720 mm	103.343.19

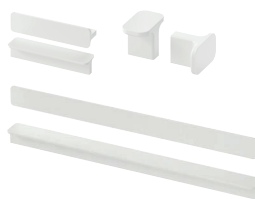

**HACKÁS handle, white.**

L100 mm	304.086.82
L300 mm	104.086.83

**HACKÁS knob, white.**

Ø15 mm	604.086.85
--------	------------

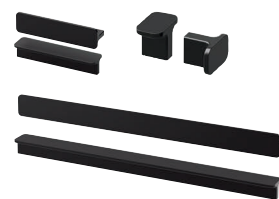

**HACKÁS handle, anthracite.**

L100 mm	303.424.79
L300 mm	503.424.78

**HACKÁS knob, anthracite.**

Ø15 mm	803.397.90
--------	------------



**BAGGANÄS handle, black.**

L143 mm	803.384.13
L335 mm	603.384.14



**BAGGANÄS handle, brass-colour.**

L143 mm	003.384.07
L335 mm	203.384.11



**BAGGANÄS handle, stainless steel.**

L143 mm	703.384.18
L335 mm	503.384.19



**KLACKBERG knob, silver-colour.**

Ø35 mm	303.731.64
--------	------------



**BAGGANÄS knob, black.**

Ø13 mm	303.384.15
Ø20 mm	103.384.16
Ø21 mm	903.384.17



**BAGGANÄS knob, brass-colour.**

Ø13 mm	603.384.09
Ø20 mm	803.384.08
Ø21 mm	003.384.12



**BAGGANÄS knob, stainless steel.**

Ø13 mm	303.384.20
Ø20 mm	103.384.21
Ø21 mm	903.384.22



**GUBBARP handle, white.**

L116 mm	003.364.32
---------	------------

**GUBBARP knob, white.**

Ø21 mm	803.364.33
--------	------------

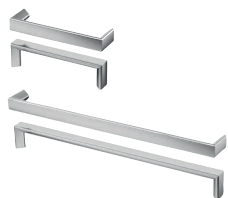

**TYDA handle, stainless steel.**

L138 mm	701.169.31
L330 mm	501.139.19



**ORRNÄS handle, stainless steel colour.**

L170 mm	702.361.51
L234 mm	802.254.11
L300 mm	402.254.13

**ORRNÄS knob, stainless steel colour.**

Ø17 mm	302.361.53
--------	------------



**SÖRBYN handle, stainless steel.**

96 mm	904.503.38
-------	------------

**SÖRBYN knob, stainless steel.**

Ø25 mm	504.503.40
--------	------------



**KALLRÖR handle, stainless steel.**

L213 mm	503.570.02
---------	------------

L405 mm	103.570.04
---------	------------

L597 mm	303.570.03
---------	------------

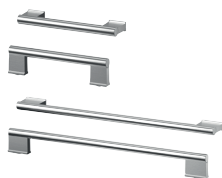

**VINNA handle, stainless steel.**

L153 mm	201.166.98
L357 mm	001.166.99

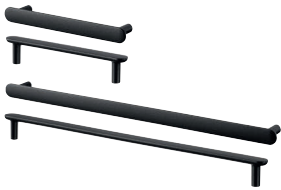
**NYDALA handle, black.**

L154 mm 004.496.36  
L346 mm 404.496.39

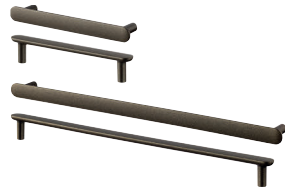
**NYDALA handle, bronze-colour.**

L154 mm 204.057.59  
L346 mm 604.057.57

**ÖSTERNÄS handle, tanned leather.**

L153 mm 403.488.95  
L65 mm 203.488.96

**VINNÄSET knob.**

Ø37 mm 504.342.94

**NYDALA knob, black.**

Ø16 mm 804.496.42

**NYDALA knob, bronze-colour.**

Ø16 mm 404.057.58

**ENERYDA cup handle, brass-colour.**

L89 mm 903.475.15

**MOSSARYD drop handle.**  
Black

L49 mm 503.703.53

Stainless steel colour

L49 mm 703.703.52

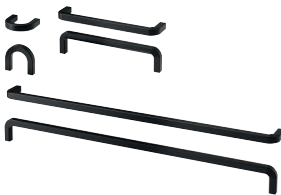
**BORGHAMN handle, steel.**

L40 mm 003.160.47  
L170 mm 203.160.46  
L426 mm 403.189.78

**HISHULT handle, porcelain white.**

L140 mm 902.652.46

**HISHULT knob, porcelain white.**

Ø23 mm 202.731.41  
Ø30 mm 502.652.48

**ENERYDA handle, brass-colour.**

L112 mm 203.475.14

**MÖLLARP handle, black.**

L106 mm 702.652.47

**MÖLLARP knob, black.**

Ø14 mm 102.730.90

**SKÄRHAMN handle, black/chrome-plated.**

L148 mm 503.487.86

**SKÄRHAMN knob, black/chrome-plated.**

Ø22 mm 703.487.85  
Ø30 mm 303.710.56

**SKÄRHAMN drop handle, black/chrome-plated.**

L65 mm 103.694.36

**ENERYDA cup handle, chrome-plated.**

L89 mm 403.475.13

**ENERYDA knob, black.**

Ø20 mm 303.475.04  
Ø27 mm 803.475.06  
Ø35 mm 003.475.05

**ENERYDA knob, brass-colour.**

Ø20 mm 203.475.09  
Ø27 mm 403.475.08  
Ø35 mm 603.475.07

**ENERYDA knob, chrome-plated.**

Ø20 mm 503.475.03  
Ø27 mm 003.475.10  
Ø35 mm 803.475.11

**ENERYDA handle, chrome-plated.**

L112 mm 603.475.12

**ENERYDA cup handle, black.**

L89 mm 503.475.17

**ENERYDA handle, black.**

L112 mm 703.475.16

# Kitchen accessories

---

Whether you have a new, beautifully-planned kitchen or just looking to make improvements in your current one - there are a few secret ingredients that will make life simpler and more enjoyable. For instance, smart organisers create natural spots for storing cooking utensils and gadgets, so the whole family knows where to find them - and where to put them back. Trays, boxes and waste organisers work double

shift by preventing clutter and making the best use of space inside your cabinets and drawers. Wall storage does its magic by putting all those things you use the most, close at hand - right where you need them. And for the busiest place in the kitchen - don't forget the clever accessories around the sink that come in handy when preparing food and washing up.



## Kitchen islands, sideboards, trolleys and step stools

All of these are easy additions to any kitchen design. A kitchen island serves as an extended worktop space and often becomes a favourite spot for snacking, working and socialising. Sideboards add that little extra storage we all need and a trolley on wheels offers roll-anywhere convenience. A step-stool is a must-have for any kitchen, for reaching things up high, letting kids join the fun at the worktop, or using as extra seating by the table.



## Having things in plain sight has its advantages

With open shelves, hooks, rails and racks you can create a personal combination that gives a good overview of your kitchen and makes everything easily accessible. Inspired by restaurant kitchens, we created KUNGSFORS series of wall-mounted shelves and accessories so you can feel like a professional and enjoy a smooth workflow.



## Wall storage



**KUNGSFORS shelf\***, W60×D30 cm.

Ash veneer	903.712.23
Stainless steel	503.349.25
Bamboo	004.017.81



**KUNGSFORS suspension rail\***, L80 cm.

Stainless steel	803.348.58
-----------------	------------



**KUNGSFORS wall grid\***, W56×H26.5 cm.

Stainless steel	803.349.19
-----------------	------------



**KUNGSFORS dish drainer\***, W60×D30×H10 cm.

Powder coated steel/ stainless steel	403.712.25
---	------------



**KUNGSFORS suspension rail with shelf/wall grid\***, W184×D32×H160 cm.

Stainless steel/ ash veneer	292.543.41
--------------------------------	------------



**KUNGSFORS suspension rail/shelf/dish drainer/  
rail/wall grid\***, W184×D32×H80 cm.

Ash veneer/stainless steel/powder coated steel	892.543.38
---	------------



**KUNGSFORS suspension rail with shelf/rail/wall  
grid/ash veneer shelf\***, W184×D32×H80 cm.

Stainless steel/ ash veneer	592.848.79
--------------------------------	------------



**KUNGSFORS suspension rail/shelf/dish drainer/  
wall grid\***, W124×D32×H102 cm.

Ash veneer/stainless steel/powder coated steel	492.543.35
---	------------



**KUNGSFORS suspension rail with shelf/mag-  
net knife rack/wall grid/ash veneer shelf\***,  
W124×D32×H120 cm.

Stainless steel/ ash veneer	392.848.80
--------------------------------	------------



**KUNGSFORS suspension rail with shelf/rack/dish  
drainer\***, W64×D32×H80 cm.

Ash veneer/stainless steel/ powder coated steel	092.543.23
--	------------



**KUNGSFORS suspension rail with shelf/magnet  
knife rack\***, W64×D32×H80 cm.

Ash veneer/ stainless steel	392.543.26
--------------------------------	------------



**KUNGSFORS suspension rail with shelf/wall grid\***,  
W64×D32×H80 cm.

Stainless steel	192.543.32
-----------------	------------



**TORNVIKEN wall shelf, 50 cm.**

Grey	803.592.12
Off-white	803.935.17



**TORNVIKEN wall shelf, 120 cm.**

Grey	803.916.60
Off-white	603.916.61



**BOTKYRKA wall shelf, 80x20 cm, white.**

402.797.31



**TORNVIKEN wall shelf, 60x100 cm.**

Grey	803.981.00
Off-white	203.980.99



**TORNVIKEN plate shelf, 80x100 cm.**

Grey	003.944.22
Off-white	603.916.56

## Kitchen islands and sideboards

Boost your storage space and kitchen functionality while adding a social focal point in your kitchen at the same time. A kitchen island or sideboard is great for many things.



**TORNVIKEN kitchen island, 72x52x90 cm.**

Grey/oak	203.916.58
Off-white/oak	003.933.71



**TORNVIKEN kitchen island, 126x77x90 cm.**

Grey/oak	803.933.72
Off-white/oak	403.916.57



**RIMFORSA work bench, 120x63.5x92 cm.**

Stainless steel/ bamboo	903.992.84
----------------------------	------------



**VADHOLMA kitchen island, 79x63x90 cm.**

Black/oak	403.661.15
-----------	------------



**VADHOLMA kitchen island, 126x79x90 cm.**

Black/oak	203.591.54
-----------	------------



**VADHOLMA kitchen island with rack, 126x79x225 cm.**

Black/oak	592.762.28
-----------	------------

## Rails and accessories

Our selection of kitchen helpers gives you more work and storage space without the expense of a remodel.



**KUNGSFORS rail\***, stainless steel. Can also be used as a towel rail or a pot lid rack.

W40 cm	004.424.99
W56 cm	403.349.16



**KUNGSFORS s-hook\***, H6 cm, stainless steel, 5-p. Use the hooks to store your kitchenware on the wall and fit more into your cabinets and drawers.

203.349.22
------------



**KUNGSFORS tablet stand\***, W26×D13×H12 cm, stainless steel. Can be hung on KUNGSFORS rail to free up space on the worktop.

203.349.17
------------



**KUNGSFORS hook\***, H8 cm, stainless steel, 3-p. The clean shape means that you can hang several kitchen utensils on the same hook, so you can store them more efficiently and get more worktop space.

703.796.92
------------



**KUNGSFORS magnet knife rack\***, W56 cm, stainless steel. You can choose to mount it directly to the wall or with the help of KUNGSFORS suspension rail.

403.349.21
------------



**KUNGSFORS magnetic clip\***, H8 cm, stainless steel, 3-p. These magnetic clips give you more worktop space since you can hang things like recipes, shopping lists and pictures.

003.349.23
------------



**KUNGSFORS net bag**, natural, set of 2. Ideal for food storage. Keeps fruits and vegetables fresh for longer since air circulates through the net bag.

203.728.34
------------



**VIVALLA tablet stand**, 26×17 cm, bamboo veneer. You can choose to put the stand on your worktop, or to hang it on the wall for more space when cooking. The stand is stable enough for both books and tablets.

104.014.84
------------



**HULTARP magnet knife rack**, 38 cm.  
Black 804.444.42



**HULTARP rail**, 60 cm.

Black	004.487.69
Nickelplated	404.628.24
Polished/ brass-colour	504.487.76



**HULTARP rail**, 80 cm.

Black	204.487.73
Nickel-plated	904.444.32
Polished/ brass-colour	304.487.77



**HULTARP dish drainer.**

Black	604.487.66
Nickel-plated	204.444.35



**HULTARP container**, 14×16 cm.

Black	304.444.54
Green/ nickel-plated	904.444.51
White/polished brass-colour	104.628.30



**HULTARP container**, black/mesh.

14×16 cm	704.628.27
31×16 cm	204.488.34



**HULTARP hook**, 11 cm, 2-p.

Black	804.488.31
Nickel-plated	604.444.57
Polished/ brass-colour	904.488.40



**HULTARP hook**, 7 cm, 5-p.

Black	104.444.45
Nickel-plated	504.488.37
Polished/ brass-colour	104.487.78



**HULTARP kitchen roll holder.**

Black	604.444.38
Nickel-plated	604.628.37
Polished/ brass-colour	004.628.40

**NEREBY rail, birch.**

40 cm	004.673.00
60 cm	904.763.43

**NEREBY s-hook, 5-p.**

White	204.763.51
-------	------------

**NEREBY container.**

Natural	904.290.97
---------	------------

**BEKVÄM spice rack, aspen.**

Aspen	204.871.75
-------	------------

**NEREBY bag natural.**

Natural	504.667.32
---------	------------

**NEREBY wall shelf 40x10 cm.**

Birch	904.659.24
-------	------------

## Containers

With clever containers and boxes inside drawers and cabinets as well as on the wall, you'll keep things organised and easy to find. A helpful tip is to keep things

close to where they are used as this enables a smooth workflow.



**RISATORP basket**, L25xW26xH18 cm. This basket makes it easy to access and get an overview of your fruit and vegetables, and is decorative to display.

White	902.816.18
Orange	504.957.77



**KUNGSFORS container\***, Ø12xH26.5 cm. The container has a removable tray underneath that collects water from cutlery and other items that you store and keeps them dry.

Stainless steel	003.349.18
-----------------	------------



**KUNGSFORS container\***, W24xD12xH26.5 cm. The container has a removable tray underneath that collects water from cutlery and other items that you store and keeps them dry.

Stainless steel	603.349.20
-----------------	------------



**UPPDATERA cutlery caddy**, W12xL12xH24.3 cm. An attractive cutlery stand that looks just as good inside a drawer as out in the open on a shelf or kitchen worktop.

Anthracite	404.331.05
------------	------------



**VARIERA box**, W24xD17xH10.5 cm. The box is easy to carry and take out of your kitchen drawers or shelves since it has two grip-friendly handles.

White	301.550.19
Black	804.710.44
Green	104.710.47
Grey	504.710.50



**VARIERA box**, W33.5xD24xH14.5 cm, white. Easy to clean, with soft rounded corners.

White	701.772.55
-------	------------

## Sink accessories

Our sink accessories support all activities in and around the sink, helping you when preparing food and washing up. Plus, they help you to save both water and space, too.



**NORRSJÖN chopping board**, L44×W42 cm. You can place the chopping board over the sink to get more space on the worktop and to hide dirty dishes. Fits over the bowl of NORRSJÖN sinks, 54×44 cm or 73×44 cm. Solid oak.

403.397.11



**GRUNDVATTNET colander**, L46×D16×H9 cm. You can use it as a colander to rinse vegetables and salad or drain pasta. The colander's flat bottom can be used as a dish drainer for e.g. glasses to free up space on the worktop. Polypropylene plastic.

Grey 903.142.80



**NORRSJÖN colander**, L42×W19×H9 cm. The colander is designed to rest steadily on the edges of the bowl. You can use it as a colander to rinse vegetables and salad or drain pasta. Fits on the bowl of all NORRSJÖN sinks, 37×44 cm or bigger.

003.397.13



**GRUNDVATTNET washing-up bowl**, L39×D23×H16 cm. You can use the washing-up bowl as a divider in a sink with one bowl to create two bowls. You can save water by doing your dishes in the washing-up bowl instead of washing dishes under running water. Grey. Polypropylene plastic.

803.142.85



**KNIPEN detergent dispenser**, 5 dl. Mounts in the sink or worktop so you always have washing up liquid close at hand. The washing-up detergent can be refilled from above. Stainless steel/polypropylene plastic.

703.417.22

## Protectors

The drawer mats and shelf protectors dampen sounds and protects the shelves and drawers from scratches. Also the lock for kitchen drawers and cabinet is an

easy way to make your kitchen a safer and more secure place for your children.



**PASSARP drawer mat**, grey. Dampens sounds and protects drawers and shelves against scratching.

48 cm 504.715.59  
96 cm 203.159.66

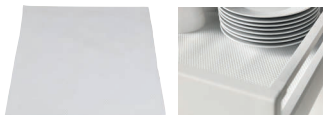

**VARIERA drawer mat**. Dampens sounds and protects drawers and shelves against scratching.

Transparent 800.128.53  
White 002.388.65



**UTRUSTA lock kitchen drawers/cabinets**, 4-p. Children are curious and can use your kitchen in ways you can never imagine. With this lock, you can easily stop them from accessing cabinets and drawers – without limiting their natural curiosity.

Black 804.536.10

## Trolleys

A trolley is a quick, easy and affordable solution giving you more flexible storage space.



**RISATORP trolley**, L57×W39×H86 cm, white. The trolley's triangular shape and baskets make what you store in them easy to both see and access.

202.816.31



**STENSTORP kitchen trolley**, W43×H90 cm. Min. depth 45 cm, max. depth 62 cm. 2 adjustable shelves in solid oak with grooves to keep bottles in place.

White/oak

402.019.16



**NISSAFORS trolley**, L50.5×W30×H83 cm. The sturdy construction and four castors make it easy for you to move the trolley and use it wherever you like. It even fits in tight spaces because of its small size

Black

203.997.77

Red-orange

804.657.45



**BEKVÄM kitchen trolley**, L58×W50×H85 cm, birch. Provides mobile extra storage, utility and work space.

302.403.48



**FLYTTA kitchen trolley**, L98×W57×H86 cm, stainless steel. Lockable castors for high stability.

000.584.87



**FÖRHÖJA kitchen trolley**, L100×W43×H90 cm, birch. Open storage with space for 9 bottles on each shelf.

800.359.20



**KUNGSFORS kitchen trolley**, L60×W40×H90 cm, stainless steel. May also be used in high humidity areas.

803.349.24

## Step stools

Sometimes all you need is a little boost. Our step stools put the top shelves within reach.



**GRUBBAN step stool**, W40×D45×H43 cm. Max load 100 kg.

Black/birch

504.729.50

White/birch

304.424.07



**BEKVÄM step stool**, W43×D39×H50 cm. Max load 100 kg.

Aspen

102.255.89

Black

404.638.52

White

401.788.88



**BEKVÄM stepladder**, 3 steps, H63 cm. Max. load 100 kg.

Beech

901.904.11

Black

902.198.29

## Guarantees

IKEA kitchens are made to stand up to the rough and tumble of everyday life in your home. Day in, day out, year after year. In fact, we're so confident of the quality of your products that we offer generous guarantees on our kitchens, worktops, appliances and taps – all for free.

### METHOD kitchen system

25-year guarantee

#### What products are covered under this guarantee?

This guarantee applies to domestic kitchen use only. This guarantee covers all of the following parts of the METHOD kitchen system: • Cabinet frames • Fronts • UTRUSTA hinges • MAXIMERA fully-extending drawers • EXCEPTIONELL fully-extending push-to-open drawers • UTRUSTA shelves of tempered glass and melamine • Plinths • Legs • Cover panels • Deco strips/mouldings

#### Products not covered under this guarantee:

Knobs and handles. ERSÄTTARE sliding-hinge for semi integrated dishwasher and BEHJÄLPLIG sliding-hinge fully integrated dishwasher.

FÖRVARA drawers, UTRUSTA wire baskets, TORNVIKEN and VADHOLMA have a 10 year guarantee.

KNOXHULT and SUNNERSTA kitchens have a 2-year guarantee.

#### What will IKEA do to correct the problem?

IKEA will examine the product and decide, at its sole discretion, if it is covered under this guarantee. If considered covered, IKEA through its own service operations, will then, at its sole discretion, replace it with the same or a comparable product. If the item is no longer sold by IKEA, IKEA will provide an appropriate replacement. It is IKEA that determines, at its sole discretion, what constitutes an appropriate replacement.

#### Conditions for the guarantees

The guarantees are valid from the date of purchase at IKEA. The original purchase receipt is required as proof of purchase.

#### Exclusions

The guarantees do not apply to products that have been stored or assembled incorrectly, used inappropriately, abused, misused, altered, or cleaned with wrong cleaning methods or wrong cleaning products. This guarantee does not cover normal wear and tear, cuts or scratches, or damage caused by impacts, accidents or waterborne debris. Follow our assembly instructions and care instructions carefully.

This guarantee does not apply if the products have been used for public use, outdoors or in a corrosive environment.

For customers in the US only: some states do not allow the limitation or exclusion of incidental or consequential damage, so this limitation or exclusion may not apply to you.

#### Care instructions

To be able to rely on this guarantee you need to follow the specific care instructions for every product. You will find all care instructions in the IKEA stores and on the IKEA web site: [www.IKEA.co.uk](http://www.IKEA.co.uk)

25

The METHOD kitchen system and worktops have a 25-year guarantee.

10

The ENHET kitchen and kitchen mixer taps have a 10-year guarantee.

#### General legal rights:

This guarantee gives you specific legal rights. This guarantee does not, in any way, affect the rights given to you by law.

#### How to reach us if you need service:

Contact your local IKEA store. You will find the address and phone number in the IKEA catalogue or at [www.IKEA.co.uk](http://www.IKEA.co.uk) Save your sales receipt as proof of purchase.

Proof of purchase is required for the guarantees to be valid.

For more information, see the IKEA Kitchen Guarantee brochure.

### ENHET kitchen system

10-year guarantee

#### What is covered under this Guarantee?

The 10-year Guarantee is valid for all ENHET products. This Guarantee applies to domestic use only.

#### What will IKEA do to correct the problem?

IKEA will examine the product and decide, at its sole discretion, if it is covered under this guarantee. If considered covered, IKEA through its own service operations, will then, at its sole discretion, replace it with the same or a comparable product. If the item is no longer sold by IKEA, IKEA will provide an appropriate replacement. It is IKEA that determines, at its sole discretion, what constitutes an appropriate replacement.

#### Conditions for the guarantees

The guarantees are valid from the date of purchase at IKEA. The original purchase receipt is required as proof of purchase.

#### Exclusions

The guarantees do not apply to products that have been stored or assembled incorrectly, used inappropriately, abused, misused, altered, or cleaned with wrong cleaning methods or wrong cleaning products. This guarantee does not cover normal wear and tear, cuts or scratches, or damage caused by impacts, accidents or waterborne debris. Follow our assembly instructions and care instructions carefully.

This guarantee does not apply if the products have been used for public use, outdoors or in a corrosive environment.

For customers in the US only: some states do not allow the limitation or exclusion of incidental or consequential damage, so this limitation or exclusion may not apply to you.

#### Care instructions

To be able to rely on this guarantee you need to follow the specific care instructions for every product. You will find all care instructions in the IKEA stores and on the IKEA web site: [www.IKEA.co.uk](http://www.IKEA.co.uk)

**General legal rights:**

This guarantee gives you specific legal rights. This guarantee does not, in any way, affect the rights given to you by law.

**How to reach us if you need service:**

Contact your local IKEA store. You will find the address and phone number in the IKEA catalogue or at [www.IKEA.co.uk](http://www.IKEA.co.uk). Save your sales receipt as proof of purchase. Proof of purchase is required for the guarantees to be valid.

For more information, see the IKEA Kitchen Guarantee brochure.

## Kitchen mixer taps

25-year guarantee

**What is covered under this Guarantee?**

The 10-year Guarantee is valid for all kitchen mixer taps at IKEA. This Guarantee applies to domestic use only and covers defects in material and workmanship in all kitchen mixer taps.

**What is not covered under this Guarantee?**

This Guarantee does not cover normal wear and tear, cuts or scratches, or damage caused by impacts, accidents or waterborne debris.

**What will IKEA do to correct the problem?**

IKEA will examine the product and decide, at its sole discretion, if it is covered under this Guarantee. If considered covered, IKEA through its own service operations, will then, at its sole discretion, replace it with the same or a comparable product. If the item is no longer sold by IKEA, IKEA will provide an appropriate replacement. It is IKEA that determines, at its sole discretion, what constitutes an appropriate replacement.

**Conditions for the Guarantees**

The Guarantees are valid from the date of purchase at IKEA. The original purchase receipt is required as proof of purchase.

**Exclusions**

The Guarantees do not apply to products that have been stored or assembled incorrectly, used inappropriately, abused, misused, altered, or cleaned with wrong cleaning methods or wrong cleaning products. This Guarantee does not cover normal wear and tear, cuts or scratches, or damage caused by impacts, accidents or waterborne debris. It also does not apply to the filter/aerator which should be cleaned regularly or replaced when worn out. Follow our assembly instructions and care instructions carefully.

This Guarantee does not apply if the products have been used for public use, outdoors or in a corrosive environment. It also does not cover accidental damage.

For customers in the US only: some states do not allow the limitation or exclusion of incidental or consequential damage, so this limitation or exclusion may not apply to you.

**Care instructions**

To be able to rely on this Guarantee you need to follow the specific care instructions for every product. You will find all care instructions in the IKEA stores and on the IKEA web site: [www.IKEA.co.uk](http://www.IKEA.co.uk)

**General legal rights:**

This Guarantee gives you specific legal rights. This Guarantee does not, in any way, affect the rights given to you by law.

**How to reach us if you need service:**

Contact your local IKEA store. You will find the address and phone number in the IKEA catalogue or at [www.IKEA.co.uk](http://www.IKEA.co.uk). Save your sales receipt as proof of purchase. Proof of purchase is required for the Guarantees to be valid.

## Worktops

25-year guarantee

**What products are covered under this Guarantee?**

This Guarantee applies to domestic kitchen use only. All worktops. • Sinks except FYNDIG

**Products not covered under this guarantee**

FYNDIG sink.

From alterations performed after initial installation. The Guarantee is effective only if the owner of the worktop is the occupant of an indoor single-family residence.

# Steps to buying an IKEA kitchen

IKEA kitchens are designed so that you can install them yourself. To the right are some steps to ensure the process goes well for you. Should you have any questions, don't hesitate to talk to our kitchen experts at your local IKEA store or visit us at: [IKEA.co.uk](http://IKEA.co.uk).



## Find your style

It's time to dream a little, look at some ideas, consider your needs and decide what an ideal kitchen means for you. This buying guide is made to give you an overview of some of the possibilities but there is so much more. You can find more ideas and inspiration on our website, in the kitchen brochure or by visiting your local IKEA store.



## Measure

When measuring it's important to take your time and get your measurements correct. This will form the foundation of all your planning. To see exactly what to measure, pick up a copy of the planning guide Your new IKEA kitchen at your local IKEA store or at [IKEA.co.uk](http://IKEA.co.uk).

## More tools and guidance



### Appliances buying guide

This buying guide is filled with appliances developed to match perfectly with our kitchens. Inside you'll find detailed information about styles, functions and prices. Pick up a copy at your local IKEA store, or flip it through online at [IKEA.co.uk](http://IKEA.co.uk)



### IKEA Kitchen planner

Design the METOD kitchen of your dreams in a 3D environment and get a price on every detail as well as the total kitchen. Print out your drawings and product list at home, or save to the IKEA website. At the IKEA store you can discuss your design and get lots of advice and guidance from our kitchen experts. Learn more at [IKEA.co.uk](http://IKEA.co.uk)



### ENHET kitchen planner

You can rely on the ENHET kitchen planner to make your purchase as fast and smooth as possible. Online you will find a display of the ready made complete kitchen solutions that our design experts have put together, based on years of experience from kitchen design. After having selected your favourite solution with a click, you can customise features, such as fronts, worktop, sink, tap, knobs/handles and appliances.



### Plan

Planning your kitchen is when your dreams and ideas take shape. Use the online IKEA Kitchen Planner to start planning your kitchen. Or, if you would like some advice we have kitchen planners ready in the store and online to help.

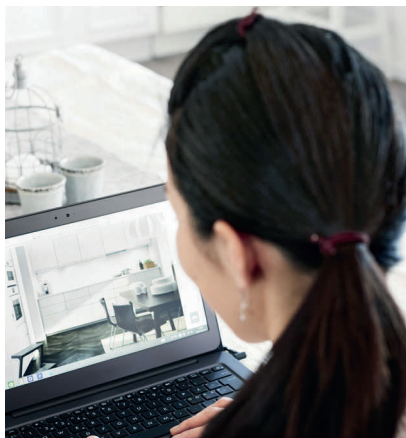

### Order

When you're satisfied with your planning, visit your local IKEA store and talk to our kitchen experts. They will go over your kitchen plan with you, and help you with anything you're not sure about. When you are ready you can order and we can help with delivery.



### Install

IKEA kitchens are designed to be installed by you, but we're here to offer as much help as you feel you need. You can start by picking up the kitchen installation guide from the store which gives step-by-step instructions on installing your kitchen.

