

# SMAKSAK

DK

NL

GB

FR

DE

IT

NO

PT

ES



Design and Quality  
IKEA of Sweden

<b>DANSK</b>	<b>6</b>
<b>NEDERLANDS</b>	<b>10</b>
<b>ENGLISH</b>	<b>14</b>
<b>FRANÇAIS</b>	<b>17</b>
<b>DEUTSCH</b>	<b>21</b>
<b>ITALIANO</b>	<b>25</b>
<b>NORSK</b>	<b>29</b>
<b>PORTUGUÊS</b>	<b>33</b>
<b>ESPAÑOL</b>	<b>37</b>

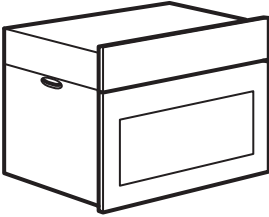
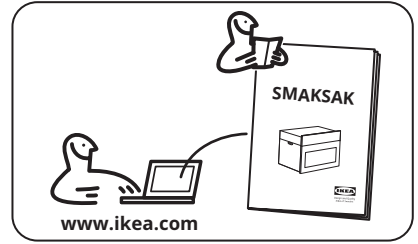
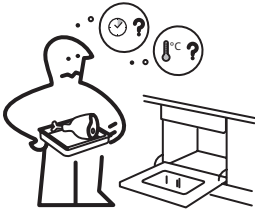

1x

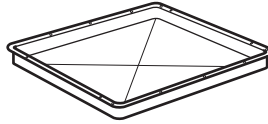

1x



1x



1x

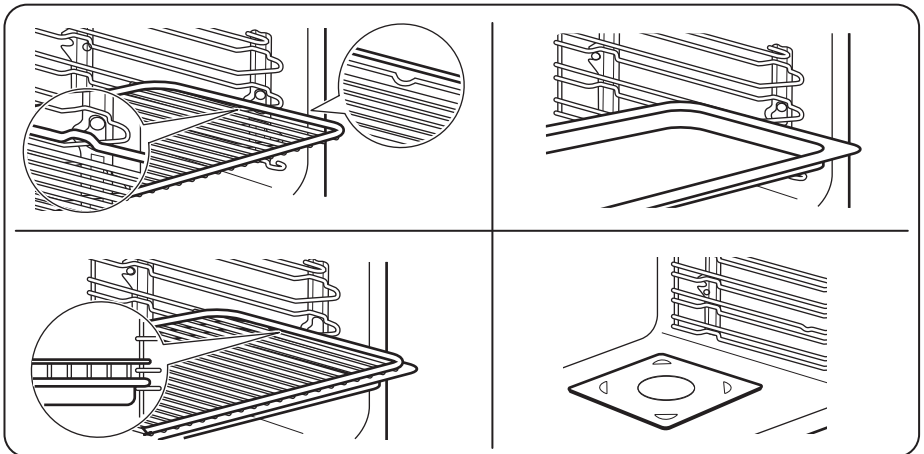

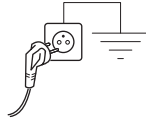

- 1
- 2

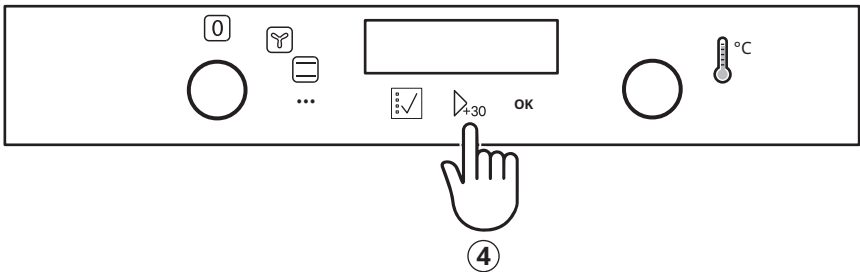
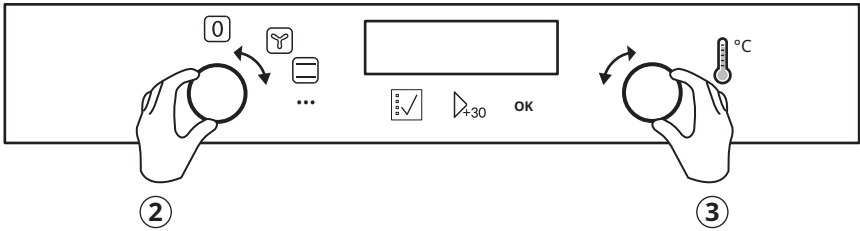
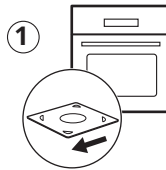

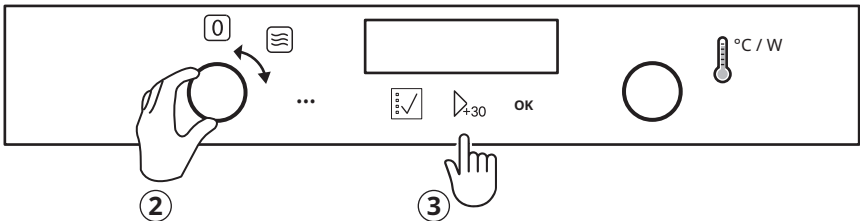
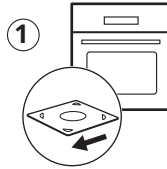
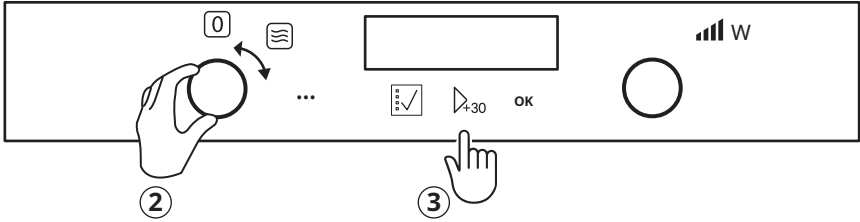
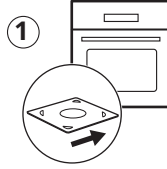

## Generelt overblik

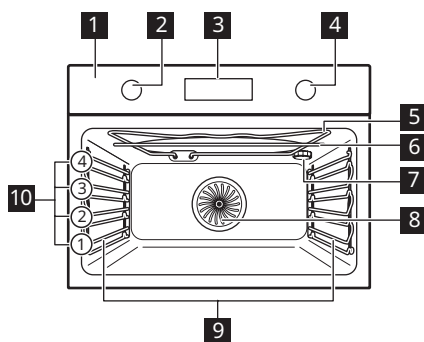

- 1** Betjeningspanel
- 2** Knap til ovnfunktioner
- 3** Display
- 4** Kontrolknap
- 5** Varmelegeme
- 6** Mikrobølgegenerator
- 7** Ovnprære
- 8** Blæser
- 9** Ovnribbe, udtagelig
- 10** Ovnriller

## Knapper

		OK
Indstilling af urfunktionstasterne. Kontrol af ovntemperaturen. Fungerer kun, mens en ovnfunktion er i gang.	For at starte en ovnfunktion. Tryk for at forlænge Mikrobølgefunktionens varighed med 30 sekunder.	For at bekræfte.



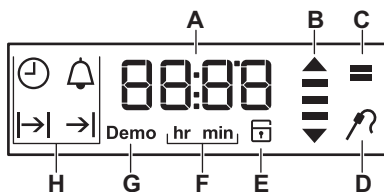





## Display



- A. Timer / Temperatur / Mikrobølgeeffekt
- B. Opvarmnings-/restvarmeindikator
- C. Mikrobølgefunktion
- D. Termometer (kun udvalgte modeller)
- E. Elektronisk lågelås (kun udvalgte modeller)
- F. Timer/minutter
- G. Demo funktion (kun udvalgte modeller)
- H. Urfunktioner

## Ovnfunktioner

- Sluk-position** Ovn er slukket
- Tilberedning med varmluft** Jævn bagning, mørt kød, tørring

-  **Konventionel (over-/undervarme)** Traditionel bagning
-  **Grillstegning** Grillstegning, ristning
-  **Varmluft + mikrobølge** Baging
-  **Over-/undervarme + Mikrobølger** Baging, stegning
-  **Grill + Mikrobølge** Tilberedning/bruning.
-  **Mikrobølger** Opvarmning, tilberedning, effektområde: 100 - 1000 W
-  **Væsker** Opvarmning af drikkevarer og supper, effektområde: 800 - 1000 W
-  **Optøning** Optøning af kød, fisk, kager, effektområde: 100 - 200 W
-  **Genopvarmning** Opvarmning af færdigretter og delikat mad, effektområde: 300 - 700 W

## Mikrobølgeegnet kogegrej og materialer

Kun kogegrej og materialer, der er velegnet til mikrobølge. Brug nedenstående tabel som reference.

Kontrollér kogegrejet/ materialespecifikationen inden brug.

Kogegrej/materiale	Mikrobølge-funktion		Mikrobølge/kombi-funktion f.eks. 
	Optøning	Varme, Tilberedning	
Ovnfast glas og porcelæn uden metal-komponenter, f.eks. ildfast glas	✓	✓	✓
Ikke-ovnfast glas og porcelæn uden sølv-, guld-, platin- eller andre metal-dekorationer	✓	X	X
Glas og glaskeramik lavet af ovnfast/frostsikkert materiale	✓	✓	✓
Keramik og lertøj uden kvarts eller metalkomponenter og glaseringer, som indeholder metal	✓	✓	X
Keramik, porcelæn og lertøj med uglaseret bund eller med små huller, f.eks. på håndtag	X	X	X
Varmebestandig plast op til 200 °C	✓	✓	X

Kogegrej/materiale	Mikrobølge-funktion		Mikrobølge/kombi-funktion f.eks. 
	Optøning	Varme, Tilberedning	
Karton, papir	✓	X	X
Film	✓	X	X
Stegefilm med lukning, der er beregnet til mikrobølge	✓	✓	X
Stegning af metal, f.eks. emalje, støbejern	X	X	✓
Bageforme, sort lak eller silikonebelagt	X	X	✓
Bageplade	X	X	X
Grillrist	X	X	✓
Bundplade af glas i mikroovn	✓	✓	X
Kogegrej til mikrobølge, f.eks. fad	X	✓	X

## Fejlfinding

Hvis du støder på et problem med dit apparat, kan du se kapitlet "Fejlfinding" i den

fulde version af brugervejledningen, som findes på: [www.ikea.com](http://www.ikea.com).

## Tekniske data

Mål (indvendigt)	Bredde Højde Dybde	480 mm 217 mm 411 mm
Brugbare mængder	43 l	
Område til bageplade	1424 cm <sup>2</sup>	
Øverste varmelegeme	1900 W	
Nederste varmelegeme	1000 W	
Grill	1900 W	
Kreds	1650 W	
Effekt i alt	3000 W	



Spænding	220 - 240 V
Frekvens	50 Hz
Antal funktioner	10

## Algemeen overzicht

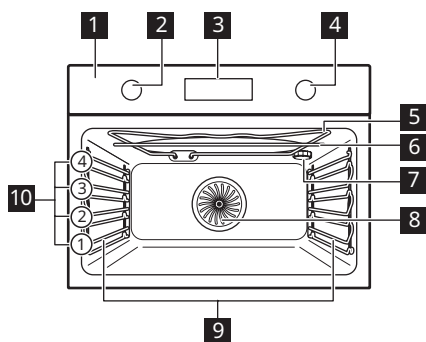

- 1 Bedieningspaneel
- 2 Knop voor verwarmingsfuncties
- 3 Display
- 4 Bedieningsknop
- 5 Verwarmingselement
- 6 Magnetrongenerator
- 7 Lamp
- 8 Ventilator
- 9 Inschuifrails, verwijderbaar
- 10 Inzetniveaus

## Knoppen

		OK
De klokfuncties instellen. Om de oventemperatuur te controleren. Uitsluitend gebruiken als een verwarmingsfunctie in werking is.	Om een verwarmingsfunctie te starten. Eveneens om de magnetronfunctieduur met 30 seconden te verlengen.	Ter bevestiging.



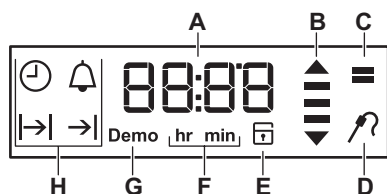







## Display



- A. Timer / Temperatuur / Magnetronvermogen
- B. Opwarmings- en restwarmte-indicator
- C. Magnetronmodus
- D. Voedselsensor (alleen geselecteerde modellen)
- E. Deurslot (alleen geselecteerde modellen)
- F. Uren/minuten
- G. Demofunctie (alleen geselecteerde modellen)
- H. Klokfuncties

## Verwarmingsfuncties

- Uit-stand** De oven staat uit

-  **Hete lucht koken** Zelfs bakken, malsheid, drogen
-  **Conventioneel (boven- en onderwarmte)** Traditioneel bakken
-  **Grillen** Grillen, roosteren
-  **Hetelucht + magnetron** Bakken
-  **Boven- en onderwarmte + magnetron** Bakken, braden
-  **Grill + magnetron** Koken/bruinen.
-  **Magnetron** Opwarmen, koken, vermogensbereik: 100 - 1000 W
-  **Vloeistoffen** Opwarmen van dranken en soepen, vermogensbereik: 800 - 1000 W
-  **Ontdooien** Vlees, vis, gebak ontdooien, vermogensbereik: 100 - 200 W
-  **Opwarmen** Vermogensbereik voor het opwarmen van vooraf bereide maaltijden en delicate gerechten: 300 - 700 W

## Kookgerei en materialen geschikt voor de magnetron

Gebruik alleen kookgerei en materiaal in de magnetron dat hier geschikt voor is. Gebruik onderstaande tabel als referentie.

Controleer de specificaties van het kookgerei/materiaal voor gebruik.

Kookgerei/materiaal	Magnetronfunctie		Combimagnetronfunctie bijv. 
	Ontdooien	Opwarmen, Koken	
Ovenvast glas en porselein zonder metalen onderdelen, bijv. hittebestendig glas	✓	✓	✓
Niet-ovenbestendig glas en porselein zonder zilveren, gouden, platina of andere metalen versieringen	✓	X	X
Glas en glaskeramik van ovenbestendig / diepvriesbestendig materiaal	✓	✓	✓
Keramik en aardewerk zonder kwarts of metalen onderdelen en metaalhoudend glazuur	✓	✓	X
Keramik, porselein en aardewerk met ongeglazuurde onderkant of met kleine gaatjes, bijv. op handvaten	X	X	X

Kookgerei/materiaal	Magnetronfunctie		Combimagnetron- functie bijv. 
	Ontdooien	Opwarmen, Koken	
Tot 200 °C hittebestendige kunststof	✓	✓	X
Karton, papier	✓	X	X
Huishoudfolie	✓	X	X
Ovenfolie met magnetronveilige sluiting	✓	✓	X
Braadschalen gemaakt van metaal, bijv. email, gietijzer	X	X	✓
Bakblikken, zwarte lak of met siliconen coating	X	X	✓
Bakplaat	X	X	X
Bakrooster	X	X	✓
Glazen bodemplaat magnetron	✓	✓	X
Kookgerei voor gebruik in magnetron, bijv. pan voor knapperige gerechten	X	✓	X

## Probleemoplossing

Als u op een probleem met uw apparaat stuit, raadpleeg dan het hoofdstuk "Probleemoplossing" in de volledige versie

van de gebruikershandleiding, beschikbaar op: [www.ikea.com](http://www.ikea.com).

## Technische gegevens

Afmetingen (intern)	Breedte Hoogte Diepte	480 mm 217 mm 411 mm
Bruikbare volumes	43 l	
Plaats bakplaat	1424 cm <sup>2</sup>	
Bovenste verwarmingselement	1900 W	
Onderste verwarmingselement	1000 W	
Grillen	1900 W	

Ring	1650 W
Totale beoordeling	3000 W
Spanning	220 - 240 V
Frequentie	50 Hz
Aantal functies	10

**General overview**

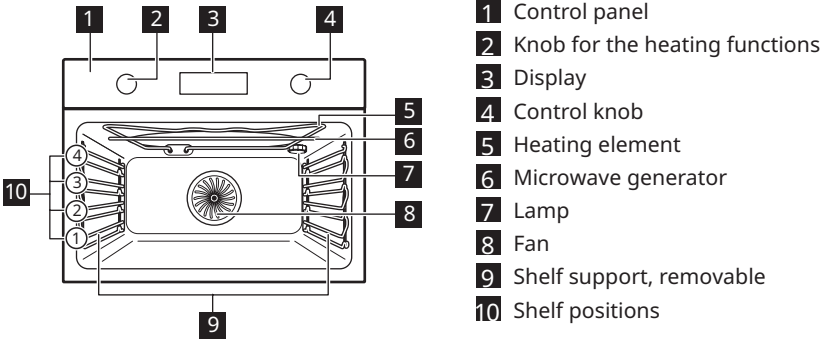

**Buttons**

		OK
To set the clock functions. To check the oven temperature. Use only while a heating function operates.	To start a heating function. Also to extend Microwave function duration for 30 seconds.	To confirm.



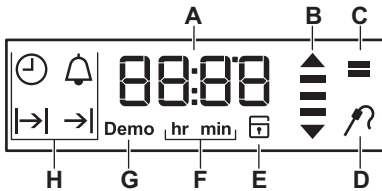





**Display**



- A. Timer / Temperature / Microwave power
- B. Heat-up and residual heat indicator
- C. Microwave mode
- D. Food Sensor (selected models only)
- E. Door lock (selected models only)
- F. Hours / minutes
- G. Demo mode (selected models only)
- H. Clock functions

**Heating Functions**

- Off position**      The oven is off
- Forced Air Cooking**      Even baking, tenderness, drying
- Conventional (Top and Bottom Heat)**      Traditional baking

-  **Grilling**      Grilling, toasting
-  **True Fan**      Baking
-  **Cooking + MW**
-  **Conventional Cooking + MW**      Baking, roasting
-  **Grill + MW**      Cooking, browning.
-  **Microwave**      Heating up, cooking, power range: 100 - 1000 W
-  **Liquids**      Heating up drinks and soups, power range: 800 - 1000 W
-  **Defrost**      Defrosting meat, fish, cakes, power range: 100 - 200 W
-  **Reheating**      Heating up pre-prepared meals and delicate food, power range: 300 - 700 W

## Microwave suitable cookware and materials

For the microwave use only suitable cookware and materials. Use below table as a reference.

Check the cookware / material specification before use.

Cookware / Material	Microwave function		Microwave Combi function e.g. 
	Defrosting	Heating, Cooking	
Ovenproof glass and porcelain with no metal components, e.g. heat-proof glass	✓	✓	✓
Non-ovenproof glass and porcelain without any silver, gold, platinum or other metal decorations	✓	X	X
Glass and glass ceramic made of ovenproof / frost-proof material	✓	✓	✓
Ceramic and earthenware without any quartz or metal components and glazes which contain metal	✓	✓	X
Ceramic, porcelain and earthenware with unglazed bottom or with small holes, e.g. on handles	X	X	X
Heat-resistant plastic up to 200 °C	✓	✓	X
Cardboard, paper	✓	X	X
Clingfilm	✓	X	X

Cookware / Material	Microwave function		Microwave Combi function e.g. 
	Defrosting	Heating, Cooking	
Roasting film with microwave safe closure	✓	✓	X
Roasting dishes made of metal, e.g. enamel, cast iron	X	X	✓
Baking tins, black lacquer or silicon-coated	X	X	✓
Baking tray	X	X	X
Wire shelf	X	X	✓
Microwave glass bottom plate	✓	✓	X
Cookware for microwave use, e.g. crisp pan	X	✓	X

## Troubleshooting

If you encounter an issue with your appliance, check "Troubleshooting" chapter

in the full version of the User Manual available on: [www.ikea.com](http://www.ikea.com).

## Technical data

Dimensions (internal)	Width Height Depth	480 mm 217 mm 411 mm
Usable volumes	43 l	
Area of baking tray	1424 cm <sup>2</sup>	
Top heating element	1900 W	
Bottom heating element	1000 W	
Grill	1900 W	
Ring	1650 W	
Total rating	3000 W	
Voltage	220 - 240 V	
Frequency	50 Hz	
Number of functions	10	



## Vue d'ensemble

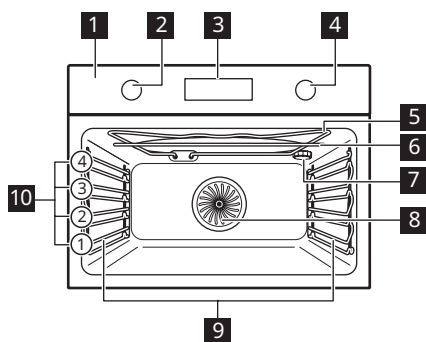

- 1 Bandeau de commande
- 2 Manette de sélection des modes de cuisson
- 3 Affichage
- 4 Manette de commande
- 5 Résistance
- 6 Générateur de micro-ondes
- 7 Éclairage
- 8 Chaleur tournante
- 9 Support de grille, amovible
- 10 Niveaux de la grille

## Touches





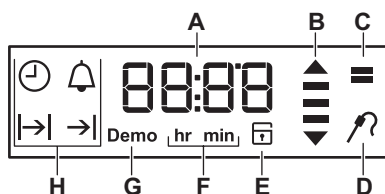





		OK
Pour régler les fonctions de l'horloge. Pour vérifier la température du four. À utiliser seulement lorsqu'un mode de cuisson est activé.	Pour activer un mode de cuisson. Aussi pour rallonger la durée de la fonction Micro-ondes de 30 secondes.	Pour confirmer.

## Affichage



- A. Minuteur / Température / Puissance des micro-ondes
- B. Voyant de chauffe et de chaleur résiduelle
- C. Mode micro-ondes
- D. Sonde de cuisson (uniquement sur certains modèles)
- E. Verrouillage de la porte (sur certains modèles uniquement)
- F. Heures/minutes
- G. Mode démo (uniquement sur certains modèles)
- H. Fonctions de l'horloge

## Modes de cuisson

-  **Position d'arrêt** Le four est éteint
-  **Cuisson à air pulsé** Cuisson homogène, tendreté, séchage
-  **Conventionnel (chauffage haut/bas)** Cuisson traditionnelle
-  **Gril** Griller, toaster
-  **Chaleur tournante + Micro-ondes** Cuisson
-  **Chauffage Haut/Bas + Micro-ondes** Cuisson, rôtissage
-  **Gril + Micro-ondes** Cuire, faire dorer.
-  **Micro-ondes** Chauffage, cuisson, plage de puissance : 100 à 1 000 W
-  **Liquides** Chauffage de boissons et de soupes, plage de puissance : 800 à 1 000 W
-  **Décongélation** Décongélation de viande, poisson, gâteaux, plage de puissance : 100 à 200 W
-  **Réchauffer** Chauffage de plats préparés et d'aliments délicats, plage de puissance : 300 à 700 W

## Ustensiles de cuisine et matériaux adaptés aux micro-ondes

Pour la cuisson au micro-ondes, n'utilisez que des récipients et matériaux adaptés. Utilisez le tableau ci-dessous comme référence.

Vérifiez les caractéristiques des ustensiles de cuisine / des matériaux avant utilisation.

Ustensiles de cuisine / Matériaux	Fonction micro-ondes		Fonction combi Micro-ondes par ex. 
	Décongélation	Réchauffage, Cuisson	
Verre et porcelaine allant au four ne contenant aucun composant métallique, par ex. le verre résistant à la chaleur	✓	✓	✓
Verre et porcelaine n'allant pas au four sans décor en argent, or, platine ou métal	✓	X	X

Ustensiles de cuisine / Matériaux	Fonction micro-ondes		Fonction combi Mi-cro-ondes par ex. 
	Décongélation	Réchauffage, Cuisson	
Verre et vitrocéramique en matériau résistant aux températures élevées/basses	✓	✓	✓
Récipients en céramique et en faïence sans composant en quartz ou en métal, ni vernis contenant du métal	✓	✓	X
Céramique, porcelaine et faïence dont le fond n'est pas verni ou avec de petits trous, par exemple sur les poignées	X	X	X
Plastique résistant à la chaleur jusqu'à 200 °C	✓	✓	X
Carton, papier	✓	X	X
Film étirable	✓	X	X
Sachet de cuisson avec fermeture de sûreté pour micro-ondes	✓	✓	X
Plats à rôtir en métal, par ex. en émail, en fonte	X	X	✓
Moules à gâteaux, laqués noirs ou avec revêtement en silicone	X	X	✓
Plateau de cuisson	X	X	X
Grille métallique	X	X	✓
Plateau en verre du micro-ondes	✓	✓	X
Ustensiles pour une utilisation au micro-ondes, par ex. plat pour cuisson croustillante	X	✓	X

## Dépannage

Si vous rencontrez un problème avec votre appareil, consultez le chapitre « Dépannage » dans la version complète du

Manuel de l'utilisateur disponible sur : [www.ikea.com](http://www.ikea.com).

**Données techniques**

Dimensions (internes)	Largeur Hauteur Profondeur	480 (mm) 217 (mm) 411 (mm)
Volumes utilisables	43 l	
Zone du plateau de cuisson	1424 cm <sup>2</sup>	
Chauffage de voûte	1900 W	
Chauffage de sole	1000 W	
Gril	1900 W	
Circuit	1650 W	
Puissance totale	3000 W	
Tension	220 - 240 V	
Fréquence	50 Hz	
Nombre de fonctions	10	

**Gesamtansicht**

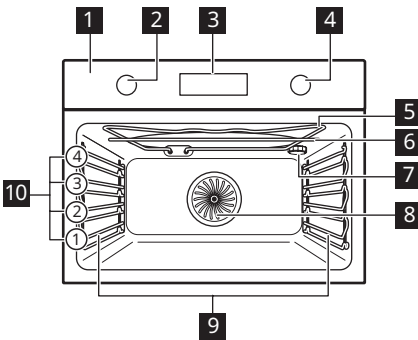

- 1 Bedienfeld
- 2 Einstellknopf für die Ofenfunktionen
- 3 Display
- 4 Einstellknopf
- 5 Heizelement
- 6 Mikrowellengenerator
- 7 Lampe
- 8 Ventilator
- 9 Einschubschienen, herausnehmbar
- 10 Einschubebenen

**Knöpfe**

		OK
Einstellen der Uhrenfunktionen. Abfrage der Backofentemperatur. Nur verwenden, wenn eine Ofenfunktion in Betrieb ist.	Zum Starten einer Ofenfunktion. Ebenso, um die Mikrowellenfunktion um 30 Sekunden zu verlängern.	Zur Bestätigung.



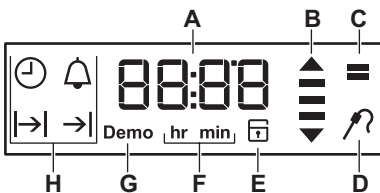





**Display**



- A. Timer/Temperatur/Mikrowellenleistung
- B. Aufheiz- und Restwärmeanzeige
- C. Mikrowellen-Modus
- D. Temperatursensor (nur ausgewählte Modelle)
- E. Türverriegelung (nur ausgewählte Modelle)
- F. Stunden/Minuten
- G. DEMO (nur ausgewählte Modelle)
- H. Uhrfunktionen

**Ofenfunktionen**

- Aus-Position** Der Backofen ist ausgeschaltet
- Umluftgaren** Gleichmäßiges Backen, Zartheit, Dörren

-  **Konventionell** Traditionelles Backen  
**(Ober-/Unterhitze)**
-  **Grillen** Grillen, Braten
-  **Heißluft + MW** Backen
-  **Ober-/Unterhitze + MW** Backen, Braten
-  **Grill + MW** Kochen, Bräunen.
-  **Mikrowelle** Aufwärmen, Kochen, Leistungsbereich: 100 - 1000 W
-  **Flüssigkeiten** Aufwärmen von Getränken und Suppen, Leistungsbereich: 800 - 1000 W
-  **Auftauen** Auftauen von Fleisch, Fisch, Kuchen, Leistungsbereich: 100 - 200 W
-  **Aufwärmen** Aufheizen von vorbereiteten Mahlzeiten und empfindlichen Lebensmitteln, Leistungsbereich: 300 - 700 W

## Mikrowellengeeignetes Kochgeschirr und Materialien

Verwenden Sie nur mikrowellengeeignetes Kochgeschirr und Materialien. Verwenden Sie die folgende Tabelle als Referenz.

Prüfen Sie vor der Verwendung die Kochgeschirr- und Materialspezifikationen.

Kochgeschirr / Material	Mikrowellenfunktion		Mikrowellen-Kombifunktion z. B. 
	Auftauen	Erwärmen, Kochen	
Feuerfestes Glas und Porzellan ohne Metallteile, z. B. hitzebeständiges Glas	✓	✓	✓
Nicht feuerfestes Glas und Porzellan ohne Verzierung aus Silber, Gold, Platin oder Metall	✓	X	X
Glas und Glaskeramik aus hitze-/frostbeständigem Material	✓	✓	✓
Keramik und Steingut ohne Quarz- oder Metallteile oder metallhaltige Glasur	✓	✓	X
Keramik, Porzellan und Steingut mit unglasiertem Boden oder mit kleinen Löchern, z. B. auf den Griffen	X	X	X
Hitzebeständiger Kunststoff bis 200 °C	✓	✓	X
Pappe, Papier	✓	X	X

Kochgeschirr / Material	Mikrowellenfunktion		Mikrowellen-Kombifunktion z. B. 
	Auftauen	Erwärmen, Kochen	
Frischhaltefolie	✓	X	X
Bratfolie mit mikrowelleneigenem Verschluss	✓	✓	X
Bratgeschirr aus Metall, z. B. Emaille, Gusseisen	X	X	✓
Backformen, schwarz lackiert oder silikonbeschichtet	X	X	✓
Backblech	X	X	X
Gitterrost	X	X	✓
Mikrowellen-Bodenplatte aus Glas	✓	✓	X
Kochgeschirr für die Mikrowelle, z. B. Knusperpfanne	X	✓	X

## Problembekämpfung

Wenn Sie ein Problem mit Ihrem Gerät haben, lesen Sie das Kapitel „Fehlerbehebung“ in der Vollversion des

Benutzerhandbuchs, das auf folgenden Seiten verfügbar ist: [www.ikea.com](http://www.ikea.com).

## Technische Daten

Abmessungen (intern)	Breite Höhe Tiefe	480 mm 217 mm 411 mm
Nutzbare Volumen	43 l	
Backblechgröße	1424 cm <sup>2</sup>	
Oberes Heizelement	1900 W	
Unteres Heizelement	1000 W	
Grill	1900 W	
Ring	1650 W	
Gesamtbewertung	3000 W	
Spannung	220 - 240 V	

Frequenz	50 Hz
Anzahl der Funktionen	10



## Panoramica generale

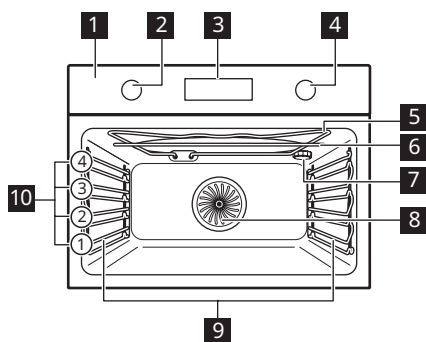

- 1 Pannello dei comandi
- 2 Manopola di regolazione delle funzioni cottura
- 3 Display
- 4 Manopola di regolazione
- 5 Resistenza
- 6 Generatore microonde
- 7 Lampadina
- 8 Ventola
- 9 Supporto ripiano, rimovibile
- 10 Posizioni ripiano

## Tasti

		OK
Per impostare le funzioni dell'orologio. Per controllare la temperatura del forno. Utilizzare solo mentre la funzione di riscaldamento è attiva.	Per avviare una funzione di riscaldamento. Per estendere anche la durata della funzione Microonde di 30 secondi.	Per confermare.



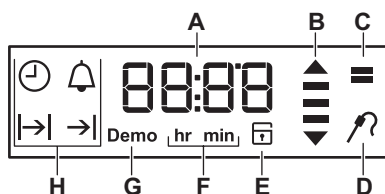







## Display



- A. Timer / Temperatura / Potenza microonde
- B. Indicatore di riscaldamento e di calore residuo
- C. Modalità microonde
- D. Termosonda (solo modelli selezionati)
- E. Chiusura porta (solo modelli selezionati)
- F. Ore/minuti
- G. Modalità demo (solo modelli selezionati)
- H. Funzioni dell'orologio

## Funzioni cottura

- 0 **Posizione spento** Il forno è spento

-  **Cottura a circolazione d'aria forzata** Cottura omogenea, tenerezza, essiccazione
-  **Cottura statica (resistenza superiore e inferiore)** Cottura tradizionale
-  **Cottura al grill** Cottura alla griglia, tostatura
-  **Cottura ventilata + Microonde** Cottura al forno
-  **Cottura convenzionale + Microonde** Cottura al forno, arrosto
-  **Grill + Microonde** Cottura, rosolatura.
-  **Microonde** Riscaldamento, cottura, gamma di potenza: 100 - 1.000 W
-  **Liquidi** Riscaldamento di bevande e zuppe, gamma di potenza: 800 - 1.000 W
-  **Scongelamento** Scongelamento di carne, pesce, torte, gamma di potenza: 100 - 200 W
-  **Riscaldamento** Riscaldamento di pasti pronti e alimenti delicati, gamma di potenza: 300 - 700 W

## Pentole e materiali adatti per un uso in microonde

Per il microonde usare solo tegami e materiali adeguati. Usare la seguente tabella come riferimento.

Controllare le specifiche delle pentole/del materiale prima dell'uso.

Pentole / Materiale	Funzione microonde		Funzione microonde combo ad esempio 
	Scongela-mento	Riscaldamen-to, Cottura	
Vetro e porcellana termoresistente (senza componenti metallici, ad es. vetro a prova di calore)	✓	✓	✓
Vetro e porcellana non resistente al fuoco senza applicazioni o decorazioni in argento, oro, platino o metallo	✓	X	X
Vetro e vetroceramica in materiale resistente al fuoco / al gelo	✓	✓	✓

Pentole / Materiale	Funzione microonde		Funzione microonde combo ad esempio 
	Scongela- mento	Riscaldamen- to, Cottura	
Articoli in ceramica e terracotta, senza componenti al quarzo o componenti metalliche e smalti che contengono metallo	✓	✓	X
Ceramica, porcellana e oggetti di terracotta con parte inferiore non in vetro o con fori piccoli, ad esempio sulle maniglie	X	X	X
Plastica termoresistente fino a 200 °C	✓	✓	X
Cartoncino, carta	✓	X	X
Pellicola	✓	X	X
Sacchetti di cottura con chiusura adatta alle microonde	✓	✓	X
Piatti per arrosto in metallo, ad es. smalto, ghisa	X	X	✓
Teglie laccate in nero o rivestite in silicone	X	X	✓
Lamiera dolci	X	X	X
Ripiano a filo	X	X	✓
Piatto inferiore in vetro del microonde	✓	✓	X
Pentole che possono essere usate in microonde, ad esempio piatto crisp	X	✓	X

## Risoluzione dei problemi

In caso di problemi con l'apparecchiatura consultare il capitolo "Risoluzione dei problemi" nella versione completa del

Manuale d'uso disponibile su:  
[www.ikea.com](http://www.ikea.com).

**Dati tecnici**

Dimensioni (interne)	Larghezza Altezza Profondità	480 mm 217 mm 411 mm
Volumi utilizzabili	43 l	
Area della lamiera dolci	1424 cm <sup>2</sup>	
Resistenza superiore	1900 W	
Resistenza inferiore	1000 W	
Grill	1900 W	
Anello	1650 W	
Valutazione totale	3000 W	
Tensione	220 - 240 V	
Frequenza	50 Hz	
Numero di funzioni	10	

## Generell oversikt

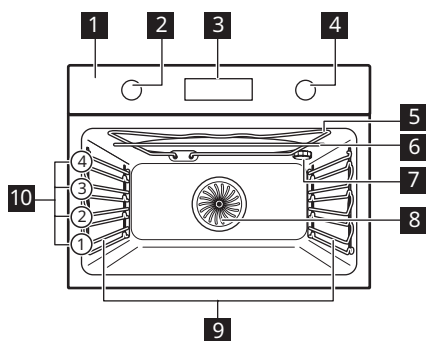

- 1** Betjeningspanel
- 2** Bryter for ovnsfunksjoner
- 3** Display
- 4** Betjeningsbryter
- 5** Varmeelement
- 6** Mikrobølgegenerator
- 7** Lys
- 8** Vifte
- 9** Uttakbare brettstiger
- 10** Hyllnivåer

## Brytere

		OK
Slik stiller du inn klokkefunksjonene. For å sjekke stekovnstemperaturen. Skal kun brukes hvis en varmekonfunksjon er i bruk.	For å starte en oppvarmingsfunksjon. Også for å utvide mikrobølgefunksjonsvarighet med 30 sekunder.	For å bekrefte.



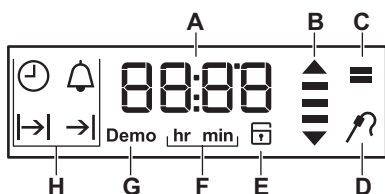





## Display



- A. Timer / Temperatur / Mikrobølgeeffekt
- B. Varme opp og restvarmeindikator
- C. Mikrobølgeovn-modus
- D. Steketermometer (bare utvalgte modeller)
- E. Elektronisk dørlås (bare for utvalgte modeller)
- F. Timer/minutter
- G. Demomodus (bare utvalgte modeller)
- H. Klokkefunksjoner

## Ovnsfunksjoner

- Av-posisjon**      Ovenn er av
- Tilberedning med varmluft**      Tilberedning, mørhet, tørking

-  **Alminnelig ovn** Tradisjonell steking  
**(Over-/Undervarme)**
-  **Grilling** Grilling, risting
-  **Ekte varmluft + mikrobølge** Baking
-  **O-/undervarme + mikro** Baking, steking
-  **Grill + Mikrobølge** Steking, bruning.
-  **Mikrobølge** Oppvarming, matlaging, effektområde: 100–1000 W
-  **Væske** Oppvarming av drikke og supper, effektområde: 800–1000 W
-  **Tining** Tining av kjøtt, fisk, kaker, effektområde: 100–200 W
-  **Gjenoppvarming** Oppvarming av forhåndslagde måltider og delikat mat, effektområde: 300–700 W

## Egnede kokekar og materialer for mikrobølgeovn

Bruk bare egnede kokekar og materialer i mikrobølgeovnen. Bruk tabellen nedenfor som referanse.

Sjekk spesifikasjonene for kokekar/materiale før bruk.

Kokekar/materiale	Mikrobølgeovnfunksjon		Mikrobølgeovnens kombifunksjon f.eks. 
	Tining	Oppvarming, Tilberedning	
Ildfast glass og porselen uten metall-deler, f.eks. varmefast glass	✓	✓	✓
Ikke-ildfast glass og porselen uten sølv-, gull-, platina- eller metallbelegg/dekor	✓	X	X
Glass og glasskeramikk av ovns-/frost-sikkert materiale	✓	✓	✓
Keramikk og steintøy uten kvarts- eller metallkomponenter og glasur som inneholder metall	✓	✓	X
Keramikk, porselen eller steintøy som har uglassert bunn eller små hull, f.eks. på håndtaket	X	X	X
Varmebestandig plast opptil 200 °C	✓	✓	X
Papp, papir	✓	X	X

Kokekar/materiale	Mikrobølgeovnfunksjon		Mikrobølgeovens kombifunksjon f.eks. 
	Tining	Oppvarming, Tilberedning	
Plastfolie	✓	X	X
Stekefolie med lukking som er egnet for mikrobølgeovner	✓	✓	X
Stekeformer av metall, f.eks. emalje, støpejern	X	X	✓
Kakeformer, svartlakkerte eller silikonbelagte	X	X	✓
Stekebrett	X	X	X
Rist	X	X	✓
Bunntallerken i glass for mikrobølgeovn	✓	✓	X
Kokekar for bruk i mikrobølgeovn, f.eks. ristpanne	X	✓	X

## Feilsøking

Hvis du støter på et problem med produktet, sjekk kapittelet "Feilsøking" i den

fullstendige versjonen av bruksanvisningen som er tilgjengelig på: [www.ikea.com](http://www.ikea.com).

## Tekniske data

Mål (innvendig)	Bredde Høyde Dybde	480 mm 217 mm 411 mm
Bruksvolum	43 l	
Stekebrett	1424 cm <sup>2</sup>	
Overelement	1900 W	
Undervarmeelementet	1000 W	
Grill	1900 W	
Ring	1650 W	
Total rangering	3000 W	
Spenning	220 - 240 V	

For å laste ned fullversjonen, kan du besøke [www.ikea.com](http://www.ikea.com)

Frekvens	50 Hz
Antall funksjoner	10



## Resumo geral

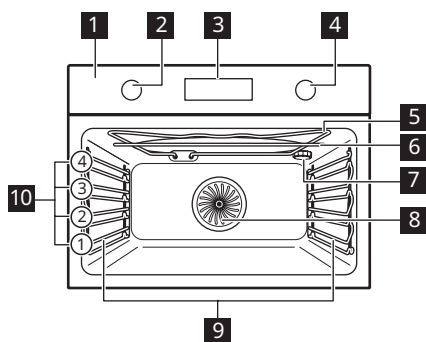

- 1** Painel de comandos
- 2** Botão para os tipos de aquecimento
- 3** Visor
- 4** Botão de controlo
- 5** Elemento de aquecimento
- 6** Gerador de micro-ondas
- 7** Lâmpada
- 8** Ventilador
- 9** Apoio para prateleira, amovível
- 10** Nível das prateleiras

## Botões





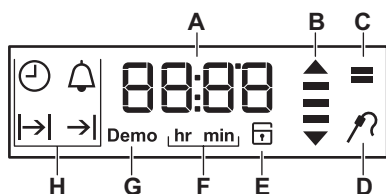





		OK
Para definir as funções de relógio. Para verificar a temperatura do forno. Utilize apenas quando um tipo de aquecimento estiver a funcionar.	Para iniciar um tipo de aquecimento. Também para prolongar a duração da função Micro-ondas durante 30 segundos.	Para confirmar.

## Visor



- A. Temporizador / Temperatura / Potência do micro-ondas
- B. Indicador de aquecimento e de calor residual
- C. Modo de micro-ondas
- D. Sonda térmica (apenas modelos selecionados)
- E. Bloqueio da porta (apenas alguns modelos)
- F. Horas/minutos
- G. Modo Demo (apenas modelos selecionados)
- H. Funções do relógio

## Funções de aquecimento

-  **Posição desligado** O forno está desligado
-  **Cozedura com ar forçado** Assado uniforme, tenro, seco
-  **Convencional (aquecimento superior e inferior)** Cozedura tradicional
-  **Grelhador** Grelhar, tostar
-  **Aquecimento ventilado + MO** Cozer no forno
-  **Cozedura convencional + MO** Cozer, assar
-  **Grelhador + MO** Cozinhar/alourar.
-  **Micro-ondas** Aquecer, cozinhar, intervalo de potência: 100 - 1000 W
-  **Líquidos** Aquecer bebidas e sopas, intervalo de potência: 800 - 1000 W
-  **Descongelar** Descongelar carne, peixe, bolos, gama de potência: 100 - 200 W
-  **Reaquecer** Aquecer refeições pré-cozinhas e alimentos delicados, intervalo de potência: 300 - 700 W

## Recipientes e materiais adequados para micro-ondas

Utilize apenas materiais e recipientes adequados para micro-ondas quando utilizar a função de micro-ondas. Utilize a tabela em baixo como referência.

Verifique as especificações do recipiente/material antes da utilização.

Recipiente/Material	Função microondas		Função combinada de micro-ondas, por exemplo, 
	Descongelar	Aquecer, Cozinhar	
Porcelana e vidro próprios para forno, sem componentes metálicos, por exemplo, vidro à prova de calor	✓	✓	✓
Vidro e porcelana não adequados para forno, sem decorações em prata, ouro, platina ou outro metal	✓	X	X
Vidro e vitrocerâmica fabricados em material adequado para forno/congelador	✓	✓	✓

Recipiente/Material	Função microondas		Função combinada de micro-ondas, por exemplo, 
	Descongelo	Aquecer, Cozinhar	
Cerâmica e barro sem componentes de quartzo ou metal, nem revestimentos que contenham metal	✓	✓	X
Cerâmica, porcelana ou barro com fundo não vidrado ou pequenos orifícios, por exemplo, nas pegas	X	X	X
Plástico resistente ao calor até 200 °C	✓	✓	X
Cartão, papel	✓	X	X
Película aderente	✓	X	X
Película própria para assados com fecho seguro para micro-ondas	✓	✓	X
Assadeiras em metal, por exemplo, esmalte, ferro fundido	X	X	✓
Formas para assar, com revestimento de silicone ou laca preta	X	X	✓
Tabuleiro para assar	X	X	X
Prateleira em grelha	X	X	✓
Prato de vidro do micro-ondas	✓	✓	X
Recipientes para utilizar em micro-ondas, por exemplo, uma frigideira de pega amovível	X	✓	X

## Resolução de problemas

Se tiver um problema com o seu aparelho, consulte o capítulo "Resolução de

problemas" na versão completa do Manual do Utilizador disponível em: [www.ikea.com](http://www.ikea.com).

## Informação técnica

Dimensões (interior)	Largura	480 mm
	Altura	217 mm
	Profundidade	411 mm
Volumes utilizáveis	43 l	

Área do tabuleiro para assar	1424 cm <sup>2</sup>
Elemento de aquecimento superior	1900 W
Elemento de aquecimento inferior	1000 W
Grelhador	1900 W
Anel	1650 W
Potência total	3000 W
Tensão	220 - 240 V
Frequência	50 Hz
Número de funções	10

**Resumen general**

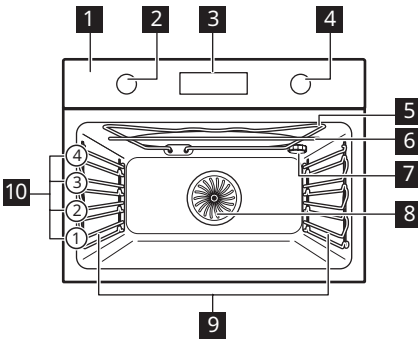

- 1 Panel de mandos
- 2 Mando de las funciones de cocción
- 3 Programador electrónico
- 4 Mando de control
- 5 Resistencia
- 6 Generador de microondas
- 7 Bombilla
- 8 Ventilador
- 9 Soporte de parrilla extraíble
- 10 Posiciones de las parrillas

**Teclas**





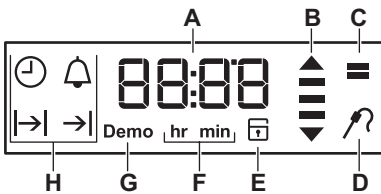





☑	▶+30	OK
Para ajustar las funciones de reloj. Para comprobar la temperatura del horno. Utilice únicamente si está activada una función de cocción.	Para iniciar una función de cocción. Pulse para prolongar la función de microondas 30 segundos.	Para confirmar.

**Pantalla**



- A. Temporizador / Temperatura / Potencia del microondas
- B. Indicador de calor residual y calentamiento
- C. Modo microondas
- D. Sonda térmica (solo en modelos seleccionados)
- E. Puerta bloqueada (solo los modelos seleccionados)
- F. Horas / minutos
- G. Modo demostración (solo en modelos seleccionados)
- H. Funciones de reloj

## Funciones de cocción

-  **Posición de apagado** El horno está apagado
-  **Cocción con aire forzado** Horneado uniforme, ternura, secado
-  **Convencional (calor superior e inferior)** Horneado tradicional
-  **Grill** Grill, tostar
-  **Aire caliente + microondas** Horneado
-  **Cocción convencional + micro** Horneado, asado
-  **Grill + microondas** Cocinar / dorar.
-  **Microondas** Calentamiento, cocción, potencia: 100 - 1.000 W
-  **Líquidos** Calentar bebidas y sopas, potencia: 800 - 1.000 W
-  **Descongelar** Descongelar carne, pescado, pasteles, potencia: 100 - 200 W
-  **Recalentar** Calentar comidas preparadas y delicadas, rango de potencia: 300 - 700 W

## Recipientes y materiales adecuados para microondas

Para el microondas, utilice solo utensilios y materiales adecuados. Consulte la tabla siguiente como referencia.

Compruebe los utensilios de cocina / especificación de materiales antes de utilizarlo.

Material del utensilio de cocina	Función microondas		Función microondas Combi p. ej., 
	Descongelar	Calentar, Cocción	
Cristal y porcelana para horno sin componentes de metal, p. ej., vidrio térmico	✓	✓	✓
Vidrio y porcelana no aptos para horno sin plata, oro, platino ni decoraciones de metal	✓	X	X
Cristal y vitrocerámica de material apto para horno y congelación	✓	✓	✓
Cerámica y barro sin cuarzo ni componentes metálicos, o vidriado que contenga metales	✓	✓	X

Material del utensilio de cocina	Función microondas		Función microondas Combi p. ej., 
	Descongelar	Calentar, Cocción	
Cerámica, porcelana o barro cocido con fondo sin vidriar o con pequeños orificios, p. ej., en las asas	X	X	X
Plástico resistente al calor hasta 200 °C	✓	✓	X
Cartón, papel	✓	X	X
Película de cocción	✓	X	X
Film para asado con cierre apto para microondas	✓	✓	X
Fuentes de metal, como esmalte o hierro fundido	X	X	✓
Moldes, barniz negro o revestimiento de silicona	X	X	✓
Bandeja	X	X	X
Parrilla	X	X	✓
Plato inferior de cristal para microondas	✓	✓	X
Utensilios para microondas, p.ej., Crostino	X	✓	X

## Solución de problemas

Si tiene algún problema con el aparato, consulte el capítulo "Solución de problemas"

en la versión completa del manual del usuario disponible en: [www.ikea.com](http://www.ikea.com).

## Datos técnicos

Dimensiones (internas)	Ancho Alto Fondo	480 mm 217 mm 411 mm
Volúmenes útiles	43 L	
Área de la bandeja	1424 cm <sup>2</sup>	
Resistencia superior	1900 W	

Resistencia inferior	1000 W
Grill	1900 W
Anillo	1650 W
Potencia total	3000 W
Voltaje	220 - 240 V
Frecuencia	50 Hz
Número de funciones	10











867371849-A-332022

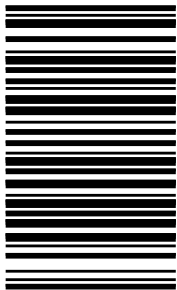

© Inter IKEA Systems B.V. 2022

21552

AA-2336028-2