

# KULINARISK

DK

NL

GB

FR

DE

IT

NO

PT

ES



Design and Quality  
IKEA of Sweden

<b>DANSK</b>	<b>6</b>
<b>NEDERLANDS</b>	<b>10</b>
<b>ENGLISH</b>	<b>14</b>
<b>FRANÇAIS</b>	<b>18</b>
<b>DEUTSCH</b>	<b>23</b>
<b>ITALIANO</b>	<b>27</b>
<b>NORSK</b>	<b>31</b>
<b>PORTUGUÊS</b>	<b>35</b>
<b>ESPAÑOL</b>	<b>39</b>

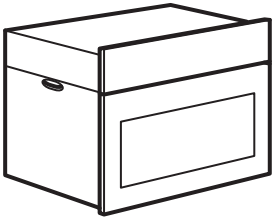
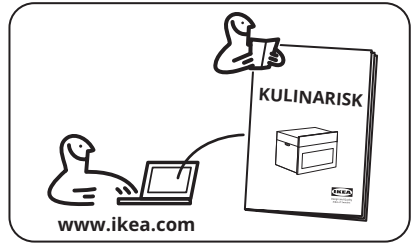
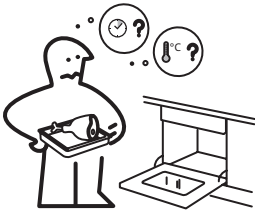

1x

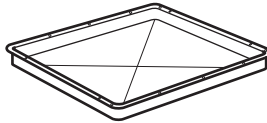

1x



1x



1x

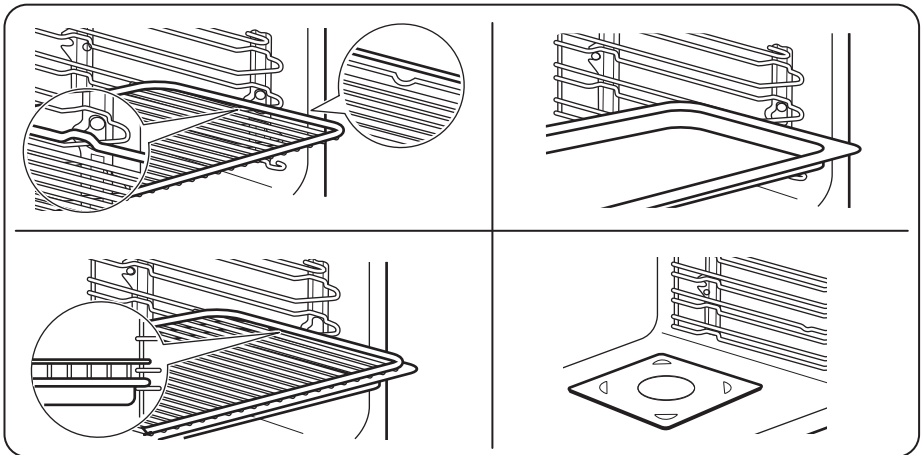

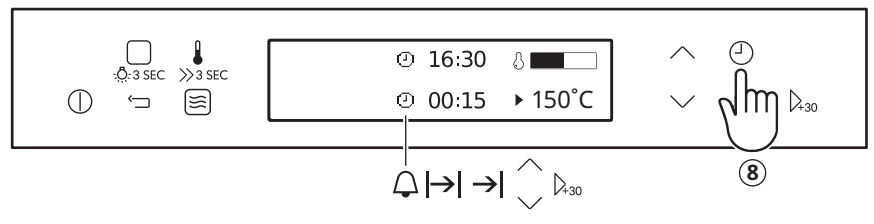
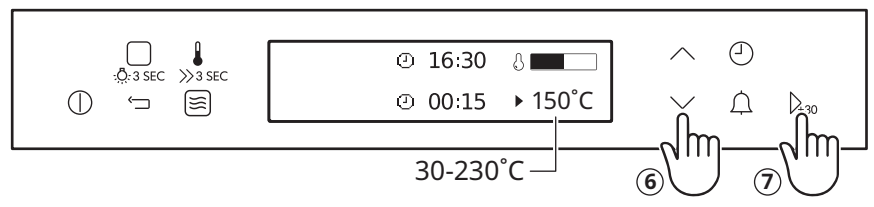
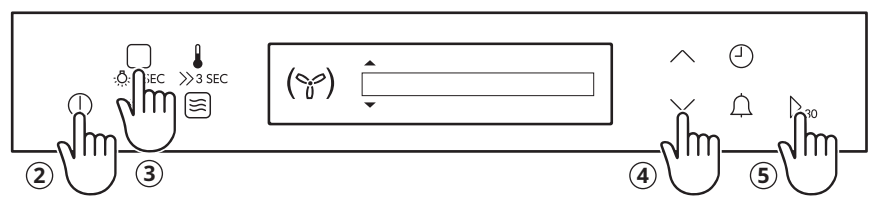
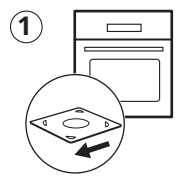
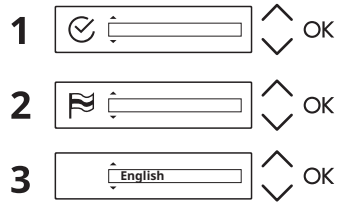
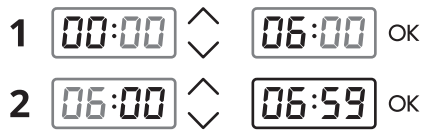
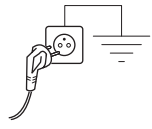

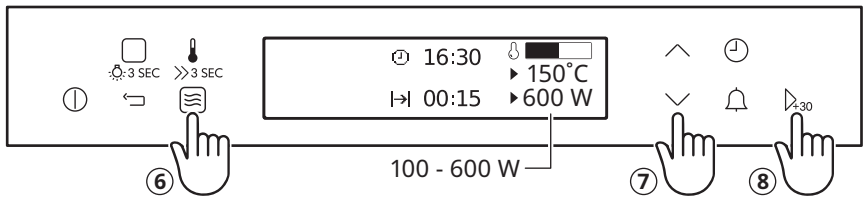
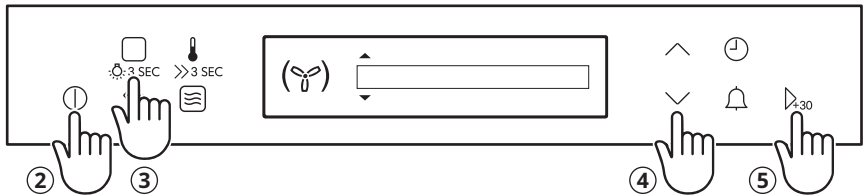
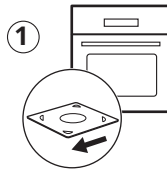
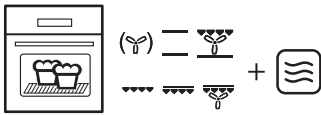
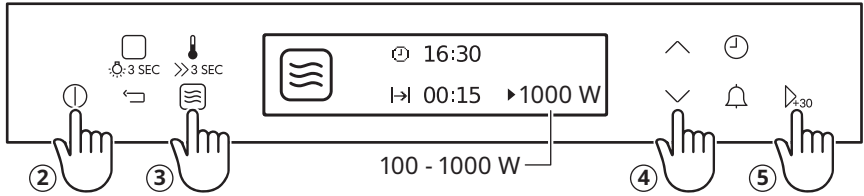
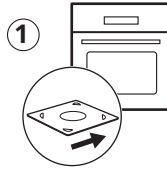

## Produktbeskrivelse

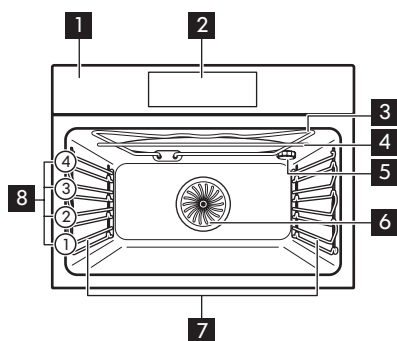

- 1** Betjeningspanel
- 2** Elektronisk programur
- 3** Grill
- 4** Mikrobølgegenerator
- 5** Ovn-pære
- 6** Blæser
- 7** Ovnribbe, udtagelig
- 8** Ovnriller

## Kontrolpanel

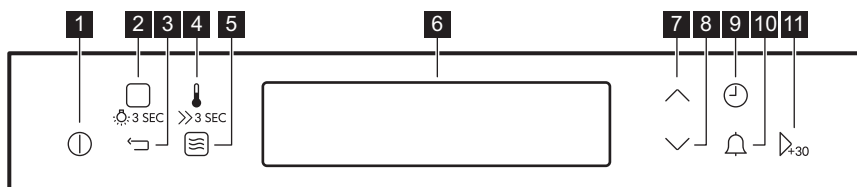

- 1** TÆND / SLUK
- 2** Ovnfunktioner / Hjælp Til Tilberedning / Lampe
- 3** Tilbage-tast
- 4** Temperatur / Hurtig opvarmning
- 5** Mikrobølge-funktion
- 6** Skærm
- 7** Pil op
- 8** Pil ned
- 9** Tid / Flere funktioner
- 10** Minutur
- 11** OK / hurtig start af mikrobølgeovn

## Skærm

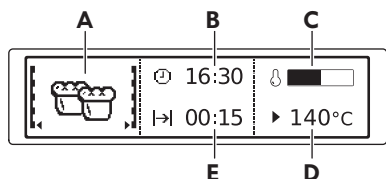

- A. Ovn- eller mikrobølgefunktion
- B. Aktuel tid
- C. Opvarmingsindikator
- D. Mikrobølgeovens temperatur eller effekt
- E. En funktions varighed og sluttidspunkt

Andre kontrollamper på displayet:

Symbol	Funktion
	Funktionen er tændt.
	Viser aktuel tid.
	Viser den krævede tilberedningstid.
	Viser tilberedningsvarighed.
	Viser temperaturen.
	Viser, hvornår den indstillede tilberedningstid er slut. Tryk på $\checkmark$ og $\wedge$ samtidigt for at nulstille tiden.
	Angiver varmeniveauet i ovnen.
	Hurtig opvarmning er slået til.
	Viser, at vægtautomatikfunktionen er slået til, eller at du kan ændre vægtindstillingen
	Heat+Hold er tændt.

## Ovnfunktioner

	<b>Varmluft</b>	Jævn bagning, mørt kød, tørring
	<b>Over-/undervarme</b>	Traditionel bagning
	<b>Pizza-funktionen</b>	Pizza-bagning
	<b>Lavtemperaturstegning</b>	Til møre stege
	<b>Undervarme</b>	Bagning af kager
	<b>Frosne madvarer</b>	Til færdigretter (f.eks. pommes frites)
	<b>Grillstegning</b>	Grillstegning, ristning
	<b>Hurtig grillstegning</b>	Grillstegning af store portioner, ristning
	<b>Turbogrill</b>	Stegning af kød, brunng

## Specialprogrammer



Brød



Gratiner



Hævning af dej



Tallerkenvarmer



Henkogning



Tørring



Holde varm



Optøning

## Mikrobølgeegnet kogegrej og materialer

Kun kogegrej og materialer, der er velegnet til mikrobølge. Brug nedenstående tabel som reference.

Kontrollér kogegrejet/ materialespecifikationen inden brug.

Kogegrej/materiale	Mikrobølge-funktion		Mikrobølge/kombi-funktion
	Optøning	Varme, Tilberedning	
Ovnfast glas og porcelæn uden metal-komponenter, f.eks. ildfast glas	✓	✓	✓
Ikke-ovnfast glas og porcelæn uden sølv-, guld-, platin- eller andre metal-dekorationer	✓	X	X
Glas og glaskeramik lavet af ovnfast/ frostsikkert materiale	✓	✓	✓
Keramik og lertøj uden kvarts eller metal-komponenter og glaseringer, som indeholder metal	✓	✓	X
Keramik, porcelæn og lertøj med uglaseret bund eller med små huller, f.eks. på håndtag	X	X	X
Varmebestandig plast op til 200 °C	✓	✓	X
Karton, papir	✓	X	X
Film	✓	X	X
Stegefilm med lukning, der er beregnet til mikrobølge	✓	✓	X
Stegning af metal, f.eks. emalje, støbejern	X	X	✓
Bageforme, sort lak eller silikonebe-lagt	X	X	✓
Bageplade	X	X	X



Kogegrej/materiale	Mikrobølge-funktion		Mikrobølge/kombi-funktion
	Optøning	Varme, Tilberedning	
Grillrist	X	X	✓
Bundplade af glas i mikroovn	✓	✓	X
Kogegrej til mikrobølge, f.eks. fad	X	✓	X

## Fejlfinding

Hvis du støder på et problem med dit apparat, kan du se kapitlet "Fejlfinding" i den

fulde version af brugervejledningen, som findes på: [www.ikea.com](http://www.ikea.com).

## Tekniske data

Mål (indvendigt)	Bredde Højde Dybde	480 mm 217 mm 411 mm
Brugbare mængder	43 l	
Område til bageplade	1424 cm <sup>2</sup>	
Øverste varmelegeme	1900 W	
Nederste varmelegeme	1000 W	
Grill	1900 W	
Kreds	1650 W	
Effekt i alt	3000 W	
Spænding	220 - 240 V	
Frekvens	50 Hz	
Antal funktioner	17	

**Productbeschrijving**

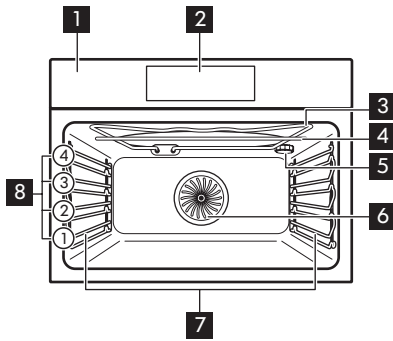

- 1** Bedieningspaneel
- 2** Elektronische tijdschakelklok
- 3** Grillen
- 4** Magnetrongenerator
- 5** Lamp
- 6** Ventilator
- 7** Inschuifrails, verwijderbaar
- 8** Inzetniveaus

**Bedieningspaneel**

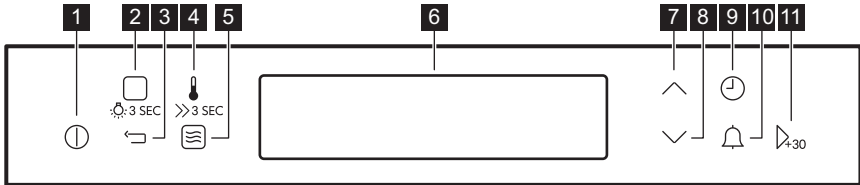

- 1** AAN/UIT
- 2** Verwarmingsfuncties / Kook- En Bakassistent / Lampje
- 3** Toets op de achterkant
- 4** Temperatuur / Snel opwarmen
- 5** Magnetronfunctie
- 6** Display
- 7** Toets Omhoog
- 8** Toets Omlaag
- 9** Tijd / Meer functies
- 10** Kookwekker
- 11** OK / Magnetron snel starten

Display

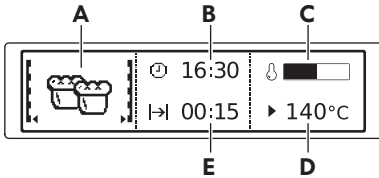

- A. Verwarmingsfunctie of magnetronfunctie
- B. Dagtijd
- C. Indicatielampje bij voorverwarmen
- D. Temperatuur of vermogen van de magnetron
- E. Duur of eindtijd van een functie



Andere informatie op het display:



Symbol	Functie
	De functie is ingeschakeld.
	Toont de huidige tijd.
	Toont de benodigde bereidingstijd.
	Toont de bereidingsduur.
	Geeft de temperatuur weer.
	Toont wanneer de ingestelde bereidingstijd eindigt. Druk tegelijkertijd op ^ and v om de tijd te resetten.
	Geeft het warmteniveau in de oven aan.
	Snel opwarmen staat aan.
	Geeft aan dat de functie "Per gewicht" aanstaat, of dat u de gewichtsinstelling kunt wijzigen
	Heat + Hold (Warmte + vasthouden) staat aan.

Verwarmingsfuncties



- Hotelucht** Zelfs bakken, malsheid, drogen
- Boven + onderwarmte** Traditioneel bakken
- Pizza-functie** Pizza bakken
- Lage temperatuur garen** Voor malse braadstukken
- Onderwarmte** Baktaarten
- Bevroren gerechten** Voor kant-en-klare gerechten (bijv. patat)
- Grillen** Grillen, roosteren
- Intens grillen** Grote porties grillen, roosteren
- Circulatiegrill** Braadvlees, bruining

**Speciaal**

 **Brood bakken**  
 **Gratineren**

 **Deeg laten rijzen**  
 **Borden warmen**

 **Inmaken**  
 **Drogen**

 **Warm houden**  
 **Ontdooien**

**Kookgerei en materialen geschikt voor de magnetron**

Gebruik alleen kookgerei en materiaal in de magnetron dat hier geschikt voor is. Gebruik onderstaande tabel als referentie.

Controleer de specificaties van het kookgerei/materiaal voor gebruik.

Kookgerei/materiaal	Magnetronfunctie		Combimagnetronfunctie
	Ontdooien	Opwarmen, Koken	
Ovenvast glas en porselein zonder metalen onderdelen, bijv. hittebestendig glas	✓	✓	✓
Niet-ovenbestendig glas en porselein zonder zilveren, gouden, platina of andere metalen versieringen	✓	X	X
Glas en glaskeramiëk van ovenbestendig / diepvriesbestendig materiaal	✓	✓	✓
Keramiëk en aardewerk zonder kwarts of metalen onderdelen en metaalhoudend glazuur	✓	✓	X
Keramiëk, porselein en aardewerk met ongeglazuurde onderkant of met kleine gaatjes, bijv. op handvaten	X	X	X
Tot 200 °C hittebestendige kunststof	✓	✓	X
Karton, papier	✓	X	X
Huishoudfolie	✓	X	X
Ovenfolie met magnetronveilige sluiting	✓	✓	X
Braadschalen gemaakt van metaal, bijv. email, gietijzer	X	X	✓
Bakblikken, zwarte lak of met siliconen coating	X	X	✓

Kookgerei/materiaal	Magnetronfunctie		Combimagnetronfunctie
	Ontdooien	Opwarmen, Koken	
Bakplaat	X	X	X
Bakrooster	X	X	✓
Glazen bodemplaat magnetron	✓	✓	X
Kookgerei voor gebruik in magnetron, bijv. pan voor knapperige gerechten	X	✓	X

## Probleemoplossing

Als u op een probleem met uw apparaat stuit, raadpleeg dan het hoofdstuk "Probleemoplossing" in de volledige versie

van de gebruikershandleiding, beschikbaar op: [www.ikea.com](http://www.ikea.com).

## Technische gegevens

Afmetingen (intern)	Breedte Hoogte Diepte	480 mm 217 mm 411 mm
Bruikbare volumes	43 l	
Plaats bakplaat	1424 cm <sup>2</sup>	
Bovenste verwarmingselement	1900 W	
Onderste verwarmingselement	1000 W	
Grillen	1900 W	
Ring	1650 W	
Totale beoordeling	3000 W	
Spanning	220 - 240 V	
Frequentie	50 Hz	
Aantal functies	17	

### Product Description

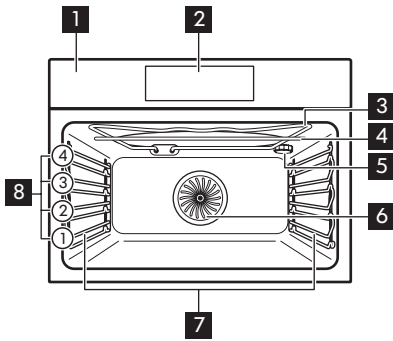

- 1** Control panel
- 2** Electronic programmer
- 3** Grill
- 4** Microwave generator
- 5** Lamp
- 6** Fan
- 7** Shelf support, removable
- 8** Shelf positions

### Control Panel

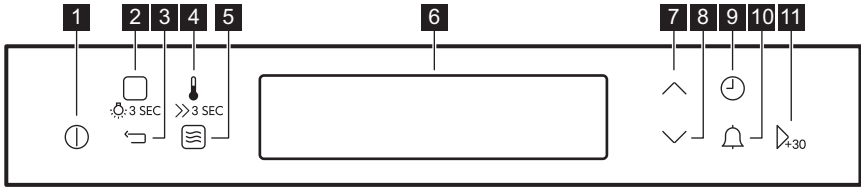

- 1** ON / OFF
- 2** Heating Functions / Assisted Cooking / Lamp
- 3** Back key
- 4** Temperature / Fast Heat Up
- 5** Microwave function
- 6** Display
- 7** Up key
- 8** Down key
- 9** Time / More functions
- 10** Minute minder
- 11** OK / Microwave Quick Start

**Display**

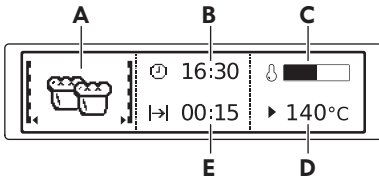

- A. Heating function or Microwave function
- B. Time of day
- C. Heat-up indicator
- D. Temperature or power of the microwave
- E. Duration time or end time of a function



Other indicators of the display:

Symbol	Function
	The function is on.
	Shows current time.
	Shows the necessary time for cooking.
	Shows cooking duration.
	Shows the temperature.
	Shows when the set cooking time ends. Press $\vee$ and $\wedge$ at the same time to reset the time.
	Indicates heat level in the oven.
	Fast Heat Up is on.
	Shows that Weight Automatic function is on, or that you can change the weight setting
	Heat + Hold is on.



**Heating Functions**

- True Fan Cooking** Even baking, tenderness, drying
- Conventional Cooking** Traditional baking
- Pizza Function** Baking pizza
- Slow Cooking** For tender roasts
- Bottom Heat** Baking cakes
- Frozen Foods** For convenience food (e.g. french fries)
- Grill** Grilling, toasting
- Fast Grilling** Grilling big portions, toasting
- Turbo Grilling** Roasting meat, browning

**Specials**

 **Bread Baking**  
 **Au Gratin**

 **Dough Proving**  
 **Plate Warming**

 **Preserving**  
 **Dehydrating**

 **Keep Warm**  
 **Defrost**

**Microwave suitable cookware and materials**

For the microwave use only suitable cookware and materials. Use below table as a reference.

Check the cookware / material specification before use.

Cookware / Material	Microwave function		Microwave Combi function
	Defrosting	Heating, Cooking	
Ovenproof glass and porcelain with no metal components, e.g. heat-proof glass	✓	✓	✓
Non-ovenproof glass and porcelain without any silver, gold, platinum or other metal decorations	✓	X	X
Glass and glass ceramic made of ovenproof / frost-proof material	✓	✓	✓
Ceramic and earthenware without any quartz or metal components and glazes which contain metal	✓	✓	X
Ceramic, porcelain and earthenware with unglazed bottom or with small holes, e.g. on handles	X	X	X
Heat-resistant plastic up to 200 °C	✓	✓	X
Cardboard, paper	✓	X	X
Clingfilm	✓	X	X
Roasting film with microwave safe closure	✓	✓	X
Roasting dishes made of metal, e.g. enamel, cast iron	X	X	✓
Baking tins, black lacquer or silicon-coated	X	X	✓



Cookware / Material	Microwave function		Microwave Combi function
	Defrosting	Heating, Cooking	
Baking tray	X	X	X
Wire shelf	X	X	✓
Microwave glass bottom plate	✓	✓	X
Cookware for microwave use, e.g. crisp pan	X	✓	X

## Troubleshooting

If you encounter an issue with your appliance, check "Troubleshooting" chapter

in the full version of the User Manual available on: [www.ikea.com](http://www.ikea.com).

## Technical data

Dimensions (internal)	Width Height Depth	480 mm 217 mm 411 mm
Usable volumes	43 l	
Area of baking tray	1424 cm <sup>2</sup>	
Top heating element	1900 W	
Bottom heating element	1000 W	
Grill	1900 W	
Ring	1650 W	
Total rating	3000 W	
Voltage	220 - 240 V	
Frequency	50 Hz	
Number of functions	17	

## Description de l'appareil

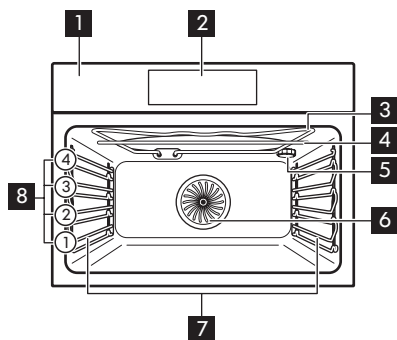

- 1** Bandeau de commande
- 2** Programmateur électronique
- 3** Gril
- 4** Générateur de micro-ondes
- 5** Éclairage
- 6** Chaleur tournante
- 7** Support de grille, amovible
- 8** Niveaux de la grille

## Bandeau de commande

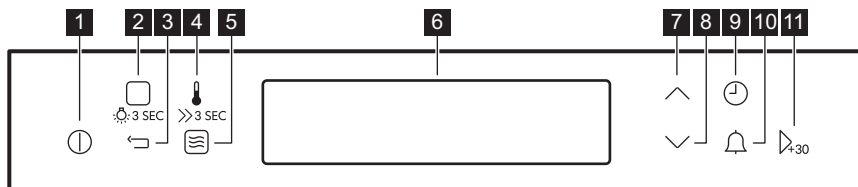

- 1** MARCHE / ARRÊT
- 2** Modes de cuisson / Cuisson Assistée / Éclairage
- 3** Touche Retour
- 4** Température / Préchauffage rapide
- 5** Fonction micro-ondes
- 6** Affichage
- 7** Touche Haut
- 8** Touche Bas
- 9** Heure / Plus de fonctions
- 10** Minuteur
- 11** OK / Départ rapide micro-ondes

## Affichage

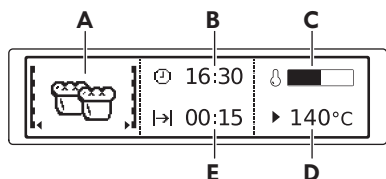

- A. Mode de cuisson ou fonction micro-ondes
- B. Heure actuelle
- C. Indicateur de préchauffage
- D. Température ou puissance du micro-ondes
- E. Durée ou heure de fin d'une fonction









Autres indicateurs de l'affichage :

Symbole	Fonction
	La fonction est activée.
	Affiche l'heure actuelle.
	Affiche le temps de cuisson nécessaire.
	Affiche la durée de cuisson.
	Affiche la température.
	Affiche la fin du temps de cuisson. Appuyez simultanément sur $\checkmark$ et $\wedge$ pour réinitialiser la durée.
	Indique le niveau de chaleur du four.
	La fonction Préchauffage rapide est activée.
	Indique que la fonction de poids automatique est activée ou que le poids entré peut être modifié.
	La fonction Maintien au chaud est activée.

## Modes de cuisson

- Chaleur tournante** Cuisson homogène, tendreté, séchage
- Chauffage Haut/Bas** Cuisson traditionnelle
- Fonction Pizza** Cuisson de pizza
- Cuisson basse température** Pour des rôtis tendres
- Cuisson de sole** Cuisson de gâteaux
- Plats Surgelés** Pour les plats préparés tels que les frites
- Gril** Griller, toaster
- Gril rapide** Faire griller de grosses portions, rôtir
- Turbo gril** Rôtir la viande, faire dorer

## Programmes spéciaux

 Cuisson du pain	 Levée de pâte/ pain	 Stérilisation	 Maintien au chaud
 Gratin	 Chauffe-plats	 Déshydratation	 Décongélation

## Ustensiles de cuisine et matériaux adaptés aux micro-ondes

Pour la cuisson au micro-ondes, n'utilisez que des récipients et matériaux adaptés. Utilisez le tableau ci-dessous comme référence.

Vérifiez les caractéristiques des ustensiles de cuisine / des matériaux avant utilisation.

Ustensiles de cuisine / Matériaux	Fonction micro-ondes		Fonction combi Micro-ondes
	Décongélation	Réchauffage, Cuisson	
Verre et porcelaine allant au four ne contenant aucun composant métallique, par ex. le verre résistant à la chaleur	✓	✓	✓
Verre et porcelaine n'allant pas au four sans décor en argent, or, platine ou métal	✓	X	X
Verre et vitrocéramique en matériau résistant aux températures élevées/basses	✓	✓	✓
Récipients en céramique et en faïence sans composant en quartz ou en métal, ni vernis contenant du métal	✓	✓	X
Céramique, porcelaine et faïence dont le fond n'est pas verni ou avec de petits trous, par exemple sur les poignées	X	X	X
Plastique résistant à la chaleur jusqu'à 200 °C	✓	✓	X
Carton, papier	✓	X	X
Film étirable	✓	X	X

Ustensiles de cuisine / Matériaux	Fonction micro-ondes		Fonction combi Micro-ondes
	Décongélation	Réchauffage, Cuisson	
Sachet de cuisson avec fermeture de sûreté pour micro-ondes	✓	✓	X
Plats à rôtir en métal, par ex. en émail, en fonte	X	X	✓
Moules à gâteaux, laqués noirs ou avec revêtement en silicone	X	X	✓
Plateau de cuisson	X	X	X
Grille métallique	X	X	✓
Plateau en verre du micro-ondes	✓	✓	X
Ustensiles pour une utilisation au micro-ondes, par ex. plat pour cuisson croustillante	X	✓	X

## Dépannage

Si vous rencontrez un problème avec votre appareil, consultez le chapitre « Dépannage » dans la version complète du

Manuel de l'utilisateur disponible sur : [www.ikea.com](http://www.ikea.com).

## Données techniques

Dimensions (internes)	Largeur Hauteur Profondeur	480 (mm) 217 (mm) 411 (mm)
Volumes utilisables	43 l	
Zone du plateau de cuisson	1424 cm <sup>2</sup>	
Chauffage de voûte	1900 W	
Chauffage de sole	1000 W	
Gril	1900 W	
Circuit	1650 W	
Puissance totale	3000 W	
Tension	220 - 240 V	

Fréquence	50 Hz
Nombre de fonctions	17

### Produktbeschreibung

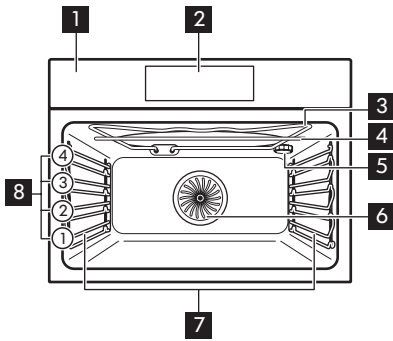

- 1 Bedienfeld
- 2 Elektronischer Programmspeicher
- 3 Grill
- 4 Mikrowellengenerator
- 5 Lampe
- 6 Ventilator
- 7 Einschubschienen, herausnehmbar
- 8 Einschubebenen

### Bedienfeld

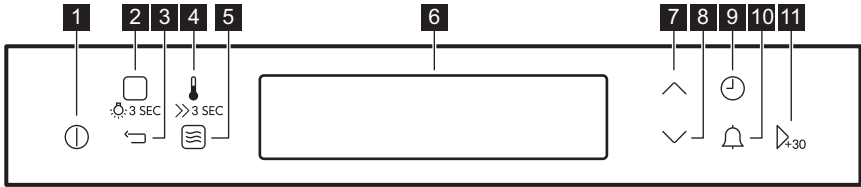

- 1 EIN / AUS
- 2 Ofenfunktionen / Koch-Assistent / Lampe
- 3 Zurück-Taste
- 4 Temperatur / Schnellaufheizung
- 5 Mikrowellenfunktion
- 6 Display
- 7 Schlüssel nach oben
- 8 Schlüssel nach unten
- 9 Zeit / Mehr Funktionen
- 10 Kurzzeit-Wecker
- 11 OK / Mikrowellen-Schnellstart

## Anzeige

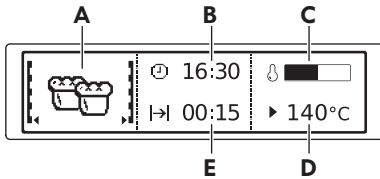

- A. Funktion Heizung oder Mikrowelle
- B. Uhrzeit
- C. Aufheiz-Anzeige
- D. Temperatur oder Leistung der Mikrowelle
- E. Dauer oder Endzeit einer Funktion

Weitere Anzeigen auf dem Display:

Symbol	Funktion
	Die Funktion ist eingeschaltet.
	Zeigt die aktuelle Zeit an.
	Zeigt die notwendige Zeit zum Kochen an.
	Zeigt die Dauer des Kochens an.
	Zeigt die Temperatur an.
	Zeigt an, wann die eingestellte Garzeit endet. Drücken Sie $\vee$ und $\wedge$ gleichzeitig, um die Zeit zurückzusetzen.
	Zeigt den Wärmestand im Ofen an.
	Schnelles Aufheizen ist eingeschaltet.
	Zeigt an, dass die Funktion Gewichtsautomatik eingeschaltet ist oder dass Sie die Gewichtseinstellung ändern können
	Hitze + Halten ist eingeschaltet.



## Ofenfunktionen



- Heißluft** Gleichmäßiges Backen, Zartheit, Dörren
- Ober-/Unterhitze** Traditionelles Backen
- Pizzastufe** Backen von Pizza
- Niedertemperaturgaren** Für zarte Braten
- Unterhitze** Kuchen backen
- Tiefkühlgerichte** Für Fertiggerichte (z.B. Französisch Pommes frites)
- Grill** Grillen, Braten
- Schnelles Grillen** Grillen großer Portionen, Toasten
- Heißluftgrillen** Braten von Fleisch, Bräunen

Die Vollversion kann unter [www.ikea.com](http://www.ikea.com) heruntergeladen werden.





## Sonderfunktionen

 Brot backen  
 Überbacken

 Gärstufe  
 Teller wärmen

 Einkochen  
 Dörren

 Warmhalten  
 Auftauen

## Mikrowellengeeignetes Kochgeschirr und Materialien

Verwenden Sie nur mikrowellengeeignetes Kochgeschirr und Materialien. Verwenden Sie die folgende Tabelle als Referenz.

Prüfen Sie vor der Verwendung die Kochgeschirr- und Materialspezifikationen.

Kochgeschirr / Material	Mikrowellenfunktion		Mikrowellen-Kombifunktion
	Auftauen	Erwärmen, Kochen	
Feuerfestes Glas und Porzellan ohne Metallteile, z. B. hitzebeständiges Glas	✓	✓	✓
Nicht feuerfestes Glas und Porzellan ohne Verzierung aus Silber, Gold, Platin oder Metall	✓	X	X
Glas und Glaskeramik aus hitze-/frostbeständigem Material	✓	✓	✓
Keramik und Steingut ohne Quarz- oder Metallteile oder metallhaltige Glasur	✓	✓	X
Keramik, Porzellan und Steingut mit unglasiertem Boden oder mit kleinen Löchern, z. B. auf den Griffen	X	X	X
Hitzebeständiger Kunststoff bis 200 °C	✓	✓	X
Pappe, Papier	✓	X	X
Frischhaltefolie	✓	X	X
Bratfolie mit mikrowellengeeignetem Verschluss	✓	✓	X
Bratgeschirr aus Metall, z. B. Emaille, Gusseisen	X	X	✓
Backformen, schwarz lackiert oder silikonbeschichtet	X	X	✓
Backblech	X	X	X

Kochgeschirr / Material	Mikrowellenfunktion		Mikrowellen-Kombi- funktion
	Auftauen	Erwärmen, Kochen	
Gitterrost	X	X	✓
Mikrowellen-Bodenplatte aus Glas	✓	✓	X
Kochgeschirr für die Mikrowelle, z. B. Knusperpfanne	X	✓	X

## Problembhebung

Wenn Sie ein Problem mit Ihrem Gerät haben, lesen Sie das Kapitel „Fehlerbehebung“ in der Vollversion des

Benutzerhandbuchs, das auf folgenden Seiten verfügbar ist: [www.ikea.com](http://www.ikea.com).

## Technische Daten

Abmessungen (intern)	Breite Höhe Tiefe	480 mm 217 mm 411 mm
Nutzbare Volumen	43 l	
Backblechgröße	1424 cm <sup>2</sup>	
Oberes Heizelement	1900 W	
Unteres Heizelement	1000 W	
Grill	1900 W	
Ring	1650 W	
Gesamtbewertung	3000 W	
Spannung	220 - 240 V	
Frequenz	50 Hz	
Anzahl der Funktionen	17	

## Descrizione del prodotto

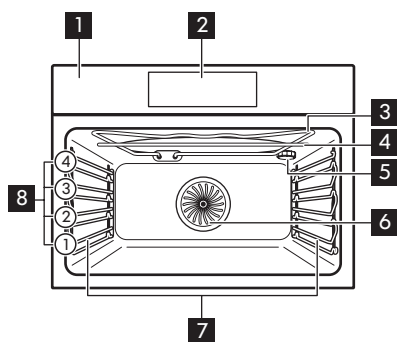

- 1** Pannello dei comandi
- 2** Programmatore elettronico
- 3** Grill
- 4** Generatore microonde
- 5** Lampadina
- 6** Ventola
- 7** Supporto ripiano, rimovibile
- 8** Posizioni ripiano

## Pannello dei comandi

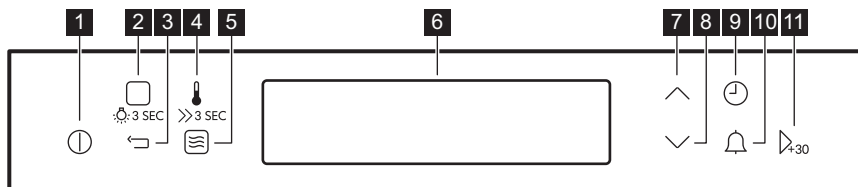

- 1** ON/OFF
- 2** Funzioni cottura / Cottura Guidata / Lampada
- 3** Tasto indietro
- 4** Temperatura / Riscaldamento rapido
- 5** Funzione microonde
- 6** Display
- 7** Tasto Su
- 8** Tasto Giù
- 9** Ora/Altre funzioni
- 10** Contaminuti
- 11** OK/Avvio rapido del microonde

## Display

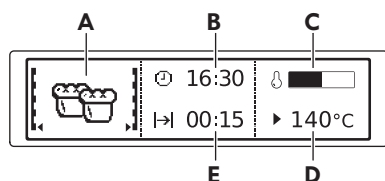

- A. Funzione cottura o funzione microonde
- B. Imposta ora
- C. Indicatore di riscaldamento
- D. Temperatura o potenza del microonde
- E. Durata od orario fine di una funzione

Altri indicatori del display:

Simbolo	Funzione
	La funzione è attiva.
	Mostra l'ora corrente.
	Mostra il tempo necessario per la cottura.
	Mostra la durata della cottura.
	Mostra la temperatura.
	Mostra quando finisce il tempo di cottura impostato. Premere contemporaneamente $\checkmark$ e $\wedge$ per reimpostare l'ora.
	Indica il livello di calore nel forno.
	Il riscaldamento rapido è attivo.
	Mostra che la funzione Peso automatico è attiva o che è possibile modificare l'impostazione del peso
	Pronto da servire è attivo.

## Funzioni cottura

	<b>Cottura ventilata</b>	Cottura omogenea, tenerezza, essiccazione
	<b>Cottura convenzionale</b>	Cottura tradizionale
	<b>Funzione Pizza</b>	Preparazione della pizza
	<b>Cottura lenta</b>	Per arrosti teneri
	<b>Resistenza inferiore</b>	Preparazione di dolci da forno
	<b>Cibi congelati</b>	Per cibo confezionato (ad es. patatine fritte)
	<b>Grill</b>	Cottura alla griglia, tostatura
	<b>Grill rapido</b>	Tostatura e cottura al grill di grandi porzioni
	<b>Doppio grill ventilato</b>	Arrostire carne, rosolare

## Funzioni speciali

— Cottura Pane

(☞) Lievitazione pasta

— Marmellate/  
Conserve

— Mantieni caldo

☞ Gratinato

(☞) Riscaldamento  
piatti

(☞) Essiccazione

(☞) Scongelamento

## Pentole e materiali adatti per un uso in microonde

Per il microonde usare solo tegami e materiali adeguati. Usare la seguente tabella come riferimento.

Controllare le specifiche delle pentole/del materiale prima dell'uso.

Pentole / Materiale	Funzione microonde		Funzione microonde combo
	Scongela- mento	Riscaldamen- to, Cottura	
Vetro e porcellana termoresistente (senza componenti metallici, ad es. vetro a prova di calore)	✓	✓	✓
Vetro e porcellana non resistente al fuoco senza applicazioni o decorazioni in argento, oro, platino o metallo	✓	X	X
Vetro e vetroceramica in materiale resistente al fuoco / al gelo	✓	✓	✓
Articoli in ceramica e terracotta, senza componenti al quarzo o componenti metalliche e smalti che contengono metallo	✓	✓	X
Ceramica, porcellana e oggetti di terracotta con parte inferiore non in vetro o con fori piccoli, ad esempio sulle maniglie	X	X	X
Plastica termoresistente fino a 200 °C	✓	✓	X
Cartoncino, carta	✓	X	X
Pellicola	✓	X	X
Sacchetti di cottura con chiusura adatta alle microonde	✓	✓	X

Pentole / Materiale	Funzione microonde		Funzione microonde combo
	Scongela- mento	Riscaldamen- to, Cottura	
Piatti per arrosto in metallo, ad es. smalto, ghisa	X	X	✓
Teglie laccate in nero o rivestite in silicone	X	X	✓
Lamiera dolci	X	X	X
Ripiano a filo	X	X	✓
Piatto inferiore in vetro del microonde	✓	✓	X
Pentole che possono essere usate in microonde, ad esempio piatto crisp	X	✓	X

## Risoluzione dei problemi

In caso di problemi con l'apparecchiatura consultare il capitolo "Risoluzione dei problemi" nella versione completa del

Manuale d'uso disponibile su:  
[www.ikea.com](http://www.ikea.com).

## Dati tecnici

Dimensioni (interne)	Larghezza Altezza Profondità	480 mm 217 mm 411 mm
Volumi utilizzabili	43 l	
Area della lamiera dolci	1424 cm <sup>2</sup>	
Resistenza superiore	1900 W	
Resistenza inferiore	1000 W	
Grill	1900 W	
Anello	1650 W	
Valutazione totale	3000 W	
Tensione	220 - 240 V	
Frequenza	50 Hz	
Numero di funzioni	17	

## Produktbeskrivelse

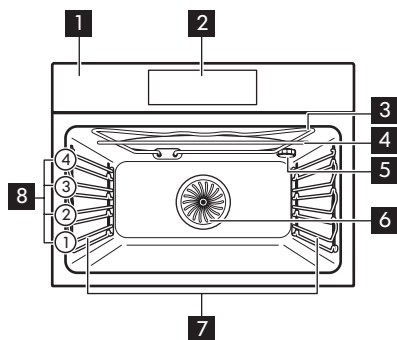

- 1** Betjeningspanel
- 2** Elektronisk programmering
- 3** Grill
- 4** Mikrobølgegenerator
- 5** Lys
- 6** Vifte
- 7** Uttakbare brettstiger
- 8** Hyllnivåer

## Betjeningspanel

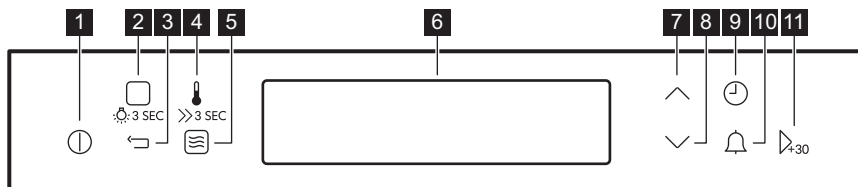

- 1** PÅ/AV
- 2** Ovnfunksjoner / Tilberedningshjelp / Lampe
- 3** Tilbake-tast
- 4** Temperatur / Hurtigoppvarming
- 5** Mikrobølge funksjon
- 6** Display
- 7** Opp-tast
- 8** Ned-tast
- 9** Tid / flere funksjoner
- 10** Varselur
- 11** OK / hurtigstart for mikrobølgeovn

## Display

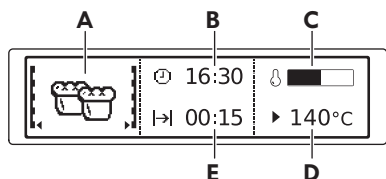

- A. Ovnfunksjon eller mikrobølgefunksjon
- B. Klokkeslett
- C. Oppvarmingsindikator
- D. Temperatur eller effekt til mikrobølgeovnen
- E. Varighet eller sluttid for en funksjon

Andre indikatorer på displayet:

Symbol	Funksjon
	Funksjonen er på.
	Viser gjeldende klokkeslett.
	Viser den nødvendige tilberedningstiden.
	Viser tilberedningvarighet.
	Viser temperaturen.
	Viser når den innstilte tilberedningstiden er over. For å tilbakestille tiden, trykk $\vee$ og $\wedge$ samtidig.
	Angir varmenivået i ovnen.
	Hurtigoppvarming er på.
	Viser at funksjonen Vektautomatikk er på, eller at du kan endre vektinnstillingen
	Heat + Hold er på.

## Ovnfunksjoner

	<b>Steking - ekte varmluft</b>	Tilberedning, mørhet, tørking
	<b>Over- og undervarme</b>	Tradisjonell steking
	<b>Pizzafunksjon</b>	Lage pizza
	<b>Langtidssteking</b>	For møre steker
	<b>Undervarme</b>	Steking av kaker
	<b>Frossen mat</b>	For lettvinnt mat (f.eks. pommes frites)
	<b>Grill</b>	Grilling, risting
	<b>Rask grilling</b>	Grilling av store porsjoner, risting
	<b>Gratinerer med vifte</b>	Steke kjøtt, bruning



## Spesialiteter

— Brødbaking  
 — Grateng

(☞) Deigheving

(☞)

Tallerkenoppvarming

— Hermetisering

(☞) Tørking

— Hold varm

(☞) Tining

## Egnede kokekar og materialer for mikrobølgeovn

Bruk bare egnede kokekar og materialer i mikrobølgeovnen. Bruk tabellen nedenfor som referanse.

Sjekk spesifikasjonene for kokekar/materiale før bruk.

Kokekar/materiale	Mikrobølgeovnfunksjon		Mikrobølgeovnens kombifunksjon
	Tining	Oppvarming, Tilberedning	
Ildfast glass og porselen uten metall-deler, f.eks. varmefast glass	✓	✓	✓
Ikke-ildfast glass og porselen uten sølv-, gull-, platina- eller metallbelegg/dekor	✓	X	X
Glass og glasskeramikk av ovns-/frost-sikkert materiale	✓	✓	✓
Keramikk og steintøy uten kvarts- eller metallkomponenter og glasur som inneholder metall	✓	✓	X
Keramikk, porselen eller steintøy som har uglassert bunn eller små hull, f.eks. på håndtaket	X	X	X
Varmebestandig plast opptil 200 °C	✓	✓	X
Papp, papir	✓	X	X
Plastfolie	✓	X	X
Stekefolie med lukking som er egnet for mikrobølgeovner	✓	✓	X
Stekeformer av metall, f.eks. emalje, støpejern	X	X	✓
Kakeformer, svartlakkerte eller silikon-belagte	X	X	✓

Kokekar/materiale	Mikrobølgeovnfunksjon		Mikrobølgeovnens kombifunksjon
	Tining	Oppvarming, Tilberedning	
Stekebrett	X	X	X
Rist	X	X	✓
Bunntallerken i glass for mikrobølgeovn	✓	✓	X
Kokekar for bruk i mikrobølgeovn, f.eks. ristpanne	X	✓	X

## Feilsøking

Hvis du støter på et problem med produktet, sjekk kapittelet "Feilsøking" i den

fullstendige versjonen av bruksanvisningen som er tilgjengelig på: [www.ikea.com](http://www.ikea.com).

## Tekniske data

Mål (innvendig)	Bredde Høyde Dybde	480 mm 217 mm 411 mm
Bruksvolum	43 l	
Stekebrett	1424 cm <sup>2</sup>	
Overelement	1900 W	
Undervarmeelementet	1000 W	
Grill	1900 W	
Ring	1650 W	
Total rangering	3000 W	
Spenning	220 - 240 V	
Frekvens	50 Hz	
Antall funksjoner	17	

## Descrição do produto

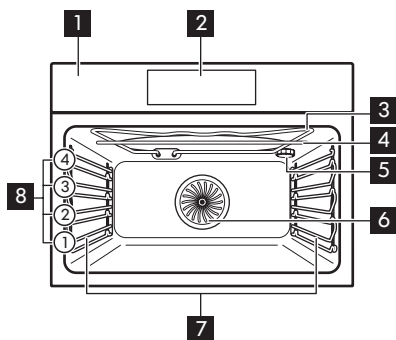

- 1 Painel de comandos
- 2 Programador eletrônico
- 3 Grelhador
- 4 Gerador de micro-ondas
- 5 Lâmpada
- 6 Ventilador
- 7 Apoio para prateleira, amovível
- 8 Nível das prateleiras

## Painel de comandos

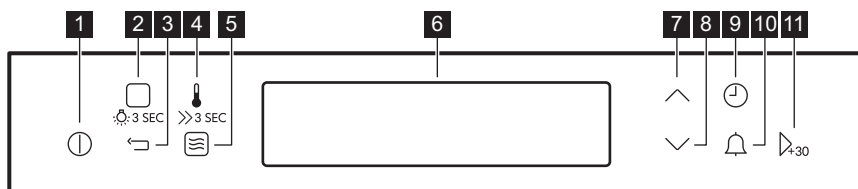

- 1 Ligar/Desligar
- 2 Funções de aquecimento / Cozedura Assistida / Lâmpada
- 3 Botão de voltar
- 4 Temperatura / Aquecimento rápido
- 5 Função microondas
- 6 Visor
- 7 Tecla para cima
- 8 Tecla para baixo
- 9 Tempo/Mais funções
- 10 Conta-minutos
- 11 Início rápido do micro-ondas



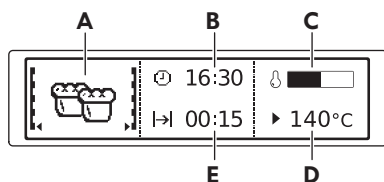







## Visor











- A. Tipo de aquecimento ou função de micro-ondas
- B. Hora
- C. Indicador de aquecimento.
- D. Temperatura ou potência do micro-ondas

**E. Tempo de duração e hora de fim de uma função**









Outros indicadores do visor:

Símbolo	Função
	A função está ativada.
	Apresenta a hora atual.
	Apresenta o tempo de cozedura necessário.
	Apresenta a duração da cozedura.
	Apresenta a temperatura.
	Apresenta quando o tempo de cozedura definido termina. Prima $\vee$ e $\wedge$ em simultâneo para reinicializar o tempo.
	Indica o nível de calor no forno.
	O aquecimento rápido está ligado.
	Mostra que a função Peso automático está ativa ou que pode alterar a definição do peso
	Manter Quente está ligado.

## Funções de aquecimento

-  **Aquecimento ventilador** Assado uniforme, tenro, seco
-  **Calor superior/inferior** Cozedura tradicional
-  **Função Pizza** Fazer pizza
-  **Aquecimento a baixa temp.** Para assados tenros
-  **Aquecimento inferior** Cozer bolos
-  **Congelados** Para comida caseira (por exemplo, batatas fritas)
-  **Grelhador** Grelhar, tostar
-  **Grelhador rápido** Grelhar porções grandes, tostar
-  **Grelhador ventilado** Assar carne, alourar

## Especiais

-  **Pão**
-  **Massa de pão**
-  **Conservar**
-  **Manter quente**
-  **Gratinado**
-  **Aquecer pratos**
-  **Secar**
-  **Descongelar**

## Recipientes e materiais adequados para micro-ondas

Utilize apenas materiais e recipientes adequados para micro-ondas quando utilizar a função de micro-ondas. Utilize a tabela em baixo como referência.

Verifique as especificações do recipiente/material antes da utilização.

Recipiente/Material	Função microondas		Função combinada de micro-ondas,
	Descongela	Aquecer, Cozinhar	
Porcelana e vidro próprios para forno, sem componentes metálicos, por exemplo, vidro à prova de calor	✓	✓	✓
Vidro e porcelana não adequados para forno, sem decorações em prata, ouro, platina ou outro metal	✓	X	X
Vidro e vitrocerâmica fabricados em material adequado para forno/congelador	✓	✓	✓
Cerâmica e barro sem componentes de quartzo ou metal, nem revestimentos que contenham metal	✓	✓	X
Cerâmica, porcelana ou barro com fundo não vidrado ou pequenos orifícios, por exemplo, nas pegas	X	X	X
Plástico resistente ao calor até 200 °C	✓	✓	X
Cartão, papel	✓	X	X
Película aderente	✓	X	X
Película própria para assados com fecho seguro para micro-ondas	✓	✓	X
Assadeiras em metal, por exemplo, esmalte, ferro fundido	X	X	✓
Formas para assar, com revestimento de silicone ou laca preta	X	X	✓
Tabuleiro para assar	X	X	X
Prateleira em grelha	X	X	✓
Prato de vidro do micro-ondas	✓	✓	X

Recipiente/Material	Função microondas		Função combinada de micro-ondas,
	Descongelar	Aquecer, Cozinhar	
Recipientes para utilizar em micro-ondas, por exemplo, uma frigideira de pega amovível	X	✓	X

## Resolução de problemas

Se tiver um problema com o seu aparelho, consulte o capítulo "Resolução de

problemas" na versão completa do Manual do Utilizador disponível em: [www.ikea.com](http://www.ikea.com).

## Informação técnica

Dimensões (interior)	Largura Altura Profundidade	480 mm 217 mm 411 mm
Volumes utilizáveis	43 l	
Área do tabuleiro para assar	1424 cm <sup>2</sup>	
Elemento de aquecimento superior	1900 W	
Elemento de aquecimento inferior	1000 W	
Grelhador	1900 W	
Anel	1650 W	
Potência total	3000 W	
Tensão	220 - 240 V	
Frequência	50 Hz	
Número de funções	17	

### Descripción del producto

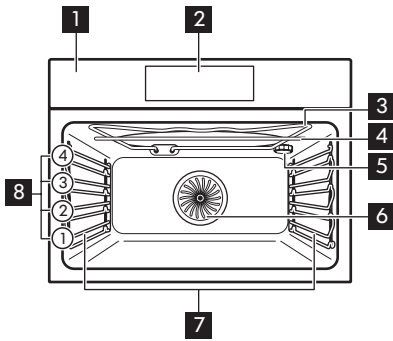

- 1 Panel de mandos
- 2 Pantalla
- 3 Grill
- 4 Generador de microondas
- 5 Bombilla
- 6 Ventilador
- 7 Soporte de parrilla extraíble
- 8 Posiciones de las parrillas

### Panel de mandos

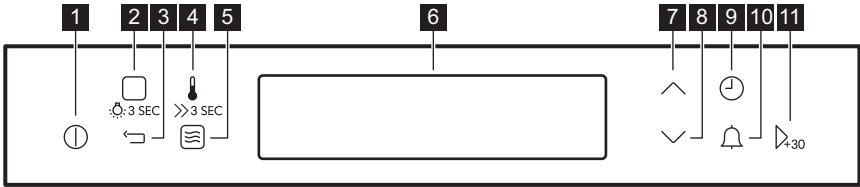

- 1 Encendido/Apagado
- 2 Funciones de cocción / Cocción Asistida / Lámpara
- 3 Teclas Atrás
- 4 Temperatura / Calentamiento rápido
- 5 Función microondas
- 6 Pantalla
- 7 Tecla Arriba
- 8 Tecla Abajo
- 9 Hora/Más funciones
- 10 Avisador
- 11 Aceptar/Inicio rápido del microondas

## Pantalla

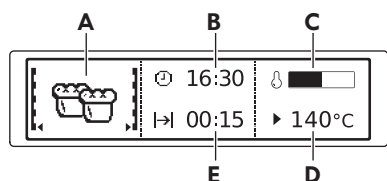

- A. Función de cocción o función de microondas
- B. Hora
- C. Indicador de calentamiento
- D. Temperatura o potencia del microondas
- E. Duración y hora de fin de una función

Otros indicadores de la pantalla:

Símbolo	Función
	La función está activada.
	Muestra la hora actual.
	Muestra el tiempo de cocción necesario.
	Muestra la duración de la cocción.
	Muestra la temperatura.
	Indica cuándo finaliza el tiempo de cocción programado. Pulse $\vee$ y $\wedge$ al mismo tiempo para restablecer el tiempo.
	Indica el nivel de temperatura del horno.
	El calentamiento rápido está activado.
	Indica que la función Peso automático está activada o que puede cambiar el ajuste del peso
	La función Calentar y mantener está activada.

## Funciones de cocción

	<b>Aire caliente</b>	Horneado uniforme, ternura, secado
	<b>Cocción convencional</b>	Horneado tradicional
	<b>Función pizza</b>	Hornear pizza
	<b>Cocción lenta</b>	Para asados tiernos
	<b>Calor inferior</b>	Hornear pasteles
	<b>Congelados</b>	Para comida precocinada (p. ej., patatas fritas)
	<b>Grill</b>	Grill, tostar
	<b>Grill rápido</b>	Cómo asar grandes porciones, cómo tostar
	<b>Grill turbo</b>	Asar carne, dorar



## Platos especiales

-  Horneado de pan  Leudar masas  Conservar  Mantener Caliente
-  Gratinar  Calientaplatos  Desecar alimentos  Descongelar

## Recipientes y materiales adecuados para microondas

Para el microondas, utilice solo utensilios y materiales adecuados. Consulte la tabla siguiente como referencia.

Compruebe los utensilios de cocina / especificación de materiales antes de utilizarlo.

Material del utensilio de cocina	Función microondas		Función microondas Combi
	Descongelar	Calentar, Cocción	
Cristal y porcelana para horno sin componentes de metal, p. ej., vidrio térmico	✓	✓	✓
Vidrio y porcelana no aptos para horno sin plata, oro, platino ni decoraciones de metal	✓	X	X
Cristal y vitrocerámica de material apto para horno y congelación	✓	✓	✓
Cerámica y barro sin cuarzo ni componentes metálicos, o vidriado que contenga metales	✓	✓	X
Cerámica, porcelana o barro cocido con fondo sin vidriar o con pequeños orificios, p. ej., en las asas	X	X	X
Plástico resistente al calor hasta 200 °C	✓	✓	X
Cartón, papel	✓	X	X
Película de cocción	✓	X	X
Film para asado con cierre apto para microondas	✓	✓	X
Fuentes de metal, como esmalte o hierro fundido	X	X	✓
Moldes, barniz negro o revestimiento de silicona	X	X	✓

Material del utensilio de cocina	Función microondas		Función microondas Combi
	Descongelar	Calentar, Cocción	
Bandeja	X	X	X
Parrilla	X	X	✓
Plato inferior de cristal para microondas	✓	✓	X
Utensilios para microondas, p.ej., Crostino	X	✓	X

## Solución de problemas

Si tiene algún problema con el aparato, consulte el capítulo "Solución de problemas"

en la versión completa del manual del usuario disponible en: [www.ikea.com](http://www.ikea.com).

## Datos técnicos

Dimensiones (internas)	Ancho Alto Fondo	480 mm 217 mm 411 mm
Volúmenes útiles	43 L	
Área de la bandeja	1424 cm <sup>2</sup>	
Resistencia superior	1900 W	
Resistencia inferior	1000 W	
Grill	1900 W	
Anillo	1650 W	
Potencia total	3000 W	
Voltaje	220 - 240 V	
Frecuencia	50 Hz	
Número de funciones	17	





867371852-A-332022

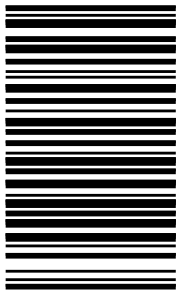

© Inter IKEA Systems B.V. 2022

21552

AA-2336027-2