

*A guide to  
buying an  
IKEA kitchen*

# IKEA KITCHENS

---

Whether you're looking for a complete kitchen system like SEKTION or one of our other kitchens, this buying guide includes the products and helpful information you need to choose the kitchen of your dreams.

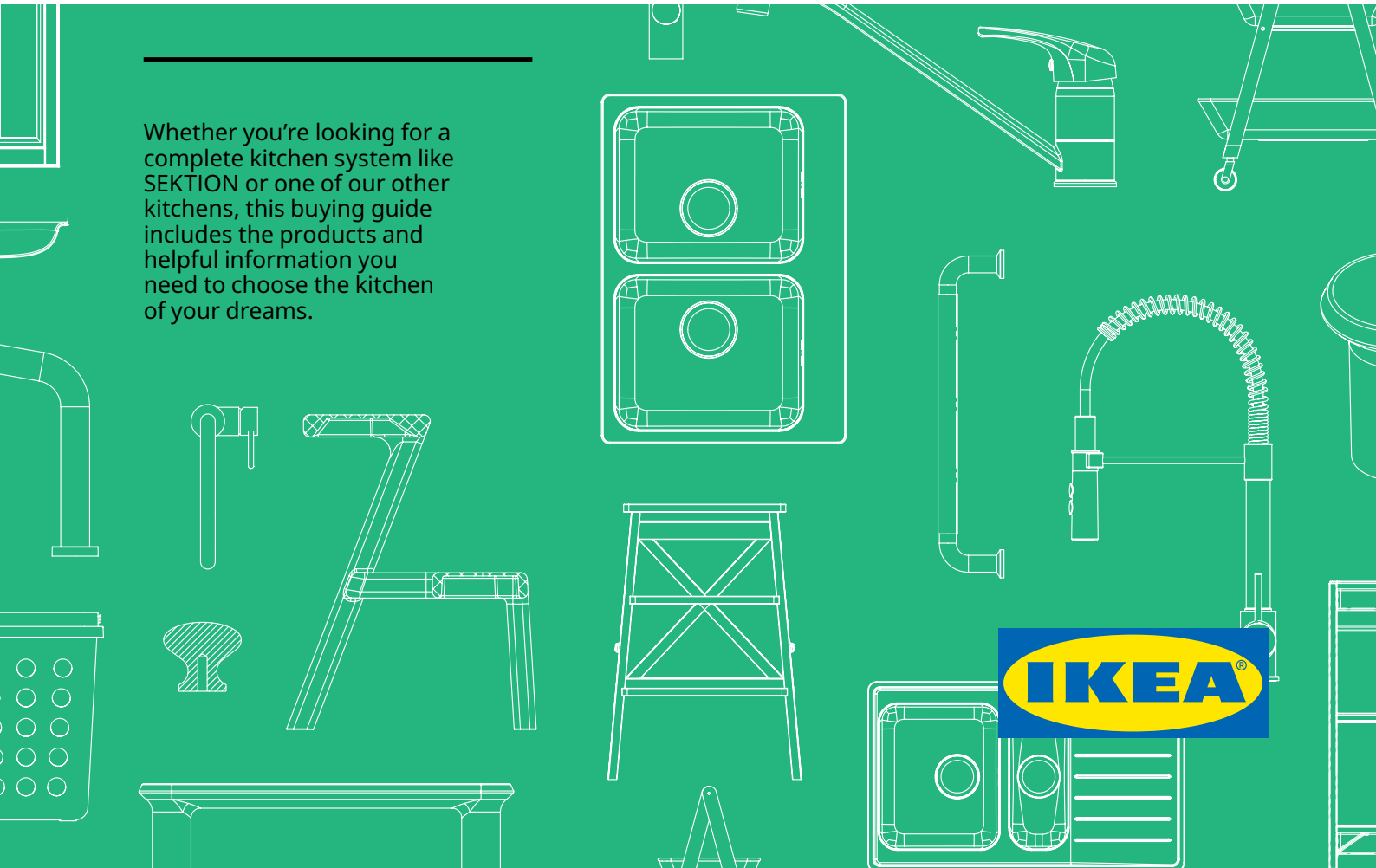



Sinks and faucets.  
See pages 80-91



Life in the kitchen goes a lot smoother when your drawers open up fully to help you reach everything. With interior fittings and organizers inside cabinets and drawers, finding what you're looking for will be easy-peasy.  
See page 44



You can do everything yourself, but you don't have to. With our broad service offer we can assist you with everything from measuring and planning to complete kitchen installation.  
See page 4



A kitchen island is a great social hub, while giving you extra counter space. The countertop of TORNVIKEN kitchen island has a durable top layer of oak and can handle everything from baking muffins to playing family games.  
See page 106

# Table of contents

<b>Services</b> .....	<b>4</b>	<b>ENHET open solutions</b> .....	<b>92</b>
<b>IKEA Kitchens</b> .....	<b>6</b>	Open cabinets and frames.....	94
<b>SEKTION kitchen system</b> .....	<b>8</b>	Accessories.....	95
Doors and drawer fronts .....	10	Lighting for ENHET.....	96
Cover panels, decorative mouldings,		<b>KNOXHULT kitchen</b> .....	<b>98</b>
Toe kicks and legs.....	22	Cabinets and fronts .....	100
Cabinets and frames.....	34	Accessories .....	103
Interior fittings and organizers .....	44	<b>SUNNERSTA mini-kitchen</b> .....	<b>104</b>
Lighting.....	52	<b>Kitchen accessories, carts and islands</b> .....	<b>106</b>
<b>Countertops</b> .....	<b>58</b>	<b>Knobs and handles</b> .....	<b>116</b>
<b>Sinks</b> .....	<b>80</b>	<b>Warranty</b> .....	<b>120</b>
<b>Kitchen faucets</b> .....	<b>86</b>	<b>Steps to buying an IKEA kitchen</b> .....	<b>124</b>



Whatever shape your kitchen takes, ENHET open frames gives you freedom to personalize your kitchen, offering plenty of storage for dishes, glasses and other special items to make it your own. All at a very affordable price.  
See page 92

# Services

## You can do it yourself, but you don't have to

Our broad service offer gives you the freedom to design your own price tag by choosing not only the products that suits your budget but also deciding how much you want to do yourself and how much you want us to do for you. On this page you'll find the different services that we can offer to help and support you. For more details about our services, talk to a co-worker at your local IKEA store or visit us at [IKEA.ca/kitchenservices](https://www.ikea.ca/kitchenservices)



### Click and Collect

Save some time by placing your order online. We'll round up everything on your shopping list and have it ready for you to collect at the time and location of your choice.



### Delivery

Whether you're shopping in store or online, no matter how big the purchase, we'll do the heavy lifting and bring it all to your home or business.



### Measuring

If you want to be sure that your room drawing is as accurate as possible, one of our Kitchen specialists will measure the room and check everything, from the placement of windows, doors, and power sockets to the material and condition of the walls.



### Kitchen consultation & planning service

Get help with ideas and the planning of your new kitchen, by choosing one of our services. Our kitchen experts will introduce the IKEA offer to you and help you with functional solutions for everything from the placement of cabinets to appliances, and storage to lighting and sinks.

#### In-store & On-line kitchen consultation

Are you thinking of a kitchen project and need more information? Our kitchen experts can help. Book your 30 min appointment today.

#### In-store assisted self planning

Drop-in to an IKEA store and we can assist you while you plan your kitchen with the help of our 3-D kitchen planning tool.

#### In-store one-on-one planning, up to 2 hours

If you prefer, you can schedule one-on-one in-store planning appointment with one of our kitchen experts.

#### Remote for On-line kitchen planning, up to 2 hours

Don't live near IKEA? Our online planning service is perfect for you and you don't even need to leave your home. We will plan over the internet.

#### In-home one-one planning, up to 3 hours

Let us come to you. Our IKEA Kitchen Service team will come to your home to take your measurements and plan your kitchen right in your home.

Visit [IKEA.ca/kitchenservices](https://www.ikea.ca/kitchenservices) for pricing and to book your appointment today!



### IKEA Kitchen Installation

As an IKEA customer, you have the right to expect that your kitchen project will be completed with the greatest skill and care.

Our IKEA kitchen service team not only have skillful hands but they also understand the inherent methods of installation required by the IKEA cabinet system. There is no question that correct installation will add years to the useful life of your kitchen.

With our help, you'll soon be cooking in the kitchen of your dreams.

See a co-worker to arrange your free installation price quote today with our IKEA kitchen service team.

Visit [IKEA.ca/kitchenservices](https://www.ikea.ca/kitchenservices) for a complete list of all our installation services.

### 5 year warranty

Installation warranty is provided by our IKEA kitchen service team and is for the installation of IKEA SEKTION kitchen products only. Non-IKEA product, ENHET and KNOXHULT kitchens are warranted for one year.

In the event of defects in workmanship and material, and the failure of the products supplied by the IKEA kitchen service team to conform with the agreement or warranty, the IKEA kitchen service team will repair or replace said product or materials; provided, that the defect or malfunction was not due to accidents, alteration by the customer, misuse, abuse or neglect.



### IKEA Home Planner

Design the SEKTION kitchen of your dreams in a 3D environment and get a price on every detail as well as the total kitchen. Print out your drawings and product list at home, or save to the IKEA website. At the IKEA store you can discuss your design and get lots of advice and guidance from our kitchen experts. Learn more at [IKEA.ca/kitchenplanner](https://www.ikea.ca/kitchenplanner)

### Want to know more?

Visit your nearest IKEA store or at [IKEA.ca/services](https://www.ikea.ca/services) for further details on pricing.



# What type of kitchen are you looking for?

Big renovations or small changes? Whether you're looking for a complete modular kitchen like SEKTION, which you can customize to your liking, or a simpler kitchen that you can set up in a day, we've got you covered. Here are three types of IKEA kitchens to meet different needs and furnish your dream kitchen.



## SEKTION kitchen system

Our SEKTION kitchen system includes cabinets in several different sizes to fit your room layout as well as your kitchen routines. The flexibility of the system offers endless choices, giving you the freedom to build a kitchen that's ideal for you and your space. We've also developed an extensive range of kitchen organizers and interior fittings allowing you to quickly see and reach even the things furthest back in the corner cabinets. In addition you have a vast choice in front expressions, countertops, lighting, sinks, faucets, knobs, handles and much more to personalize every inch of your kitchen  
See pages 8-57

**25** 25-year limited warranty



## KNOXHULT kitchen

KNOXHULT kitchen units make it easy to create a practical kitchen. The selection of units in different shapes and sizes come with pre-coordinated fronts and countertop and offer smart storage that help you stay organized, so all you have to do is combine them to suit your needs, space and preferences. When you're happy with the result, personalize with your favourite sink, faucet, appliances, knobs or handles and lighting to get a kitchen that works for you.  
See pages 98-103

**5** 5-year limited warranty



## Kitchenettes

Not everyone has the space for a larger, built-in kitchen. Whether you're after a permanent or temporary solution, our range of kitchenettes delivers all the essentials in smart, compact designs. Choose from basic or modern styles and customize your space with TILLREDA appliances to fit your needs. It's all there, personal, functional and easy to install.  
See pages 104-105, 114



# SEKTION KITCHEN SYSTEM

## Endless possibilities

The modular design of SEKTION kitchen system is easy to install and gives you endless possibilities when designing your kitchen. Whether you have a taste for the traditional, love the minimalism in modern style or land somewhere in between, you'll surely find something that fits you.

To become truly beautiful, the kitchen has to be functional and take care of all your kitchen needs, too. With SEKTION you have the freedom to get the look you

want on the outside and keep everything in perfect order on the inside. Start by deciding the style of your dream kitchen by choosing the doors and drawer fronts, lighting, countertop, sink, faucet, knobs, handles and accessories that you like.

**25**

IKEA SEKTION kitchen has a 25-year limited warranty. Find out more on [page 122](#)



# Doors and drawer fronts

---

## Choose your style!

No matter what your personal style and preference is, make sure to choose a kitchen you will love for years to come. It is the face of your kitchen, and most likely you will spend many hours in it.

We have a wide range of materials and finishes to choose from to suit your style—no matter what you like! Everything from traditional doors and drawer fronts that are rich in details, to high-gloss and modern doors and drawer fronts with integrated handles to give you that open clean look—we have it!

The process of choosing the style of your kitchen is all up to you, go for whatever you like—it is your kitchen! We have made sure that all our fronts are durable and of high quality. They all come with a 25-year limited warranty to ensure, that whatever you choose it will last for years to come.

**25**

IKEA SEKTION kitchen has a 25-year limited warranty. Find out more on **page 122**



For more product and price information please scan the QR code.



## Door and drawer front styles



### Sleek doors and drawer fronts

Sleek doors offers you straight lines and smooth, easy to clean surfaces, simplicity in its truest form. Choose from a wide variety of finishes, colours and materials.



### Frame doors and drawer fronts

Frame doors and drawer fronts are rich in detail, with a crafted look and feel—they create a kitchen with a rustic and traditional look. All our frame door families have a matching glass door.



### High-gloss doors and drawer fronts

Glossy surfaces suit everyone from the minimalist to the wild family with kids. Stains are no problem as they are just as easy to wipe clean as they were to make.



### Doors and drawer fronts with integrated handles

You might not notice them at first glance—and that's the idea! Integrated handles lend a minimalistic and modern feeling to your kitchen.

## Sleek doors and drawer fronts



### VEDDINGE

*Colour/design:* white.  
*Material:* fibreboard and painted finish.

VEDDINGE white is a smooth, sleek door that gives your kitchen a bright, modern look. Complement with HEJSTA accent door.

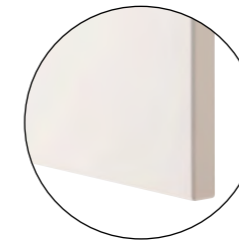

### NICKEBO

*Colour/design:* gray-green.  
*Material:* particleboard and foil finish.

NICKEBO is a door with sleek, straight lines and brings a colourful, modern look to your kitchen. Complement with HEJSTA accent door.

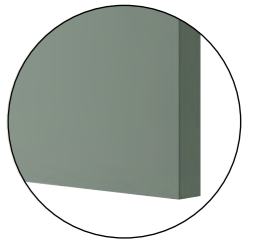

### ASKERSUND

*Colour/design:* light ash wood effect.  
*Material:* particleboard and melamine foil finish.

ASKERSUND is a blonde ash wood effect door, with a grain pattern that you can see and feel. It creates a light, modern kitchen. Complement with HEJSTA accent door.



### VALLSTENA

*Colour/design:* white.  
*Material:* particleboard and foil finish.

VALLSTENA kitchen fronts have a smooth clean surface that is easy to coordinate in your kitchen. A timeless expression that always feels fresh. Complement with HEJSTA accent door.

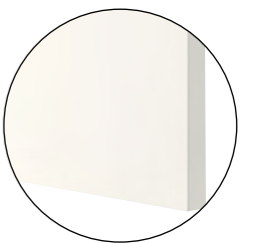

## Sleek doors and drawer fronts

**SINARP**

*Colour/design:* oak.  
*Material:* particleboard, oak veneer, tinted and clear lacquer.

SINARP fronts offer a timeless design with a modern twist, in natural oak veneer with wooden tones full of character. Solid oak edging outlines the front, adding an elegant detail to your kitchen.  
Complement with HEJSTA accent door.

**SINARP**

*Colour/design:* brown stain, oak veneer.  
*Material:* particleboard, oak veneer, solid oak edge.

SINARP is a door with sleek, straight lines and brings a rich, modern look to your kitchen.  
Complement with HEJSTA accent door.

**NICKEBO**

*Colour/design:* anthracite.  
*Material:* particleboard and recycled plastic.

NICKEBO fronts with a matte black surface creates a stylish and modern look to your kitchen. A simple design that you can make your own. Made from recycled wood with a foil finish from mainly recycled plastic.  
Complement with HEJSTA accent door.

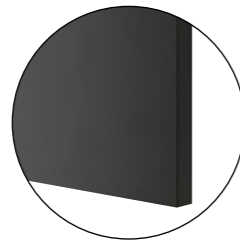
**TISTORP**

*Colour/design:* walnut wood effect.  
*Material:* fibreboard and foil finish.

TISTORP is a classic door with smooth surface and simple design. The wooden finish makes a warm impression with modern style.  
Complement with HEJSTA accent door.



## Sleek doors and drawer fronts

**HAVSTORP**

*Colour/design:* light gray.  
*Material:* fiberboard and painted finish.

HAVSTORP fronts in timeless light gray are defined by clean straight lines and smooth surface that create a neutral and harmonious expression that is easy to personalize.  
Complement with HEJSTA accent door.

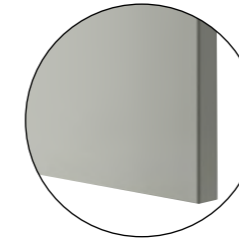
**HAVSTORP**

*Colour/design:* deep green  
*Material:* fiberboard and painted finish.

HAVSTORP deep green is defined by clean straight lines and a smooth surface. The expression is a confident choice for a unique style.  
Complement with HEJSTA accent door.

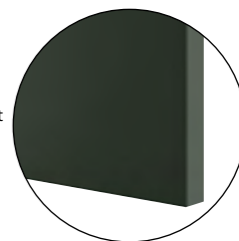

## Framed doors and drawer fronts

**ASPUDDEN New**

*Colour/design:* dark gray-green.  
*Material:* particleboard and foil finish.

The elegant thin frame on ASPUDDEN fronts enhances the minimalist appeal, offering a timeless look with a subtle statement. The dark gray-green finish creates a warm and welcoming kitchen expression.  
Complement with HEJSTA accent door.

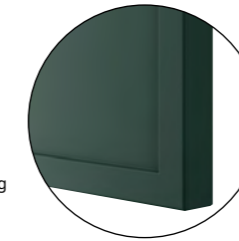
**ASPUDDEN New**

*Colour/design:* light gray.  
*Material:* particleboard and foil finish.

The elegant thin frame on ASPUDDEN fronts enhances the minimalist appeal, offering a timeless look with a subtle statement. The light gray finish brings a calm and inviting feel to your kitchen.  
Complement with HEJSTA accent door.



## Framed doors and drawer fronts

**AXSTAD**

*Colour/design:* matte white.  
*Material:* fibreboard and foil finish.

AXSTAD door has a matte, white surface with soft lines and a recessed center panel. The design allows you to use it to create both a modern and traditional kitchen. Complement with AXSTAD tempered glass doors.

**AXSTAD**

*Colour/design:* gray green.  
*Material:* fibreboard and foil finish.

AXSTAD door has a matte, gray green surface with soft lines and a recessed center panel. The design allows you to use it to create both a modern and traditional kitchen. Complement with AXSTAD tempered glass doors.

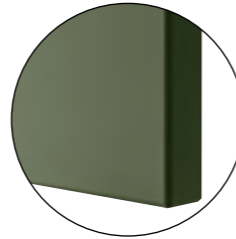

## Framed doors and drawer fronts

**ENKÖPING**

*Colour/design:* walnut wood effect.  
*Material:* fibreboard and foil finish.

ENKÖPING door with frame and recessed center panel has a subtle grain structure that gives you an authentic wood character. Complement with ENKÖPING tempered glass doors.

**ENKÖPING**

*Colour/design:* white wood effect.  
*Material:* fibreboard and foil finish.

ENKÖPING door with frame and recessed center panel has a subtle grain structure that gives you an authentic wood character. Complement with ENKÖPING tempered glass doors.

**LERHYTTAN**

*Colour/design:* black stained.  
*Material:* stained ash veneer and solid ash.

LERHYTTAN door has a distinct traditional character, with a solid wood frame, bevelled edges and a recessed veneer centre panel. LERHYTTAN creates a cozy kitchen with rustic charm. Complement with LERHYTTAN tempered glass doors.

**LERHYTTAN New**

*Colour/design:* blue.  
*Material:* stained birch veneer and solid birch.

LERHYTTAN door has a distinct traditional character, with a solid wood frame, bevelled edges and a recessed veneer centre panel. LERHYTTAN creates a cozy kitchen with rustic charm. Complement with LERHYTTAN tempered glass doors.

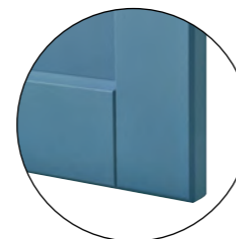
**BODBYN**

*Colour/design:* off-white.  
*Material:* fibreboard and painted finish.

Rich in detail, BODBYN off-white door has a panel that is bevelled on the inside and contoured on the outside. It gives your kitchen a traditional touch. Complement with BODBYN tempered glass doors.

**VEDHAMN**

*Colour/design:* natural oak.  
*Material:* clear lacquered oak veneer and solid oak.

Each VEDHAMN door is unique, with varying grain patterns and shifts in colour that highlight the natural charm of wood. It brings the feeling of tradition, quality and handmade craftsmanship to your kitchen. Complement with VEDHAMN tempered glass doors.



### High-gloss doors and drawer fronts



**RINGHULT**

*Colour/design:* high-gloss white.  
*Material:* particleboard and high-gloss foil finish.

RINGHULT white doors have sleek, straight lines and a high-gloss surface that's durable and easy to clean. RINGHULT brings a bright, modern look to your kitchen. Complement with HEJSTA accent door.



**VOXTORP**

*Colour/design:* high gloss dark gray brown.  
*Material:* Particleboard and high-gloss foil finish.

VOXTORP is a high-gloss front with a surface that's durable and easy to clean. With the integrated handle, this front brings clean lines and a modern design to your kitchen. Complement with HEJSTA accent door.

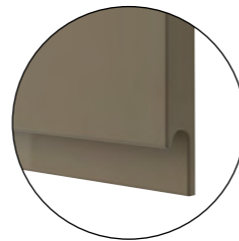

### Fronts with integrated handles



**VOXTORP**

*Colour/design:* matte white.  
*Material:* particleboard and foil finish.

VOXTORP is a smooth, matte door with integrated handles. It brings clean lines and an open, modern look to your kitchen. Complement with HEJSTA accent door.

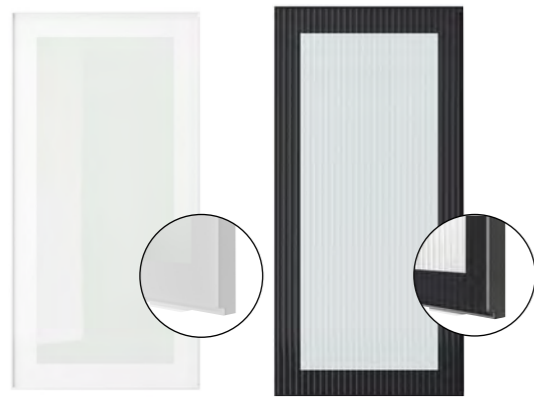

## Accent doors

**HEJSTA**

*Colour/design:* white/clear glass and aluminum.  
Black/reeded glass and aluminum.  
*Material:* tempered glass and aluminum.

HEJSTA white or black reeded glass doors are versatile and blend perfectly with all our other kitchen fronts. A perfect option if you've chosen a family of fronts with no glass doors. Handles included.

White/clear glass, W15xH30"	805.266.21
Black/reeded glass, W15xH30"	605.266.22

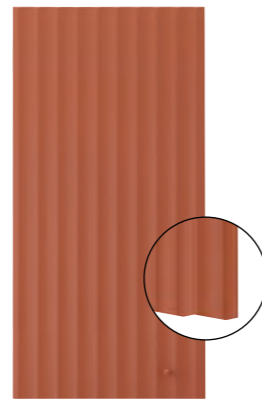
**TERRSJÖ** *New*

*Colour/design:* red-brown wave pattern.  
*Material:* fiberboard, foil finish.

The fronts bring a sense of movement to your kitchen with a playful and eye-catching wavy structure. A warm terracotta glow sets the tone, complemented by the matching knob included.

W15xH30"	406.053.85
W15xH40"	006.053.87
W18xH30"	606.053.89
W18xH40"	406.053.90
W24xH30"	206.053.91
W24xH40"	006.053.92



## Accent drawer fronts

**STENSTA** drawer front

*Colour/design:* dark brown ash.  
*Material:* ash veneer in brown stain and clear acrylic lacquer.

The solid wood handle has a softly rounded grip and stretches across the full width of the front to enhance the beautiful linear expression.

W18xH10"	105.609.63
W18xH15"	905.609.64
W24xH10"	605.609.65
W24xH15"	405.609.66
W30xH10"	205.609.67
W30xH15"	005.609.68
W36xH10"	005.928.27
W36xH15"	805.928.28

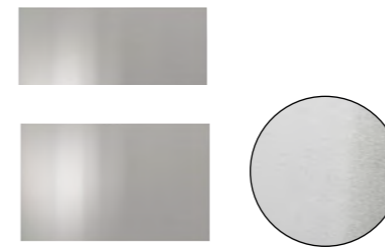

## Accent drawer fronts

**NOGSTA** drawer front

*Colour/design:* stainless steel.  
*Material:* particleboard, melamine foil and stainless steel.

W18xH10"	505.315.96
W18xH15"	305.315.97
W24xH10"	105.315.98
W24xH15"	905.315.99
W30xH10"	505.316.00
W30xH15"	305.316.01

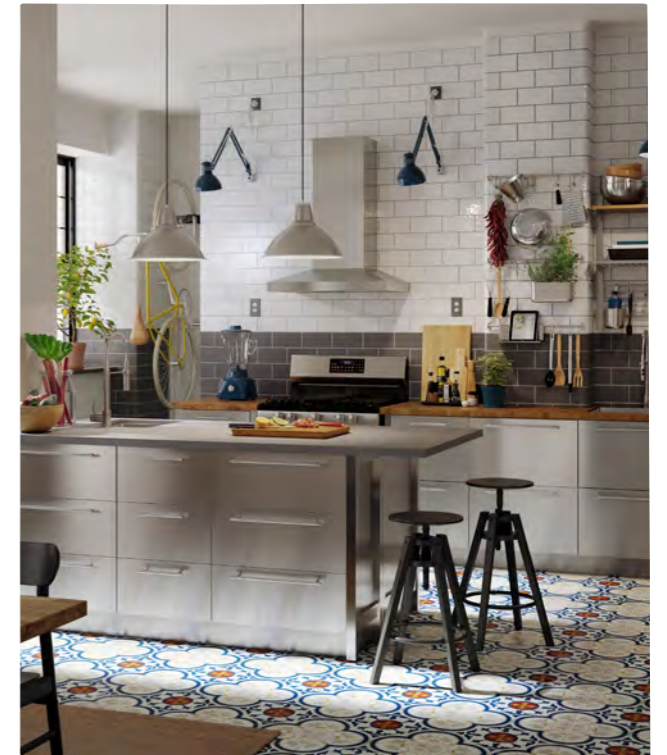
**FRÖJERED** drawer front

*Colour/design:* light bamboo.  
*Material:* clear lacquered bamboo.

W18xH10"	004.416.35
W18xH15"	804.416.36
W24xH10"	604.416.37
W24xH15"	404.416.38
W30xH10"	204.416.39
W30xH15"	804.416.41

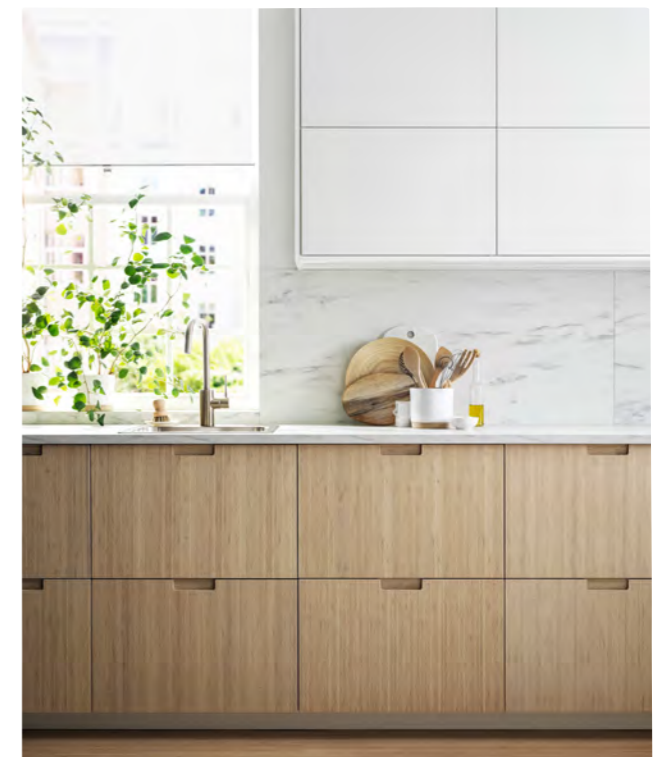

# Cover panels, decorative mouldings, toe kicks and legs

---

## Add the finishing touches

Whether you've decided to go for a more traditional style with lots of drawers and decorative elements, or a sleek modern, more minimalistic style, there are still finishing touches for you to add to make your kitchen stunning.

Enhance your style with uniform cover panels, decorative mouldings, legs and toe kicks. Or, you can be a bit bold and go for a finish that contrasts with your doors and drawers. It's all up to you.



## Cover panels

Choose a cover panel in the same finish as your door for a uniform expression, or mix and match to suit your taste.

**ASKERSUND cover panel**, light ash wood effect.



Available sizes, width×height	
W15×H32½"	403.483.48
W15×H42½"	203.483.49
W15×H90"	003.483.50
W25×H30"	803.483.51
W25×H80"	603.483.52
W25×H90"	403.483.53
W26×H36"	203.483.54
W36×H96"	803.483.94

**LERHYTTAN cover panel**, stained black.

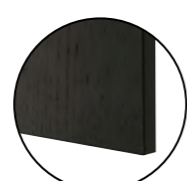

Available sizes, width×height	
W15×H31¼"	803.559.21
W15×H41¼"	603.559.22
W15×H90"	403.559.23
W25×H30"	203.559.24
W25×H80"	903.559.25
W25×H90"	703.559.26
W26×H36"	503.559.27
W36×H96"	303.559.28

**VOXTORP cover panel**, high-gloss dark gray-brown.

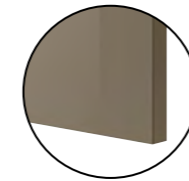

Available sizes, width×height	
W15×H32½"	606.017.20
W15×H42½"	406.017.21
W15×H90"	206.017.22
W25×H30"	006.017.23
W25×H80"	806.017.24
W25×H90"	506.017.25
W26×H36"	306.017.26
W36×H96"	106.017.27

**ASPUDDEN cover panel**, light gray. **New**

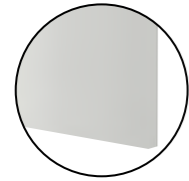

Available sizes, width×height	
W15×H30½"	205.963.15
W15×H40½"	005.963.16
W15×H90"	805.963.17
W25×H30"	605.963.18
W25×H80"	405.963.19
W25×H90"	205.963.20
W26×H36"	005.963.21
W36×H96"	805.963.22
For lighting, width×height	
W10⅝×H87"	405.950.32
Deco panel, width×height	
W15×H30"	405.963.62
W25×30"	205.963.63

**LERHYTTAN cover panel**, stained blue. **New**

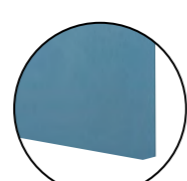

Available sizes, width×height	
W15×H31¼"	206.014.87
W15×H41¼"	006.014.88
W15×H90"	806.014.89
W25×H30"	606.014.90
W25×H80"	406.014.91
W25×H90"	206.014.92
W26×H36"	006.014.93
W36×H96"	806.014.94

**NOGSTA cover panel**, stainless steel.

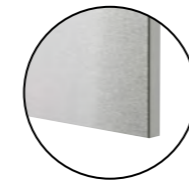

Available sizes, width×height	
W15×H30"	405.315.92
W25×H30"	205.315.93

**ASPUDDEN cover panel**, dark gray-green. **New**

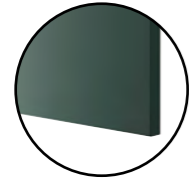

Available sizes, width×height	
W15×H30½"	106.033.78
W15×H40½"	906.033.79
W15×H90"	706.033.80
W25×H30"	506.033.81
W25×H80"	306.033.82
W25×H90"	106.033.83
W26×H36"	906.033.84
W36×H96"	606.033.85
For lighting, width×height	
W10⅝×H87"	205.953.54
Deco panel, width×height	
W15×H30"	206.033.87
W25×30"	406.033.86

**VALLSTENA cover panel**, white foil.



Available sizes, width×height	
W15×H30"	505.965.78
W15×H40"	305.965.79
W15×H90"	105.965.80
W25×H30"	905.965.81
W25×H80"	705.965.82
W25×H90"	505.965.83
W26×H36"	305.965.84

**NOGSTA cover panel with leg**, stainless steel.

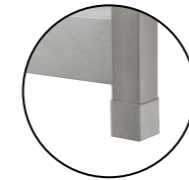

Available sizes, width×height	
W15×H35"	005.315.94
W24×H35"	705.315.95

**FRÖJERED cover panel**, bamboo.



Available sizes, width×height	
W15⅝×H30"	604.416.23
W25×H30"	404.416.24

**AXSTAD cover panel**, matte gray-green.

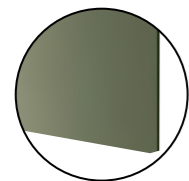

Available sizes, width×height	
W15×H32½"	505.639.12
W15×H42½"	305.639.13
W15×H90"	105.639.14
W25×H30"	805.639.15
W25×H80"	605.639.16
W25×H90"	405.639.17
W26×H36"	205.639.18
W36×H96"	005.639.19

**HAVSTORP cover panel**, deep green.

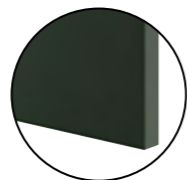

Available sizes, width×height	
W15×H32½"	305.763.88
W15×H42½"	105.763.89
W15×H90"	905.763.90
W25×H30"	705.763.91
W25×H80"	505.763.92
W25×H90"	305.763.93
W26×H36"	105.763.94
W36×H96"	805.763.95

**SINARP cover panel**, brown.



Available sizes, width×height	
W15×H32½"	604.046.73
W15×H42½"	404.046.74
W15×H90"	104.046.75
W25×H30"	904.046.76
W25×H80"	704.046.77
W25×H90"	504.046.78
W26×H36"	304.046.79
W36×H96"	104.046.80

**NICKEBO cover panel**, gray-green.

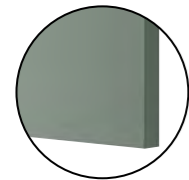

Available sizes, width×height	
W15×H31⅝"	505.625.64
W15×H41⅝"	205.625.65
W15×H90"	005.625.66
W25×H30"	805.625.67
W25×H80"	605.625.68
W25×H90"	405.625.69
W26×H36"	205.625.70
W36×H96"	005.625.71

**HAVSTORP cover panel**, light gray.

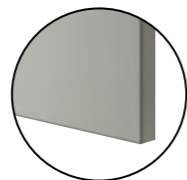

Available sizes, width×height	
W15×H32½"	605.877.81
W15×H42½"	405.877.82
W15×H90"	205.877.83
W25×H30"	005.877.84
W25×H80"	705.877.85
W25×H90"	505.877.86
W26×H36"	305.877.87
W36×H96"	105.877.88

**SINARP cover panel**, oak. **New**



Available sizes, width×height	
W15×H32½"	906.034.40
W15×H42½"	706.034.41
W15×H90"	506.034.42
W25×H30"	306.034.43
W25×H80"	106.034.44
W25×H90"	806.034.45
W26×H36"	606.034.46
W36×H96"	406.034.47



**TERRSJÖ cover panel**, red-brown. **New**

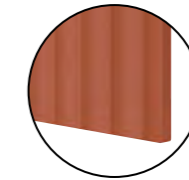

Wave pattern	
Available sizes, width×height	
W15×H30½"	506.057.14
W15×H40½"	206.057.15
W25×H30"	406.232.09
Cover panel, width×height	
W15×H90"	006.057.16
For lighting, width×height	
W10⅝×H87"	206.057.39

**STENSTA cover panel**, dark brown ash veneer.

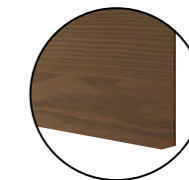

Available sizes, width×height	
W15⅝×H30"	505.609.61
W25×H30"	305.609.62

**VEDHAMN cover panel**, natural oak.



Available sizes, width×height	
W15×H31⅝"	805.051.38
W15×H41⅝"	605.051.39
W15×H90"	405.051.40
W25×H30"	205.051.41
W25×H80"	005.051.42
W25×H90"	605.051.44
W26×H36"	305.051.45
W36×H96"	105.051.46

## FÖRBÄTTRA cover panels

Our FÖRBÄTTRA cover panels are developed to fit all our various white doors and drawer fronts. Choose a FÖRBÄTTRA in the same colour and finish as your door for a perfect match.

### FÖRBÄTTRA cover panel, off-white.



Available sizes, width×height	
W15×H32½"	602.664.07
W15×H42½"	402.664.08
W15×H90"	202.664.09
W25×H30"	802.664.11
W25×H80"	402.664.13
W25×H90"	202.664.14
W26×H36"	602.664.12
W36×H96"	902.664.15

### FÖRBÄTTRA cover panel, matte white.



Available sizes, width×height	
W15×H32½"	105.678.32
W15×H42½"	905.678.33
W15×H90"	705.678.34
W25×H30"	405.678.35
W25×H80"	205.678.36
W25×H90"	005.678.37
W26×H36"	304.177.52
W36×H96"	104.177.53

### FÖRBÄTTRA cover panel, white.



Available sizes, width×height	
W15×H32½"	302.664.37
W15×H42½"	102.664.38
W15×H90"	902.664.39
W25×H30"	702.664.40
W25×H80"	302.664.42
W25×H90"	102.664.43
W26×H36"	502.664.41
W36×H96"	902.664.44

### FÖRBÄTTRA cover panel, matte anthracite.

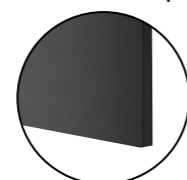

Available sizes, width×height	
W15×H31½"	204.706.84
W15×H41½"	904.706.85
W15×H90"	704.706.86
W25×H30"	504.706.87
W25×H80"	304.706.88
W25×H90"	104.706.89
W26×H36"	904.706.90
W36×H96"	704.706.91

### FÖRBÄTTRA cover panel, high-gloss white.



Available sizes, width×height	
W15×H32½"	805.687.10
W15×H42½"	605.687.11
W15×H90"	405.687.12
W25×H30"	205.687.13
W25×H80"	005.687.14
W25×H90"	705.687.15
W26×H36"	704.002.93
W36×H96"	504.002.94

### FÖRBÄTTRA cover panel, brown walnut effect.



Available sizes, width×height	
W15×H31½"	605.585.14
W15×H41½"	305.585.15
W15×H90"	105.585.16
W25×H30"	905.585.17
W25×H80"	705.585.18
W25×H90"	505.585.19
W26×H36"	305.585.20
W36×H96"	105.585.21

## Decorative mouldings

Decorative mouldings provides the finishing touch to your kitchen. They come in many different styles, but we have something for all or our door and drawer families. Use them to tie your style together, hide lighting or just as a decorative element.

You can choose how to mount them on your cabinets. Below we show the entire range and some different ways of mounting them both above as mouldings and below your cabinet, either wrapped around the whole cabinet or just between your cover panels.

### ASKERSUND decorative moulding rounded, light ash wood effect.

87×2¾" 803.318.50



### ENKÖPING decorative moulding contoured, white wood effect.

87×2¾" 805.057.51



### AXSTAD decorative moulding rounded, matte gray-green.

87×2¾" 505.639.26



### BODBYN decorative moulding contoured, off-white.

87×2¾" 804.177.59



### VEDHAMN decorative moulding contoured, natural oak.

87×1½" 205.003.70



N/A

## Decorative mouldings

**NICKEBO decorative moulding rounded,**  
gray-green.

87×2¾" 905.625.62

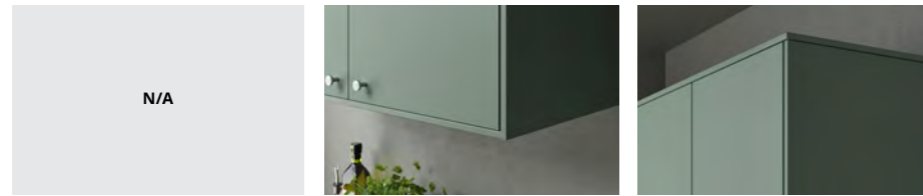

**HAVSTORP decorative moulding rounded,**  
deep green.

87×2¾" 405.683.64



**HAVSTORP decorative moulding rounded,**  
light gray.

87×2¾" 905.684.70

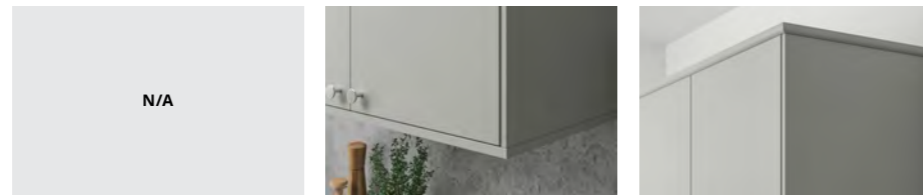

**VOXTORP decorative moulding rounded,**  
high-gloss dark gray-brown.

87×2¾" 505.817.51



**LERHYTTAN decorative moulding contoured,**  
stained black.

87×1¾" 903.560.91



**New**

**LERHYTTAN decorative moulding contoured,**  
stained blue.

87×2¾" 205.949.86



**SINARP decorative moulding rounded,**  
brown oak veneer.

87×2¾" 104.041.47

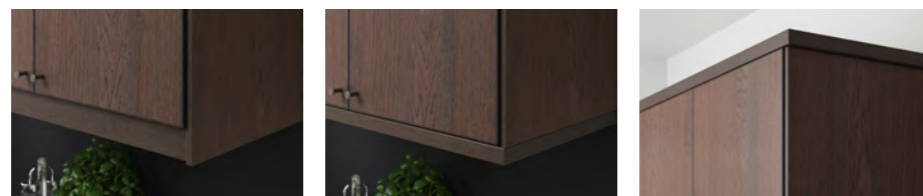

**SINARP decorative moulding rounded,**  
oak veneer.

87×2¾" 005.951.66



## FÖRBÄTTRA decorative mouldings

Our FÖRBÄTTRA decorative mouldings are developed to fit all our various white doors and drawer fronts. Choose a FÖRBÄTTRA in the same colour and finish as your door for a perfect match.

**FÖRBÄTTRA decorative moulding rounded,**  
off-white.

87×2¾" 702.069.60



**FÖRBÄTTRA decorative moulding rounded,**  
white.

87×2¾" 202.978.87



**FÖRBÄTTRA decorative moulding rounded,**  
high-gloss white.

87×2¾" 503.974.80



**FÖRBÄTTRA decorative moulding rounded,**  
matte white.

87×2¾" 704.176.65



**FÖRBÄTTRA decorative moulding rounded,**  
matte anthracite.

87×2¾" 005.267.43



**FÖRBÄTTRA decorative moulding contoured,**  
brown walnut effect.

87×2¾" 005.584.80



## Toe kicks and legs

Choose between a regular or a decorative toe kick to cover the gap between your cabinet and the floor. As an alternative to a toe kick you can also choose to put legs on your base and high cabinets.

### New

**LERHYTTAN**, blue and blue stained birch.



Standard toe kick 84×4½"

206.015.38



Leg for decorative toe kick, 2-pack

406.015.37



Corner leg for decorative toe kick, 2-pack

406.014.86

**LERHYTTAN**, black and black stained ash.



Standard toe kick 84×4½"

303.559.71



Leg for decorative toe kick, 2-pack

703.978.13



Corner leg for decorative toe kick, 2-pack

804.032.29

**VEDHAMN**, natural oak and oak effect.



Standard toe kick 84×4½"

305.051.88



Decorative leg, 2-pack

105.054.10

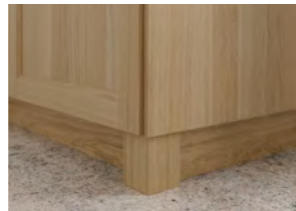

Decorative corner leg, 2-pack

305.054.09

### Standard toe kicks

**ASKERSUND** light ash wood effect.

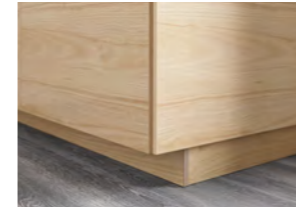

Toe kick 84×4½"

406.259.77

**ASPUDDEN** dark gray-green.



Toe kick 84×4½"

**New** 806.034.26

**AXSTAD** matte gray-green.



Toe kick 84×4½"

505.640.06

**NICKEBO** gray-green.



Toe kick 84×4½"

805.625.72

**HAVSTORP** deep green.



Toe kick 84×4½"

505.764.34

**HAVSTORP** light gray.



Toe kick 84×4½"

505.878.28

**ASPUDDEN** light gray.



Toe kick 84×4½"

**New** 605.963.61

**VOXTORP** high-gloss dark gray-brown.



Toe kick 84×4½"

706.017.29

**SINARP** oak effect.



Toe kick 84×4½"

**New** 206.111.89

**SINARP** brown wood effect.

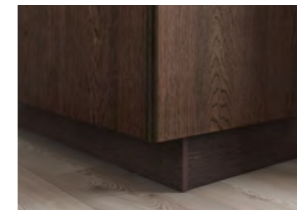

Toe kick 84×4½"

704.047.24

**STENSTA** dark brown ash effect.



Toe kick 84×4½"

305.921.28

**NOGSTA** stainless steel colour.



Toe kick 84×4½"

105.316.02

## FÖRBÄTTRA toe kicks and legs

Our FÖRBÄTTRA toe kicks and legs are developed to fit all our various white doors and drawer fronts. Choose a FÖRBÄTTRA in the same white colour and finish as your door for a perfect match.

### FÖRBÄTTRA off-white.



Standard toe kick 84×4½"

402.875.90



Decorative toe kick 87×4½"

002.786.77



Leg 4½", 2-pack

402.786.75

### FÖRBÄTTRA white.



Standard toe kick 84×4½"

602.668.17



Standard toe kick 84×4½"

204.002.95



Standard toe kick 84×4½"

904.177.54

### FÖRBÄTTRA matte anthracite.



Standard toe kick 84×4½"

204.707.35

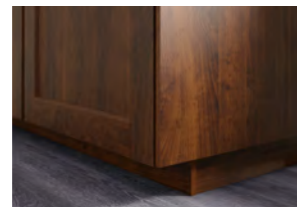

Toe kick 84×4½"

105.585.59

## Legs



**SEKTION leg**, 3½-5½", 2-pack.  
May be completed with toe kick.

Black 905.560.71



**CAPITA leg**, H4-5", 4-pack.

Stainless steel 602.635.74



# SEKTION cabinets

---

## Modular cabinets that fits your space

What does your dream kitchen look like? How much time will you spend in it and how will you use it? When it comes to kitchens, we're all different. We have different dreams, different needs and different preconditions. To meet this diversity, what could be better than a highly flexible kitchen system with cabinets that can suit everyone, and be planned in everywhere? Whatever the size of your home or family, with cabinets in different sizes, drawers with endless possibilities and interior organizers made to match, you can turn the kitchen of your dreams into the kitchen in your home.

**25**

IKEA SEKTION kitchen has a 25-year limited warranty. Find out more in the [warranty brochure](#).



On this page you can see all available SEKTION cabinets and their sizes.  
Choose and mix them to fit the architecture of you room as well as your own needs.

### SEKTION base cabinets

	<b>SEKTION base cabinet frame, W12xD14¼xH30".</b> White <span style="float: right;">902.653.92</span>
	<b>SEKTION base cabinet frame, W12xD24xH30".</b> White <span style="float: right;">102.653.92</span>
	<b>SEKTION base cabinet frame, W15xD14¼xH30".</b> White <span style="float: right;">302.653.91</span>
	<b>SEKTION base cabinet frame, W15xD24xH30".</b> White <span style="float: right;">002.653.97</span>
	<b>SEKTION base cabinet frame, W18xD14¼xH30".</b> White <span style="float: right;">702.653.94</span>
	<b>SEKTION base cabinet frame, W18xD24xH30".</b> White <span style="float: right;">202.653.96</span>
	<b>SEKTION base cabinet frame, W24xD14¼xH30".</b> White <span style="float: right;">402.653.95</span>
	<b>SEKTION base cabinet frame, W24xD24xH30".</b> White <span style="float: right;">902.653.88</span>
	<b>SEKTION base cabinet frame, W30xD14¼xH30".</b> White <span style="float: right;">502.653.90</span>
	<b>SEKTION base cabinet frame, W30xD24xH30".</b> White <span style="float: right;">302.653.86</span>
	<b>SEKTION base cabinet frame, W36xD14¼xH30".</b> White <span style="float: right;">702.653.89</span>
	<b>SEKTION base cabinet frame, W36xD24xH30".</b> White <span style="float: right;">802.653.98</span>





### SEKTION base cabinet for built-in oven

	<b>SEKTION base cabinet for oven, W30xD24xH30".</b> White <span style="float: right;">502.986.49</span>
--	--

### SEKTION top cabinets



	<b>SEKTION fridge/freezer top cabinet frame, W24xD24xH15".</b> White <span style="float: right;">904.997.35</span>
	<b>SEKTION fridge/freezer top cabinet frame, W30xD24xH15".</b> White <span style="float: right;">602.655.11</span>
	<b>SEKTION fridge/freezer top cabinet frame, W30xD24xH20".</b> White <span style="float: right;">402.655.12</span>
	<b>SEKTION fridge/freezer top cabinet frame, W36xD24xH10".</b> White <span style="float: right;">404.783.92</span>
	<b>SEKTION fridge/freezer top cabinet frame, W36xD24xH15".</b> White <span style="float: right;">002.655.09</span>
	<b>SEKTION fridge/freezer top cabinet frame, W36xD24xH20".</b> White <span style="float: right;">202.655.13</span>

### SEKTION wall cabinets



	<b>SEKTION wall cabinet frame, W12xD14¼xH30".</b> White <span style="float: right;">102.654.72</span>
	<b>SEKTION wall cabinet frame, W12xD14¼xH40".</b> White <span style="float: right;">902.654.73</span>
	<b>SEKTION wall cabinet frame, W15xD14¼xH15".</b> White <span style="float: right;">102.654.67</span>
	<b>SEKTION wall cabinet frame, W15xD14¼xH20".</b> White <span style="float: right;">802.654.59</span>
	<b>SEKTION wall cabinet frame, W15xD14¼xH30".</b> White <span style="float: right;">902.654.54</span>
	<b>SEKTION wall cabinet frame, W15xD14¼xH40".</b> White <span style="float: right;">002.654.63</span>

### SEKTION wall cabinets





	<b>SEKTION wall cabinet frame, W18xD14¼xH15".</b> White <span style="float: right;">602.654.55</span>
	<b>SEKTION wall cabinet frame, W18xD14¼xH20".</b> White <span style="float: right;">502.654.65</span>
	<b>SEKTION wall cabinet frame, W18xD14¼xH30".</b> White <span style="float: right;">802.654.64</span>
	<b>SEKTION wall cabinet frame, W18xD14¼xH40".</b> White <span style="float: right;">002.654.58</span>
	<b>SEKTION wall cabinet frame, W24xD14¼xH15".</b> White <span style="float: right;">302.654.66</span>
	<b>SEKTION wall cabinet frame, W24xD14¼xH20".</b> White <span style="float: right;">202.654.57</span>
	<b>SEKTION wall cabinet frame, W24xD14¼xH30".</b> White <span style="float: right;">702.654.50</span>
	<b>SEKTION wall cabinet frame, W24xD14¼xH40".</b> White <span style="float: right;">502.654.70</span>
	<b>SEKTION wall cabinet frame, W30xD14¼xH15".</b> White <span style="float: right;">202.654.62</span>
	<b>SEKTION wall cabinet frame, W30xD14¼xH20".</b> White <span style="float: right;">102.654.53</span>
	<b>SEKTION wall cabinet frame, W30xD14¼xH30".</b> White <span style="float: right;">702.654.69</span>
	<b>SEKTION wall cabinet frame, W30xD14¼xH40".</b> White <span style="float: right;">902.654.68</span>
	<b>SEKTION wall cabinet frame, W36xD14¼xH15".</b> White <span style="float: right;">402.654.56</span>

	<b>SEKTION wall cabinet frame, W36xD14¼xH20".</b> White <span style="float: right;">302.654.71</span>
	<b>SEKTION wall cabinet frame, W36xD14¼xH30".</b> White <span style="float: right;">902.654.49</span>
	<b>SEKTION wall cabinet frame, W36xD14¼xH40".</b> White <span style="float: right;">602.654.60</span>

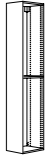

### SEKTION wall cabinet for built-in extractor hood

	<b>SEKTION wall cabinet for extractor hood with shelf, W30xD14¼xH20".</b> White <span style="float: right;">304.873.49</span>
	<b>SEKTION wall cabinet for extractor hood with shelf, W30xD14¼xH30".</b> White <span style="float: right;">904.873.51</span>

## SEKTION high cabinets

	<b>SEKTION high cabinet frame, W15xD14 3/4 x H80".</b> White <u>202.654.43</u>
	<b>SEKTION high cabinet frame, W15xD14 3/4 x H90".</b> White <u>602.654.41</u>
	<b>SEKTION high cabinet frame, W15xD24 x H80".</b> White <u>802.654.40</u>
	<b>SEKTION high cabinet frame, W15xD24 x H90".</b> White <u>102.654.48</u>
	<b>SEKTION high cabinet frame, W18xD14 3/4 x H80".</b> White <u>402.654.42</u>
	<b>SEKTION high cabinet frame, W18xD14 3/4 x H90".</b> White <u>602.654.36</u>
	<b>SEKTION high cabinet frame, W18xD24 x H80".</b> White <u>002.654.44</u>
	<b>SEKTION high cabinet frame, W18xD24 x H90".</b> White <u>002.654.39</u>
	<b>SEKTION high cabinet frame, W24xD14 3/4 x H80".</b> White <u>402.654.37</u>
	<b>SEKTION high cabinet frame, W24xD14 3/4 x H90".</b> White <u>302.654.47</u>
	<b>SEKTION high cabinet frame, W24xD24 x H80".</b> White <u>202.654.38</u>
	<b>SEKTION high cabinet frame, W24xD24 x H90".</b> White <u>702.654.45</u>
	<b>SEKTION high cabinet frame, W30xD24 x H80".</b> White <u>204.874.15</u>
	<b>SEKTION high cabinet frame, W30xD24 x H90".</b> White <u>404.874.19</u>

## SEKTION high cabinet for built-in refrigerator

	<b>SEKTION high cabinet for built-in refrigerator, W24xD24 x H80".</b> White <u>804.997.31</u>
	<b>SEKTION high cabinet for built-in refrigerator, W24xD24 x H90".</b> White <u>004.997.30</u>







## SEKTION corner cabinets

	<b>SEKTION corner base cabinet frame, W38xD38 x H30".</b> White <u>705.967.56</u>
	<b>SEKTION corner base cabinet frame, W50xD26 x H30".</b> White <u>505.967.57</u>
	<b>SEKTION corner wall cabinet frame, W26xD26 x H20".</b> White <u>802.655.05</u>
	<b>SEKTION corner wall cabinet frame, W26xD26 x H30".</b> White <u>102.655.04</u>
	<b>SEKTION corner wall cabinet frame, W26xD26 x H40".</b> White <u>302.655.03</u>

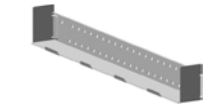
## SEKTION top rail







	<b>SEKTION reinforced ventilated top rail, galvanized.</b> Use for sink and cook top base cabinet solutions.
L24"	<u>002.845.79</u>
L30"	<u>802.845.80</u>
L36"	<u>602.845.81</u>

## NYTTIG for appliance installation

	<b>NYTTIG filler piece for wall oven/microwave,</b> used as filler between the oven and the microwave. <u>105.911.15</u>		<b>NYTTIG back filler for microwave hood,</b> to be installed between the wall and the back of the microwave hood. 24" <u>705.236.61</u> 30" <u>105.365.05</u>
	<b>NYTTIG support bracket for microwave trim kit.</b> <u>505.910.24</u>		<b>NYTTIG cooktop/drawer separator,</b> used for cooktop and drawer combination. 30" <u>602.906.76</u> 36" <u>802.906.75</u>
	<b>NYTTIG filler piece for microwave hood/cabinet,</b> to be installed between the microwave hood and the bottom of the cabinet. 24" <u>905.236.60</u> 30" <u>005.312.35</u>		<b>NYTTIG vent plinth,</b> mandatory for installation with RENGJORD fully integrated dishwasher. 24" <u>204.997.29</u>
			<b>NYTTIG filler piece for built-in oven in base cabinet.</b> 30" <u>905.940.54</u>

## Open storage

Create a nice break in a row of cabinets with doors using open cabinets. Your kitchen becomes more personal and you can have often used items like cookbooks within arm's reach.

	<b>TORNVIKEN open cabinet.</b> 9x14 3/4 x 15" Gray <u>803.590.28</u> Off-white <u>003.590.32</u>		<b>VADHOLMA open storage, brown/stained ash.</b> 9x14 3/4 x 15" <u>203.743.43</u> 9x14 3/4 x 30" <u>003.743.44</u> 9x14 3/4 x 40" <u>703.743.45</u>
	9x14 3/4 x 30" Gray <u>203.590.26</u> Off-white <u>103.590.36</u>		<b>VADHOLMA drawer unit, 15x14 3/4 x 15".</b> Smooth-running drawers with stop, self-closing the last inches. You can view and access what's inside, as the drawers fully extends. Brown/stained ash <u>403.743.42</u>
	9x14 3/4 x 40" Gray <u>003.590.27</u> Off-white <u>303.590.35</u>		<b>VADHOLMA wine shelf, 15x14 3/4 x 15".</b> Brown/stained ash <u>503.743.46</u>

	<b>TORNVIKEN box, 7 1/2 x 13 x 5 7/8".</b> A flexible box that you can place in TORNVIKEN open cabinet and also lift out and place somewhere—like on the countertop or the dining table. Gray <u>603.590.29</u> Off-white <u>803.590.33</u>
---	---

## Roll Front cabinet

	<b>TITTEBO roll front cabinet, 24".</b> Black <u>205.692.27</u>
---	--

## Wall storage

	<b>TORNVIKEN wall shelf, 19".</b> Off-white <u>803.935.17</u>		<b>KLAVERSTRÖM wall shelf, 23 3/8 x 6 3/4 x 7 7/8".</b> Solid-oak <u>306.016.89</u>
	<b>TORNVIKEN wall shelf, 47 1/2".</b> Off-white <u>603.916.61</u>		

## MAXIMERA drawers and drawer accessories

MAXIMERA drawers fully extend, and thanks to a built-in damper they always close softly and quietly. You have complete overview and you can easily reach the smallest of utensils even at the back of the drawer. MAXIMERA drawers are available in different sizes to give you plenty of options depending on your storage needs. You can also add inner drawers to fully utilise the cabinet space.

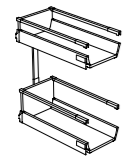

<b>MAXIMERA pull-out fitting.</b>	
W12xD24xH23½"	302.972.74

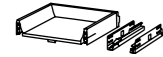

<b>MAXIMERA drawer, low. White.</b>	
W15xD14¾xH3½"	302.656.59
W18xD14¾xH3½"	502.656.58
W24xD14¾xH3½"	402.656.54
W30xD14¾xH3½"	102.656.60
W36xD14¾xH3½"	102.656.55
W15xD24xH3½"	502.656.63
W18xD24xH3½"	702.656.57
W24xD24xH3½"	702.656.62
W30xD24xH3½"	902.656.56
W36xD24xH3½"	902.656.61

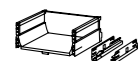

<b>MAXIMERA drawer, medium. White.</b>	
W15xD14¾xH5½"	402.656.73
W18xD14¾xH5½"	202.656.74
W24xD14¾xH5½"	402.656.68
W30xD14¾xH5½"	802.656.71
W36xD14¾xH5½"	202.656.69
W15xD24xH5½"	002.656.70
W18xD24xH5½"	002.656.65
W24xD24xH5½"	802.656.66
W30xD24xH5½"	302.656.64
W36xD24xH5½"	602.656.67

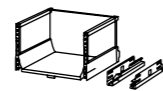

<b>MAXIMERA drawer, high. White.</b>	
W24xD17¾xH8¾"	402.766.95
W30xD17¾xH8¾"	202.766.96
W36xD17¾xH8¾"	002.766.97
W15xD24xH8¾"	302.656.78
W18xD24xH8¾"	502.656.82
W24xD24xH8¾"	102.656.79
W30xD24xH8¾"	702.656.76
W36xD24xH8¾"	102.656.84



<b>UTRUSTA drawer front, low. White.</b>	
W15xH3¾"	402.656.25
W18xH3¾"	602.656.29
W24xH3¾"	802.656.28
W30xH3¾"	202.656.26
W36xH3¾"	002.656.27



<b>UTRUSTA drawer front, medium. White.</b>	
W15xH6½"	602.656.34
W18xH6½"	102.656.36
W24xH6½"	202.656.31
W30xH6½"	002.656.32
W36xH6½"	802.656.33



<b>UTRUSTA drawer front, high. White.</b>	
W15xH8¾"	902.656.37
W18xH8¾"	702.656.38
W24xH8¾"	502.656.39
W30xH8¾"	302.656.40
W36xH8¾"	902.656.42

## Additional work surface



<b>UTRUSTA pull-out work surface.</b>	
Pull-out work surface fits SEKTION 24" base cabinet. Comes with smooth-sliding rails.	
W22½xD21½"	605.105.79



<b>UTRUSTA pull-out pantry.</b>	
Arrange your most frequently used items on the door shelves whilst still able to organize and access the less used or larger items on the pull-out shelves. Fits a SEKTION 24" wide high cabinet.	
W21¾xD22½xH49¾"	105.177.95



## UTRUSTA Shelves



<b>UTRUSTA shelf, W12xD14¾", 2 pack.</b>	
White	402.655.31



<b>UTRUSTA shelf, W12xD24", 2 pack.</b>	
White	902.655.24



<b>UTRUSTA shelf, W15xD14¾", 2 pack.</b>	
Glass	202.656.07
White	802.655.48



<b>UTRUSTA shelf, W15xD24", 2 pack.</b>	
White	602.655.25



<b>UTRUSTA shelf, W18xD14¾", 2 pack.</b>	
Glass	002.656.13
White	802.655.29



<b>UTRUSTA shelf, W18xD24", 2 pack.</b>	
White	202.655.32



<b>UTRUSTA shelf, W21xD14¾", 2 pack.</b>	
White	602.655.30



<b>UTRUSTA shelf, W21xD24", 2 pack.</b>	
White	202.655.27



<b>UTRUSTA shelf, W24xD14¾", 2 pack.</b>	
Glass	002.656.08
White	102.655.23



<b>UTRUSTA shelf, W24xD24", 2 pack.</b>	
White	002.655.33



<b>UTRUSTA shelf, W30xD14¾", 2 pack.</b>	
Glass	802.656.09
White	502.655.35



<b>UTRUSTA shelf, W30xD24", 2 pack.</b>	
White	002.655.28



<b>UTRUSTA shelf, W36xD14¾", 2 pack.</b>	
Glass	402.656.11
White	402.655.26



<b>UTRUSTA shelf, W36xD24", 2 pack.</b>	
White	802.655.34



<b>UTRUSTA shelf for corner base cabinet, white.</b>	
W38"	706.024.89
W50"	605.967.66



<b>UTRUSTA shelf for corner wall cabinet, W26".</b>	
Glass	802.656.14
White	702.656.19



<b>UTRUSTA reinforced ventilated shelf, W30xD24".</b>	
White	704.873.47

## UTRUSTA Corner interior



<b>UTRUSTA wall corner cabinet carousel.</b>	
Ø24"	802.656.47

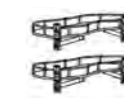

<b>UTRUSTA corner base cabinet pull-out fitting.</b>	
W50"	505.967.62



<b>UTRUSTA corner base cabinet carousel.</b>	
Ø34½"	606.018.00



<b>New</b>	
<b>UTRUSTA sink cabinet pull-out fitting.</b>	
W13¾xD11½xH17"	606.123.99

## UTRUSTA wire basket



<b>UTRUSTA wire basket.</b>	
W15xD24"	802.656.52
W18xD24"	202.656.50
W24xD24"	002.656.51

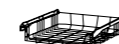

<b>UTRUSTA cleaning interior.</b>	
Pull-out organizers make it easy for you to see and reach your cleaning supplies.	
W13xD20⅞xH52½"	105.808.24

## SEKTION system fittings and hinges

Even the smaller details are important when you are planning a complete kitchen. It all depends on your needs and wishes — but maybe it's just this small part that will make a big difference.



**SEKTION suspension rail, 84".**

Galvanized 602.615.27



**SEKTION ventilation grill, 16 $\frac{7}{8}$ ×3 $\frac{3}{4}$ ".**

Stainless steel 702.561.77

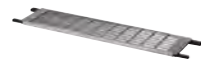

**MAKRILLA ventilation toe kick for built-in refrigerator, 20 $\frac{1}{8}$ ×4 $\frac{1}{2}$ ".**

Stainless steel 403.238.09



**NYTTIG ventilation toe kick for built-in dishwasher, 24×3 $\frac{3}{4}$ ".**  
Use with FLÅBODA panel ready dishwasher.

Stainless steel 505.929.24



**UTRUSTA push opener, electrical.** You can open the waste sorting bin with the push of a finger – or use your hip, knee or foot if your hands are busy.

302.387.03



**UTRUSTA push opener, 2-p.** Push to open; no handles needed.

802.302.24



**VARIERA cover cap, 100-p.** Covers drill holes in the glass door cabinet or open shelf. Suitable for all products with 5 mm holes.

White 002.263.15



**UTRUSTA hinge for built-in refrigerator cabinet 95°, 2-p.**

You can easily mount the door in the right position, the hinges are adjustable in height, depth and width.

202.046.47



**UTRUSTA hinge 95°, 2-p.** Fits SEKTION corner base cabinet 50×26".

806.073.73



**UTRUSTA hinge 110°, 2-p.** With built-in damper.

805.248.82



**UTRUSTA hinge 153°, 2-p.** With built-in damper. The extra wide opening angle of 153° makes it possible to have a drawer behind a door.

104.272.62



**UTRUSTA hinge with damper for horizontal door, 2-p.**  
Door lift with catch for gentle closing included.

White 804.654.15



**UTRUSTA hinge with push opener for horizontal door, 2-p.**  
Push to open, no handle needed. Door lift with catch included.

White 404.654.17



**UTRUSTA assembly kit for pull-out pantry function.** Allows you to connect a high cabinet door to two drawers to create a pull-out pantry solution. To be completed with 1 MAXIMERA medium drawer at the top and 1 high MAXIMERA drawer at the bottom.

805.105.83



**UTRUSTA connection fitting for doors.** UTRUSTA connection fitting for doors is used to connect two doors to one, so you get a uniform look for e.g. a high cabinet.

303.669.17



**UTRUSTA connecting rail for fronts.** You can easily align the drawer front with the other doors and drawer fronts in your kitchen and create a smooth, streamlined look with the help of UTRUSTA connection rail.

202.774.36

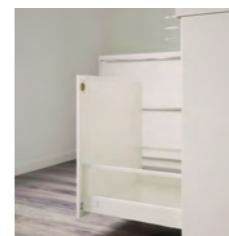

**UTRUSTA fitting for mounting drawer on door.**

002.807.55



**UTRUSTA corner fittings, 2-p.** By using the corner fitting, you can build a corner wall-cabinet solution at a 90° angle.

Galvanized 103.436.44



**SEKTION connection rail for cabinets and cover panels 2-pack.** The connection rail makes it easy for you to mount cabinets back to back, or to attach a cover panel to the back of the base cabinets.

34 $\frac{1}{4}$ " 005.570.32



**SEKTION floor anchor frame for kitchen island.** The floor anchor frame keeps the island steady on uneven floors.

L82 $\frac{5}{8}$ ×D11 $\frac{3}{4}$ " 105.570.36



**VAGLIG connection rail for panel-ready dishwasher.**

205.910.25

# SEKTION interior fittings and organizers

---

## Hidden helpers

With SEKTION interior fittings and organizers, you can get the look you want on the outside without revealing what's inside. The cabinets can be hiding all sorts of kitchen surprises. Behind a door you can find pull-out organizers for your cleaning equipment, organizers keeping all your pots, pans and lids in perfect order, or a great bunch of fully extendable drawers making everything easy to reach. Not to mention drawers inside drawers allowing you to utilize the cabinet space to a maximum. It's really up to you what goes inside your kitchen cabinets.

On the following pages you'll find numerous handy helpers making your daily work in the kitchen so much easier.

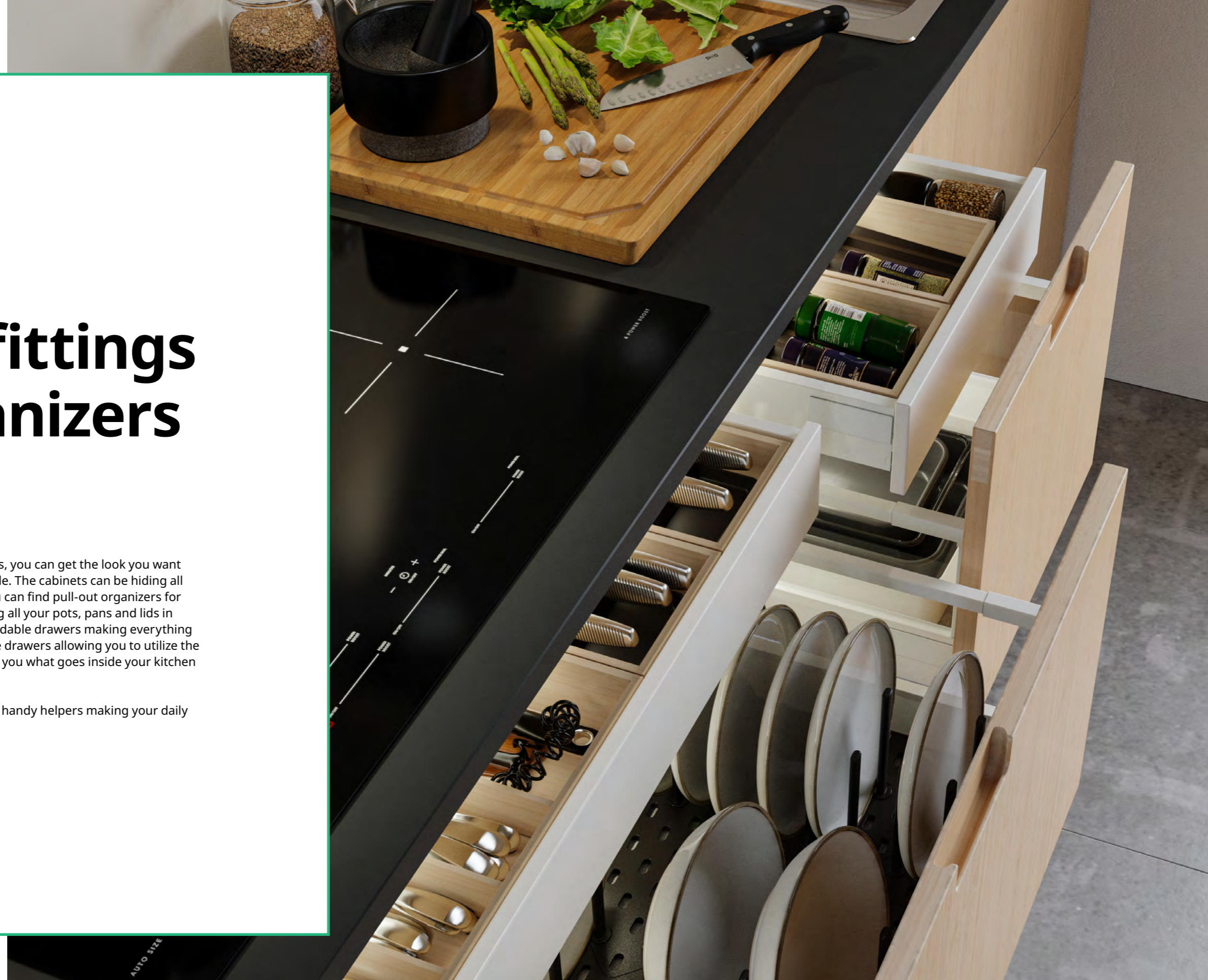

## Create the perfect combination for your drawers

Less time searching, more time for cooking. Clever inside trays for your drawers keep cutlery and kitchen utensils organised and in place. To really make sure you can see everything in the drawer, complete with drawer lighting. See all kitchen lighting on **page 52**.

15" drawer	18" drawer	24" drawer	30" drawer	36" drawer
Inner dimensions 12" Outer dimensions 15"	Inner dimensions 15" Outer dimensions 18"	Inner dimensions 21" Outer dimensions 24"	Inner dimensions 27" Outer dimensions 30"	Inner dimensions 33" Outer dimensions 36"

## UPPDATERA interior fittings

Choose interior fittings that suit your size of drawer and your cutlery and utensils. A helpful tip is to keep things close to where they are used as this enables a smooth workflow.

### Interior for 13" deep drawers, width 6" and 15"

<td>UPPDATERA utensil tray, W6xD12".</td> <td> <td>UPPDATERA cutlery tray, W15xD12".</td> </td>	UPPDATERA utensil tray, W6xD12".	<td>UPPDATERA cutlery tray, W15xD12".</td>	UPPDATERA cutlery tray, W15xD12".
White	204.914.03	White	404.914.02
Bamboo	406.180.95	Bamboo	605.881.20

### Interior for 21" deep drawers, width 6"

<td>UPPDATERA utensil tray, white. W5xD18 1/2" W6xD20"</td> <td>606.138.17 604.913.64</td> <td> <td>UPPDATERA utensil tray, bamboo. W6xD20"</td> <td>206.180.96</td> </td>	UPPDATERA utensil tray, white. W5xD18 1/2" W6xD20"	606.138.17 604.913.64	<td>UPPDATERA utensil tray, bamboo. W6xD20"</td> <td>206.180.96</td>	UPPDATERA utensil tray, bamboo. W6xD20"	206.180.96
--	--	--------------------------	--	--	------------

### Interior for 21" deep drawers, width 12"

<td>UPPDATERA cutlery tray, white. W12xD20"</td> <td>704.914.10</td> <td> <td>UPPDATERA cutlery tray, bamboo. W12xD20"</td> <td>204.914.84</td> </td>	UPPDATERA cutlery tray, white. W12xD20"	704.914.10	<td>UPPDATERA cutlery tray, bamboo. W12xD20"</td> <td>204.914.84</td>	UPPDATERA cutlery tray, bamboo. W12xD20"	204.914.84
---	--	------------	---	---	------------

### Interior for 21" deep drawers, width 15"

<td>UPPDATERA cutlery tray, white. W15xD20"</td> <td>604.942.06</td> <td> <td>UPPDATERA cutlery tray, bamboo. W15xD20"</td> <td>204.913.56</td> </td>	UPPDATERA cutlery tray, white. W15xD20"	604.942.06	<td>UPPDATERA cutlery tray, bamboo. W15xD20"</td> <td>204.913.56</td>	UPPDATERA cutlery tray, bamboo. W15xD20"	204.913.56
---	--	------------	---	---	------------

### Adjustable organizers for drawers

<td>UPPDATERA cutlery tray, soft felt gray. W15xD20"</td> <td>805.441.92</td> <td> <td>UPPDATERA cutlery tray, soft felt gray. W24xD20"</td> <td>405.441.94</td> </td>	UPPDATERA cutlery tray, soft felt gray. W15xD20"	805.441.92	<td>UPPDATERA cutlery tray, soft felt gray. W24xD20"</td> <td>405.441.94</td>	UPPDATERA cutlery tray, soft felt gray. W24xD20"	405.441.94
<td><b>New</b> VARIERA adjustable cutlery tray, white. W11-17 1/2"xD18 1/2"</td> <td>806.138.16</td> <td> <td>UPPDATERA sliding spice rack, soft felt gray. W24xD5"</td> <td>005.441.86</td> </td>	<b>New</b> VARIERA adjustable cutlery tray, white. W11-17 1/2"xD18 1/2"	806.138.16	<td>UPPDATERA sliding spice rack, soft felt gray. W24xD5"</td> <td>005.441.86</td>	UPPDATERA sliding spice rack, soft felt gray. W24xD5"	005.441.86

### Spice and knife racks

<td>UPPDATERA spice rack, white. W4xD20"</td> <td>306.005.76</td> <td> <td>UPPDATERA knife rack, anthracite. W4 1/2"xD19"</td> <td>804.913.63</td> </td>	UPPDATERA spice rack, white. W4xD20"	306.005.76	<td>UPPDATERA knife rack, anthracite. W4 1/2"xD19"</td> <td>804.913.63</td>	UPPDATERA knife rack, anthracite. W4 1/2"xD19"	804.913.63
--	---	------------	---	---	------------

## Additional interior fittings and organizers

### Box organizers

Keep things separated and easy-to-access with boxes you can lift out and carry. They're great for dry goods and loose items, like all your take-out menus.



### Shelf inserts

Make the most out of your space by adding a few shelf inserts, utilizing all the space between the shelves in your upper cabinets.



### Pot lid organizer

Less time searching for the right lid. Keep your lids organized and handy with an extendable rack.



**1. UTRUSTA towel rail, 6¼"**. It's easy to access towels because it pulls out.  
White 502.472.16



**2. UPPDATERA box, L9½×W6¾×H4¼"**.  
Anthracite 206.105.52  
Red-brown 606.105.50  
Gray-blue 006.105.48  
White 205.464.67



**3. UPPDATERA box, white.**  
L13¼×W9½×H5¾" 405.464.71



**4. UPPDATERA divider for drawer, white.**  
L15×H7¾" 804.914.43  
L24×H4¾" 604.914.44  
L30×H4¾" 304.914.45



**5. MAXIMERA add-on side for drawer, medium, glass. 2-pack**  
D14¾" 702.388.62  
D24" 302.388.59



**6. MAXIMERA add-on side for drawer, high, glass. 2-pack**  
D24" 502.388.58



**7. UPPDATERA plate holder, recycled plastic/anthracite.**  
W6-9" 704.861.78  
W7-12" 504.861.79



**8. UPPDATERA cutlery caddy, W4¾×D4¾×H9½"**.  
Anthracite 404.331.05



**9. UPPDATERA pegboard drawer organizer, anthracite.**  
W18¾×D19¾" 405.541.16  
W25×D19½" 505.029.85



**10. UPPDATERA box 3 pk, soft felt.**  
Gray 305.497.95



**11. VARIERA storage turntable, Ø10¼"**.  
White 105.361.57



**12. VARIERA pot lid organizer, stainless steel.**  
L3¼-19¾×W5¾×H4" 701.548.00



**13. VARIERA bag dispenser.** Ideal for storing things like reusable bags, toilet/kitchen rolls, gloves and socks.  
White 800.102.22



**14. VARIERA drawer mat. L59¼×W19¾"**.  
Transparent 800.128.53



**15. UPPDATERA drawer mat. L31×W20"**  
Gray 605.510.46



**16. VARIERA shelf and add-on insert, white.**  
W12½×D5½×H6¼" 801.366.22  
W12½×D11×H6¼" 601.366.23  
W17½×D5½×H6¼" 405.429.58  
W17½×D11¾×H6¼" 805.429.61



**New**  
**17. VARIERA bottle rack, W10¼×D9¾"**.  
Bamboo 606.047.14



**18. BEKVÄM spice rack, L15¾×W37¾×H3½"**.  
Aspen 204.871.75



**19. RISATORP basket, L9¾×W10¼×H7"**.  
Pink 805.886.90  
White 902.816.18  
Dark gray 205.887.11



## Waste sorting

Our easy-to-clean bins are available in a variety of sizes so you can create the waste sorting solution that suits your needs. Pull-out functions can help make recycling and composting less of a chore.

### Pull-out waste sorting tray

Make tossing things out and taking the bin to the curb more convenient.



### Recycling centre

Have two large bins for recycling paper, plastic, bottles and cans conveniently in your kitchen.



## Waste sorting combinations

Choose the combination that best fits your needs. You can use waste bins behind cabinet doors or in high drawers.

24-30-36" cabinet with door/doors

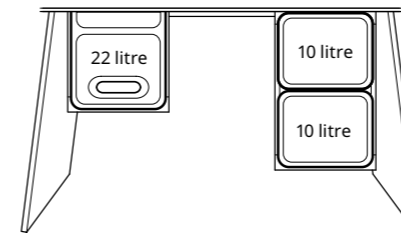

Behind cabinet doors, 36".

**HÅLLBAR series**  
**1 × Waste sorting bin**  
 22 l. 204.202.03  
**2 × Waste sorting bin**  
 10 l. 803.980.58  
**2 × Pull-out waste sorting frame**  
 204.228.53

18" drawer

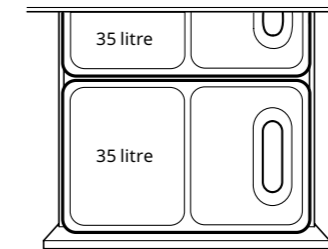

In a drawer, 18".

**HÅLLBAR series**  
**2 × Waste sorting bin**  
 35 l. 504.202.06

30" drawer under sink

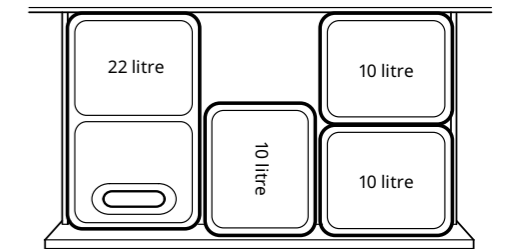

In a drawer under sink, 30".

**HÅLLBAR series**  
**1 × Waste sorting bin**  
 22 l. 204.202.03  
**3 × Waste sorting bin**  
 10 l. 803.980.58

## HÅLLBAR waste sorting



**HÅLLBAR pull-out waste sorting frame**

L10<sup>3</sup>/<sub>8</sub>×W17<sup>3</sup>/<sub>4</sub>×H12<sup>3</sup>/<sub>8</sub>" 204.228.53



**HÅLLBAR waste sorting bin, light gray.**

10 l. L10<sup>3</sup>/<sub>8</sub>×W8<sup>3</sup>/<sub>8</sub>×H12<sup>3</sup>/<sub>8</sub>" 803.980.58



**HÅLLBAR waste sorting bin, light gray.**

22 l. L15<sup>1</sup>/<sub>4</sub>×W10<sup>3</sup>/<sub>8</sub>×H12<sup>3</sup>/<sub>8</sub>" 204.202.03



**HÅLLBAR waste sorting bin, light gray.**

3 l. L7<sup>7</sup>/<sub>8</sub>×W6<sup>3</sup>/<sub>8</sub>×H6<sup>3</sup>/<sub>4</sub>" 904.321.94



**HÅLLBAR waste sorting bin, light gray.**

35 l. L15<sup>1</sup>/<sub>4</sub>×W9<sup>7</sup>/<sub>8</sub>×H21<sup>1</sup>/<sub>8</sub>" 504.202.06



**SKOLÄST trash can for cabinet with door, light gray.**

405.610.13



**FARMARKVAST compost bin with lid, gray-green.**

Ø7<sup>3</sup>/<sub>4</sub>".  
 4 L 905.670.03



**DAMMÄNG bin with lid, dark gray, Ø10<sup>3</sup>/<sub>4</sub>".**

8 L 005.599.84



**UTRUSTA push opener, electrical.**

302.387.03

# Lighting

## A brighter kitchen life

Good lighting is an essential part of any kitchen. That's why we offer integrated lighting series perfectly dimensioned to fit our kitchen cabinets. And they all contain long-lasting built-in LEDs which consume up to 85% less energy and last 20 times longer than incandescent bulbs. Having integrated lighting in your kitchen is a great way to show off your favourite dinnerware behind glass doors or in drawers. And, good lighting brings your cabinet doors and countertop to life too.

Get an even better kitchen life with the ability to dim, turn off and turn on light wirelessly. All you need is TRÅDFRI LED driver and remote control. Or, use the DIRIGERA hub and Home smart app to control every beam of light with your smart phone. We call it IKEA Smart Lighting.



### KITCHEN INSTALLATION

If you want we can install all your kitchen lighting for you, as a part of our Kitchen Installation service. See more on [page 5](#).



**Drawer lighting** simplifies finding what you need even during those midnight kitchen raids. Opening and closing the drawer turns the light on and off automatically.



**Countertop lighting** should give you a clean, clear view of all the work you're doing in the kitchen.



**Spotlights** provide a focused light that is good for lighting smaller areas and behind glass doors.



**Cabinet lighting** illuminates your favourite kitchen doors and creates a cozy mood light in the entire kitchen.

**MITTLED series**



MITTLED has a compact design and is easy to install as it uses only one installation cable per row of lights as each element connects to the next one.



**MITTLED LED countertop lighting.** Matches your cabinet sizes and features a compact design. To be completed with TRÅDFRI LED driver, VÅGDAL connection cord and ANSLUTA power supply cord, each sold separately. LED life time approx. 25.000 hours. Dimmable with TRÅDFRI LED driver, dimmer, and DIRIGERA hub, sold separately.

White	L12" (30.5 cm), 3.3W, 230 lm	904.725.14
	L15" (38.1 cm), 4.3W, 300 lm	104.554.34
	L18" (45.7 cm), 5.0W, 360 lm	504.554.27
	L24" (61 cm), 6.0W, 480 lm	004.554.20



**MITTLED LED lighting strip for drawers.** In an IKEA kitchen you can get lighting for all your drawers, that way you'll always be able to find what you need even during those midnight kitchen raids. Opening and closing the drawer turns the light on and off automatically. To be completed with ANSLUTA LED driver, sold separately.

White	L14" (34.3 cm), 2W, 50 lm	404.635.26
	L17" (41.9 cm), 2W, 50 lm	504.720.40
	L23" (57.2 cm), 2W, 50 lm	604.635.54
	L29" (72.4 cm), 3.5W, 100 lm	204.635.70
	L34" (87.6 cm), 3.5W, 100 lm	304.720.41



**MITTLED LED spotlight.** Provides a focused light that is good for lighting smaller areas. To be completed with TRÅDFRI LED driver and ANSLUTA power supply cord sold separately. Dimmable with TRÅDFRI LED driver, dimmer, and DIRIGERA hub, sold separately. Can be installed in its housing or integrated into coving. Ø3" (8.3 cm).

White	2.2W, 150 lm	404.536.45
Black	2.2W, 150 lm	504.721.39



MITTLED LED countertop lighting.  
L24" (61cm). 004.554.20

### Cabinet lighting



Cabinet lighting illuminates your favourite kitchen doors and creates a cozy mood light in the entire kitchen. YTBORG and TVÄRDRAG cabinet lighting all include energy saving LED and can be dimmed with TRÅDFRI LED driver, dimmer, and DIRIGERA hub.



**YTBORG LED cabinet lighting.** Provides a focused light that is good for lighting smaller areas. To be completed with TRÅDFRI LED driver and ANSLUTA power supply cord, sold separately. Dimmable with TRÅDFRI LED driver, dimmer, and DIRIGERA hub, sold separately.

Black	2W, 150 lm	105.278.98
White	2W, 150 lm	505.168.31



**TVÄRDRAG LED cabinet lighting.** Provides a focused light that is good for lighting smaller areas. To be completed with TRÅDFRI LED driver and ANSLUTA power supply cord, sold separately. Dimmable with TRÅDFRI LED driver, dimmer, and DIRIGERA hub, sold separately.

Black	2W, 130 lm	405.168.41
-------	------------	------------

### IKEA Smart lighting



With the DIRIGERA hub you can control all your TRÅDFRI driver connected lighting via the IKEA Home smart app or your voice assistant. Create moods and set scenes together with other IKEA Smart lighting.

**New**



**BILRESA remote control.** With BILRESA wireless remote control, you can dim your lighting connected to the TRÅDFRI driver without a wired-in installation. Batteries sold separately; 2 pcs AAA required.

Dual button	806.178.76
Scroll wheel	706.174.57



**ANSLUTA power supply cord.** For connection to the electrical outlet of 1 or up to 10 connected TRÅDFRI LED drivers. Press the cord switch to turn them all on and off simultaneously. White.

L11' 6" (3.5 m)	301.214.11
-----------------	------------



**DIRIGERA hub for smart products.** With more than one smart product from IKEA, the DIRIGERA hub, together with the IKEA Home smart app, brings the most benefits to your smart home. Improving the IQ of your home makes life itself smoother. If you want to use a voice assistant, you can connect to Amazon Alexa, Apple Home, or Google Home through integrations in the IKEA Home smart app.

White	505.034.14
-------	------------



**ANSLUTA intermediate connection cord.** Allows you to connect up to 10 TRÅDFRI LED drivers with only one connection to the electrical outlet. White.

L79" (2 m)	601.199.25
------------	------------



**TRÅDFRI LED driver.** To be completed with ANSLUTA power supply cord, sold separately. Can be used with STYRBAR remote control and DIRIGERA hub.

Up to 10W	103.561.89
Up to 30W	603.426.61



**VÅGDAL connection cord.** Used to connect MITTLED countertop lighting with TRÅDFRI LED driver. If you mount several MITTLED countertop lighting groups, you need 1 VÅGDAL connection cord for each group of lighting strips to connect the lighting to TRÅDFRI LED driver.

L11' 6" (3.5 m)	704.636.00
-----------------	------------

# Countertops

Your kitchen is the heart of your home, it's a room for everyone! How it performs and how it looks are two important factors. Even though doors and drawer fronts are the main style decision you make when updating your kitchen, your countertop can have a big impact on the overall look. However, the perfect countertop is not just about completing the look of your kitchen, it has an impact on its functionality too. When picking the right countertop there are many factors to consider, including your style, durability, maintenance, lifestyle and cost. Our countertops are available in pre-cut and custom made as well as in durable materials, finishes and thicknesses. Each surface has unique properties, with differing levels of water, wear and heat resistance.

## How to choose your countertop:

1

**What's your budget?**  
A stylish look does not have to cost a fortune, our countertops are available in wide range of materials and expressions, pre-cut as well as custom-made to perfectly fit your style, needs and wallet.

2

**What kind of material do you prefer?** When deciding on material, consider how robust you need your countertop to be, how much you are prepared to look after it, and how you want it to look in your kitchen scheme.

3

**Custom made countertops** are made-to-fit your kitchen layout, you can order the exact size you need, as well as cut-outs for your sink, faucet and cooktop. Pre-cut countertops are available in different sizes, you can take them home today and cut to desired length.

### Built to last

When we test our countertops we put them up against everything they'll face in your kitchen: liquids, oil, steam, heat, thumps, bumps and scratches. Once we're done we're so sure our countertops will last for many years to come.



## Materials

### Laminate

Laminate countertops are durable, affordable and easy to maintain, with lots of colours and expressions to choose from. Spills and grease are easy to wipe clean and the countertop keeps its beauty over time making it a practical solution.

### Wood

Wood countertops offer the natural colour and grain of wood which adds warmth to your kitchen and makes each countertop unique. Normal variations in colour, texture and appearance are due to the size and age of the tree and gives the countertop a personal character. Wood countertops are hard-wearing and can be sanded and treated when needed.

### Glass composite

Our glass composite countertops are our most sustainable offer within the composite stone material segment and is made from recycled glass. Inspired by nature, the durable, non-porous surface offers a sleek and expressive look that is stain and moisture resistant and easy to keep clean.

Colour overview



We offer pre-cut laminate counter tops in two lengths. Choose between the many colours and expressions to find the perfect look. The laminate counter tops can be cut into the length you need and finished with the edge strip included in the package.

**25**

25 year limited warranty



White

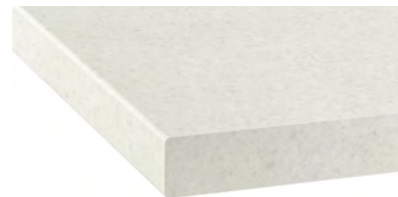

White/light gray stone effect

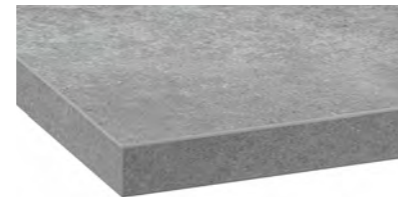

Light gray concrete effect



Gray beige stone effect



Plywood effect



Terracotta effect



Oak effect



Brown walnut effect

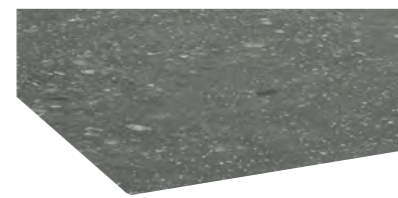

Gray terraz effect



Dark gray stone effect



Black

Laminate countertops 1 1/8" thick



1 1/8" countertops; (except MÖCKLERYD) create a light, contemporary feel and are often used in modern-style kitchens.

**🚚 They are all available to take home today.**



MÖCKLERYD countertop, white.

L48 3/4 x D25 5/8 x H7/8" 505.913.83



JÄRSTORP countertop, white.

L74 x D25 5/8"	005.896.55
L98 x D25 5/8"	805.896.56
L74 x D42"	605.896.57



EKBACKEN countertop, gray beige stone effect.

L74 x D25 5/8"	206.043.15
L98 x D25 5/8"	006.043.16
L74 x D42"	506.043.14



**New**  
EKBACKEN countertop, light gray concrete effect.

L74 x D25 5/8"	006.162.77
L98 x D25 5/8"	806.162.78
L74 x D42"	606.162.79



EKBACKEN countertop, plywood effect.

L74 x D25 5/8"	006.090.50
L98 x D25 5/8"	806.090.51
L74 x D42"	906.090.41



EKBACKEN countertop, terracotta effect.

L74 x D25 5/8"	306.090.58
L98 x D25 5/8"	106.090.59
L74 x D42"	506.090.57



EKBACKEN countertop, brown walnut effect.

L74 x D25 5/8"	604.764.86
L98 x D25 5/8"	004.429.89



EKBACKEN countertop, gray terraz effect.

L74 x D25 5/8"	306.090.15
L98 x D25 5/8"	106.090.16
L74 x D42"	806.090.08



EKBACKEN countertop, black.

L74 x D25 5/8"	905.896.70
L98 x D25 5/8"	505.896.72

## Laminate countertops 1½" thick



A 1½" countertop creates a robust impression and can often be found in a traditional-style kitchen.

 They are all available to take home today.

**25** 25 year limited warranty

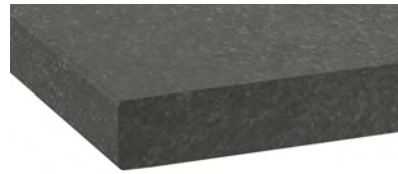

**SÄLJAN countertop**, dark gray stone effect.

L74"×D25½"	306.043.29
L98"×D25½"	106.043.30
L74"×D42"	606.043.37



**SÄLJAN countertop**, White/light gray stone effect.

L74"×D25½"	905.568.82
L98"×D25½"	705.568.83



**SÄLJAN oak effect**.

L74"×D25½"	804.392.14
L98"×D25½"	304.392.16
L74"×D42"	004.991.22

### Beautiful and durable

Laminate countertops are durable, affordable and easy to maintain. Spills and grease are easy to wipe clean and the countertop keeps its beauty over time making it a practical solution.



# Pre-cut thick veneer wood countertops



Natural and durable, wood brings a warm feeling to your kitchen and makes each countertop unique. It ages beautifully and you just sand and treat it to keep it looking great.

Pre-cut thick veneer wood countertops have a layer of solid wood covering a particleboard core. They feel and look the same as solid wood. With this technique we can create new unique expressions, using less wood and reducing the impact on the environment. We pre-treat them with a hard wax oil, so you don't have to oil them when you get them or treat them at all until the surface starts to wear. They're available to take home today.



Natural and hard-wearing, wood brings a warm feeling to your kitchen and makes each countertop unique. With thick veneer, a 1/8" layer of wood covers a particleboard core to add excellent stability.

Thick veneer countertops come in the following crafted patterns: full plank, butcher-block, fine line and chevron.

The countertops are pre-treated with hard wax oil to create an easy-care surface for immediate use. Over time, it will only look better, gaining in character. They can be sanded and treated when needed meaning that they will age gracefully.

Thick veneer countertops are available in pre-cut sizes that you take home today. They can be cut into the exact length you need and finished with the edge strip included in the package.



## Ash

Ash is a blonde hard wood with a beautiful grain pattern. Ash is a tough and strong, yet elastic material with great resilience and finishing properties. It gets gradually darker with age. In its natural form it is heavy and gives a very solid feel.



## Birch

Birch is fine-grained and pale in colour with a satin-like sheen that darkens with age. It often has knots or heartwood in cream or light brown which will give your countertop a unique and distinct natural look.



## Oak

Oak wood is exceedingly strong, heavy and durable. It is an attractive light colour with a prominent grain. Its colour ranges from light brown to a rich reddish-brown and it darkens beautifully with age.



## Walnut

Walnut wood is relatively heavy, hard and resilient. The natural colour light brown to dark chocolate brown adds warmth to your kitchen decor. Walnut gets lighter in colour with age. It has a rich variation in colour and a decorative, curved grain pattern.

### Thick veneer wood countertops Walnut



The natural colour and grain of wood adds warmth to your kitchen decor. Walnut gets lighter in colour with age. It has a rich variation in colour and a decorative, curved grain pattern.

 They are all available to take home today.



**BARKABODA** countertop, thick veneer walnut.

74×25½×1½"	103.314.72
98×25½×1½"	903.314.73



**KARLBY** countertop, thick veneer walnut.

74×25½×1½"	503.352.08
98×25½×1½"	703.352.12
74×42×1½"	302.976.41



**PINNARP** countertop, thick veneer walnut.

74×25½×1½"	004.674.75
98×25½×1½"	204.674.79

### Thick veneer wood countertops Oak



**Oak** is a very hard wood, making it a popular choice for countertops and interiors. Its colour ranges from light brown to a rich reddish-brown and it darkens with age.

 They are all available to take home today.



**VRENA** countertop, thick veneer oak.

74×25½×1½"	304.371.56
98×25½×1½"	004.371.53



**KARLBY** countertop, thick veneer oak.

74×25½×1½"	703.352.07
98×25½×1½"	903.352.11
74×42×1½"	502.976.40



**MÖLLEKULLA** countertop, thick veneer oak.

74×25½×1½"	003.011.35
98×25½×1½"	803.011.36



**SKOGSÅ** countertop, thick veneer oak.

74×25½×1½"	203.829.94
98×25½×1½"	903.829.95

### Thick veneer wood countertops Bamboo



**Bamboo** is a very hardwearing material that can withstand everyday kitchen use. The wood expression with unique grain pattern makes a warm and vibrant feeling to the room.

 They are all available to take home today.



**HOLMARED** countertop, thick veneer bamboo.

74×25½×1½"	005.573.86
98×25½×1½"	805.573.87

### Thick veneer wood countertops Ash



**Ash** is a tough and strong, yet elastic material with great resilience and finishing properties. It gets gradually darker with age.

 They are all available to take home today.



**PINNARP** countertop, thick veneer ash.

74×25½×1½"	703.723.13
98×25½×1½"	503.723.14



### Big advantages of a custom made countertops

Your custom made countertop is made to fit your kitchen layout perfectly, with the least number of seams. You can order the exact length and depth you need for your kitchen island or bar solution as well as cut-outs for your sink, faucet and cooktop.



Bar solution

Different lengths and depths

Undermounted sink

Cut-out for cooktop

Different profiles

Custom made backsplash

Hole for the faucet

# How to buy a custom made countertop

---

**1**

---

## Material and colour

Choose between laminate or quartz, then choose a colour that makes the kitchen your own.

**2**

---

## The countertop profiles

Choose the desired profile for the edges. Depending on the material you've chosen for your countertop, you have different options.

**3**

---

## Choose your sink

Choose the sink you want and if you want it top mounted or under-mounted.

**4**

---

## Take measurements

Then start to measure to see what size and shape of countertop you need. There is a helpful diagram that shows you how to measure your custom made countertop on page 72 & 74.

**5**

---

## We're here to help

To design your custom made countertop get help from an IKEA co-worker in the kitchen department at your local store.

**6**

---

## Order

To order your custom made countertop, please contact an IKEA co-worker in the kitchen department at your local store.

For more product and price information please visit [IKEA.ca](http://IKEA.ca).

## How to measure your countertop

Start by measuring your countertop from the corner where it attaches to the wall. Make sure to make your measurements alongside the wall and always start from the same point. When measuring the depth, start from the wall and measure out. Don't forget to add ½" for an overhang too.

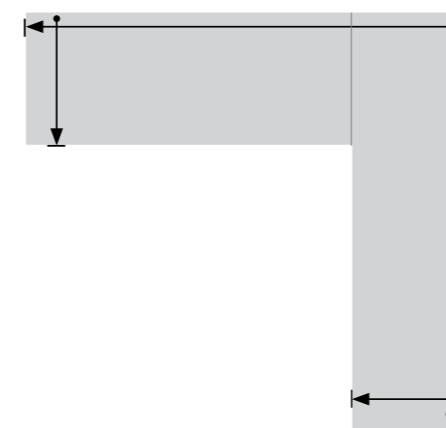

If you need to measure for a freestanding countertop (For a kitchen island for example), simply start from one end and add 1" extra for an overhang.

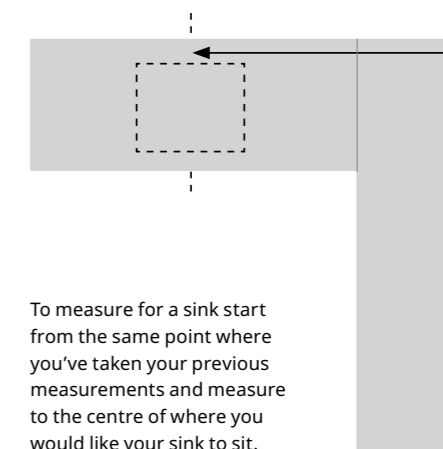

To measure for a sink start from the same point where you've taken your previous measurements and measure to the centre of where you would like your sink to sit.

## We can do it for you

Do you want a custom countertop, but feel uncertain?

Don't worry, we are here for you with the information you need. Ask for details in store or visit [IKEA.ca](http://IKEA.ca) for more information on custom made countertops

**PERSONLIG laminate custom-made countertops**



Our custom-made laminate countertops are available in a variety of colours and edge styles. Laminate countertops are stain, scratch and moisture resistant, making them easy to care for and durable too.

**Good to know**

Clean using a soft cloth or sponge and warm water with a mild, non-abrassive detergent. Avoid using scouring products.

**How to measure your PERSONLIG laminate countertop?**

Measure the length of each section of counter top. Add these measurements together to get the total amount of countertop length for your kitchen. This will help you when requesting a quote for your countertop. Minimum order may apply. See your local IKEA store or IKEA.ca for quotes.

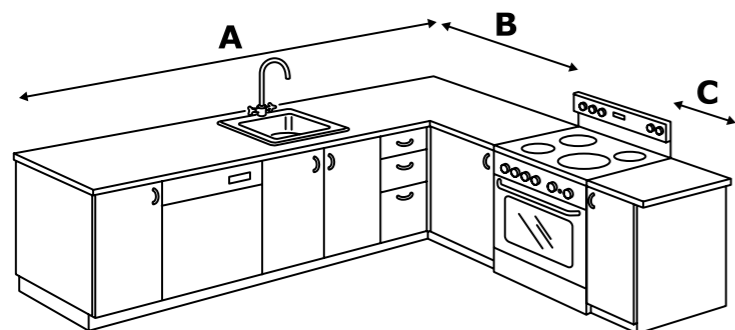

**A + B + C = X lin.ft**  
**X lin.ft × \$X/lin.ft = total price**

**What is included in a custom laminate standard order:**  
 Standard mitres up to 42", all finished ends, standard build up 3", clean cut backing or backsplash, up to 3" radius corners.  
 Standard countertop depth.  
 Additional options may apply.

**Colour Group 0:**  
 Installation service available.  
 Please inquire in-store or contact us on IKEA.ca.

Standard depth <math>26\frac{3}{4}</math>"  
 Island/Bar >27" and up to 36"\*  
 Island/Bar >36" and up to 51"\*



White

**Colour Group 1:**  
 Installation service available.  
 Please inquire in-store or contact us on IKEA.ca.

Standard depth <math>26\frac{3}{4}</math>"  
 Island/Bar >27" and up to 36"\*  
 Island/Bar >36" and up to 51"\*



Frosty White

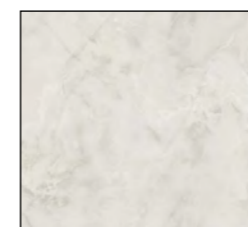

Ice Onyx

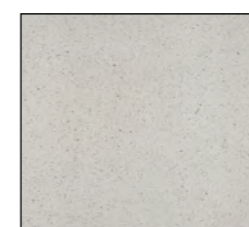

Sea Salt

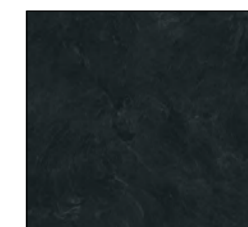

Basalt Slate

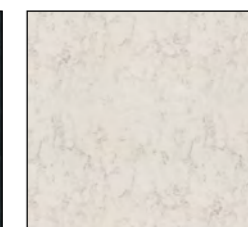

Neo Cloud

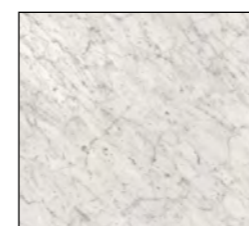

Cararra Bianco

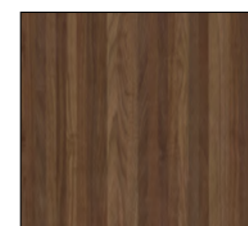

Walnut Butcherblock

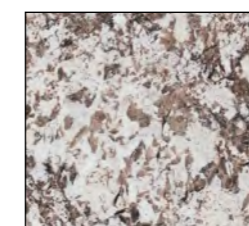

Bianco Antico



Mystique Moonlight

Available edge styles:



D Wrap



180 Wrap



Angle Wrap

\*Max depth and edge style may vary by location, please ask a co-worker for details.

**PERSONLIG laminate custom-made countertops**

**Colour Group 2:**

Installation service available.  
Please inquire in-store or contact us on IKEA.ca.

Standard depth <math>26\frac{3}{4}</math>"  
Island/Bar >27" and up to 36"\*  
Island/Bar >36" and up to 51"\*



Perlato Granite

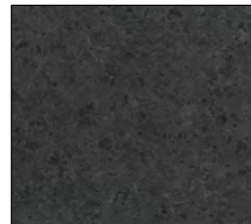

Black Shalestone

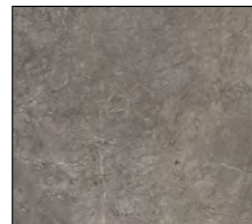

Marmara Gray

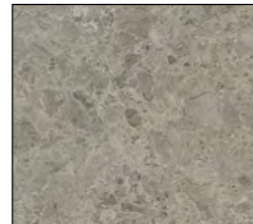

Silver Shalestone

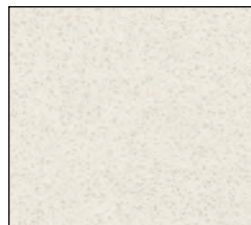

Paloma Polar

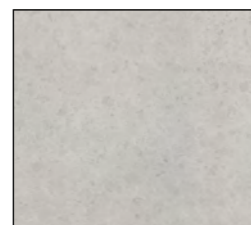

White Shalestone

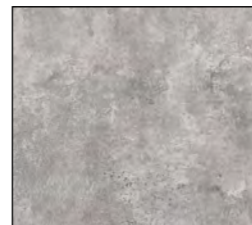

Patine Concrete

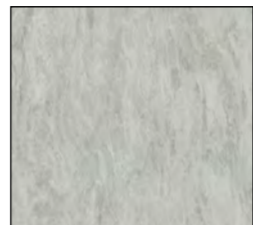

White Bardiglio

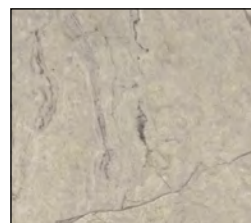

Silver Quartzite

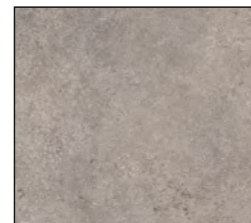

Pearl Soapstone



Oiled Soapstone



Milano Quartz

**Colour Group 3:**

Installation service available.  
Please inquire in-store or contact us on IKEA.ca.

Standard depth <math>26\frac{3}{4}</math>"  
Island/Bar >27" and up to 36"\*  
Island/Bar >36" and up to 51"\*



Pietra Grafite



Ferro Grafite

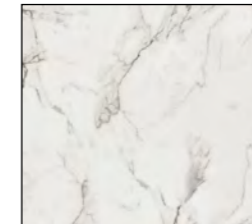

Calacatta Marble

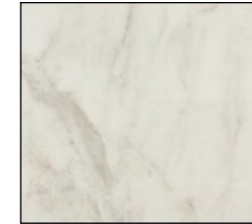

Calacatta Cava



Manhattan Marble

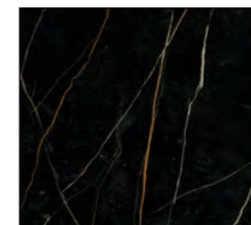

Sahara Noir



Woodland Marble

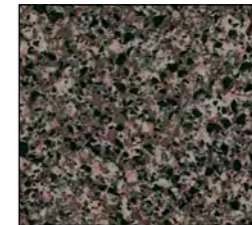

Blackstar Granite

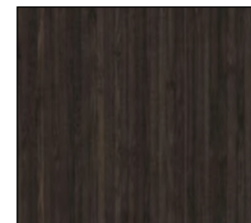

Asian Night

Available edge styles:



D Wrap



180 Wrap

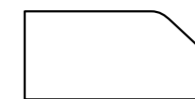

Angle Wrap

\*Max depth and edge style may vary by location, please ask a co-worker for details.

## LOCKEBO glass composite custom-made countertops



When you choose a LOCKEBO countertop you get a work surface that's extremely durable. It's scratch resistant and can withstand heavy impact. We construct our glass composite countertops with a minimum of 80% recycled material. Glass composite is smooth, non-porous and easy to keep clean. That means food and drink stains are a worry of the past. You can also order glass composite backsplashes to compliment your countertop.

For information about warranty, terms and conditions, see page 120.

### Good to know

Clean using a soft cloth or sponge and warm water with a mild, nonabrasive detergent. Avoid using scouring products.

### How to calculate the sq.ft. of your countertop

Measure the length times the depth of each section for your layout. Add the areas together to get the total sq.ft. for your countertop. See your local IKEA store or IKEA.ca for price information.

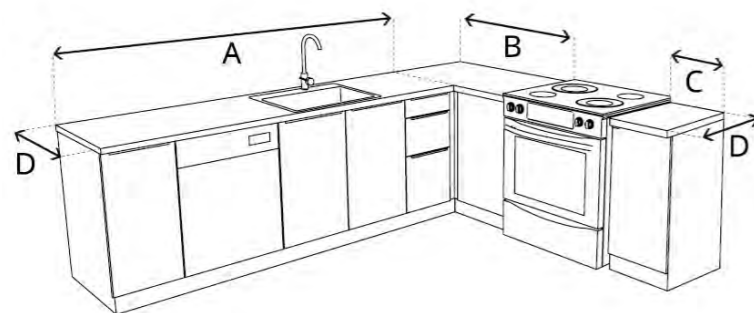

$$(A \times D) + (B \times D) + (C \times D) = \text{Total sq.ft.}$$

**What to be considered in a standard order?**  
 Countertop colour  
 Sink & faucet, style and installation  
 Finished ends or waterfall  
 Countertop edge profile

LOCKEBO glass composite countertops come with a Residential Limited Lifetime Warranty. Please contact your local IKEA store for details on the warranty or see page 120 to read more.

### Colour Group 1: 3 cm thickness

Standard depth <math>26\frac{3}{4}</math>"  
 Island/Bar >27" and up to 36"  
 Island/Bar >36" and up to 54"



Off-white/brown marble effect  
706.168.20

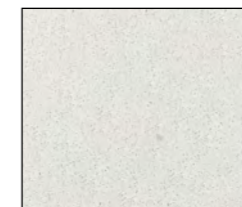

Off-white/gray concrete effect  
006.168.14

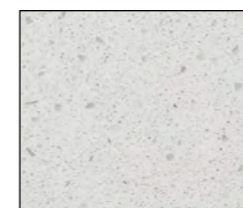

White mineral effect  
606.208.94

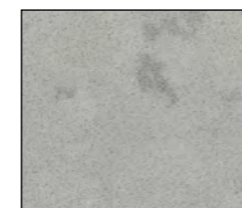

Gray stone effect  
206.208.91

Available edge styles for LOCKEBO countertops:



Straight

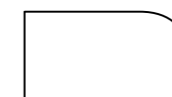

Round

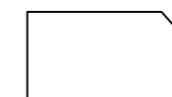

Beveled

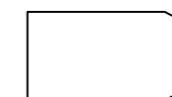

Chamfered



Full round

**LOCKEBO glass composite custom-made countertops**

**Colour Group 2: 3 cm thickness**

Standard depth <math>26\frac{3}{4}</math>"  
 Island/Bar >27" and up to 36"  
 Island/Bar >36" and up to 54"



Light-gray/white marble effect  
206.168.08



Off-white/gray marble effect  
406.168.12



Off-white/beige marble effect  
906.258.28



Light-gray/white-gray marble effect  
506.258.25



White  
306.208.95

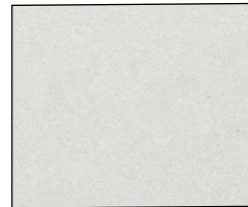

Off-white marble effect  
006.208.92

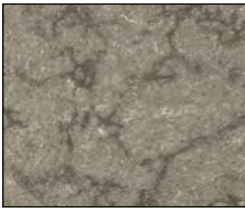

Gray marble/glitter effect  
706.351.02

**Countertop support fitting**

Secures and stabilizes kitchen countertops when there is no cabinet underneath, for example where there's a gap for appliances. Contact an IKEA co-worker for advice identifying if your solution requires a countertop support fitting.



**FIXA** countertop support fitting.  
Galvanized 702.746.28

**Colour Group 3: 3 cm thickness**

Standard depth <math>26\frac{3}{4}</math>"  
 Island/Bar >27" and up to 36"  
 Island/Bar >36" and up to 54"



White marble effect  
806.168.10

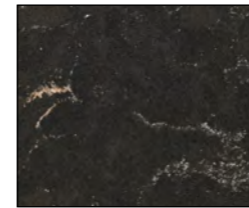

Black marble effect  
406.208.90

**Colour Group 4: 3 cm thickness**

Standard depth <math>26\frac{3}{4}</math>"  
 Island/Bar >27" and up to 36"  
 Island/Bar >36" and up to 54"



White/gray lively marble effect  
306.168.17

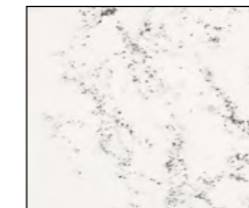

White lively marble effect  
806.208.93

Available edge styles for countertops:

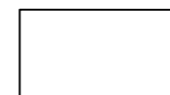

Straight

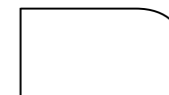

Round

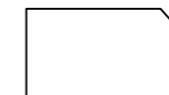

Beveled

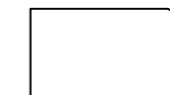

Chamfered

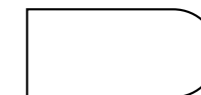

Full round

# Sinks

## A busy place in the kitchen

The sink and the area around it, is one of the busiest places in the kitchen. You use it for everything from preparing food and rinsing vegetables, to storing dirty dishes and washing up. To make the activities as easy as possible, choose a sink and sink accessories that match your needs and the way you work in the kitchen.

## How to choose your sink

**01**

How much space have you allocated for the sink? Our sink cabinets are 24, 30 or 36" wide.

**02**

Think about how you prepare food, but also how you wash up. Do you have a dishwasher or do you wash the dishes by hand? Do you need one bowl, two bowls or a sink with drainboard?

**03**

Complete your sink with sink accessories that help you organize the area in and around the sink, both when you prepare food and when you wash up (see page 80).



### PLUMBING

Let a professional connect the water to the sink and kitchen faucet you've bought from us. Then you know that everything from the strainer to pipe are where they should be — and that costly water leaks can be prevented. Read more about our services on [pages 4-5](#).

**25**

We test our sinks to ensure they can withstand the demand of everyday life in the kitchen. That's why all our sinks come with a free 25-year limited warranty (except FYNDIG). Find out more on [page 122](#).



## Our range of sinks

### Single bowl sinks

If space is an issue, one single bowl is a good option. Plus, in a big single bowl you can easily wash large pots and pans. Combine with sink accessories to make the bowl as functional as possible (see page 80).

### Double bowl sinks

Having two bowls is ideal if you have a lot going on at the same time. For example, if one of the bowls is piling up with dirty dishes, you can still rinse off vegetables and alike in the other.

### 1½ bowl sinks

A one and a half bowl sink gives you the same advantages as a double bowl sink, but in a smaller area.

### Sinks with drainboard

A sink with a drainboard is ideal for drying dishes as the sloping surface make excess water flow back into the bowl. Our sink with drainboard is reversible, so you can choose if you want the drainboard to the left or to the right.

Sink cabinet sizes

24"

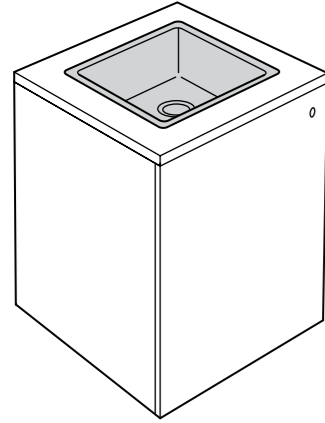

30"

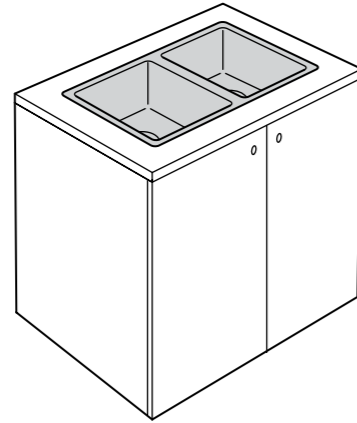

36"

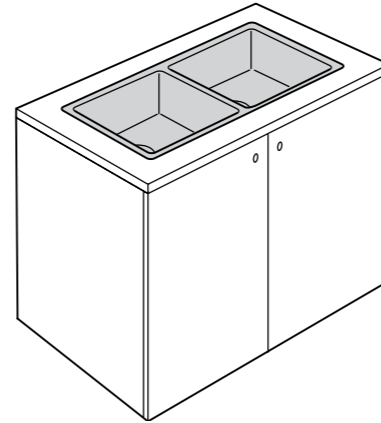

Fits 24" cabinets



**FYNDIG inset sink 1 bowl.**  
Stainless steel, a hygienic, strong and durable material that's easy to keep clean. W17¾×D15½×H5½".

Stainless steel 691.580.07



**BOHOLMEN inset sink 1 bowl.**  
Stainless steel, a hygienic, strong and durable material that's easy to keep clean. Ø17¾".

Stainless steel 891.574.98



**VATTUDALEN inset sink 1 bowl with drainboard.** Reversible; can be used with the drainboard to the right or left. Stainless steel, a hygienic, strong and durable material that's easy to keep clean. W27½×D18½×H7½".

Stainless steel 891.581.72



**LÅNGUDDEN inset sink 1 bowl.**  
Has a pre-drilled hole for a kitchen faucet. Stainless steel, a hygienic, strong and durable material that's easy to keep clean. W22×D20¾×H7½".

Stainless steel 891.574.84



**HILLESJÖN inset sink 1 bowl.**  
Can be undermounted. Stainless steel, a hygienic, strong and durable material that's easy to keep clean. W22×D18½×H7½".

Stainless steel 994.017.44



**TALLSJÖN apron front sink 1 bowl.**  
This sink with apron front in dark gray quartz composite offers a rebellious farmhouse appeal. The deep bowl design makes it easier to clean bigger pots and pans without splashing water on the floor. W23¾×D26½×H8".

Dark gray 894.913.54

Fits 24" cabinets



**VRESJÖN inset sink 1 bowl.**  
Can be undermounted. Durable stainless steel is heat and stain resistant, making it easy to keep clean. W14½×D17¼×H7½".

Stainless steel 294.257.10



**VRESJÖN inset sink 1 bowl.**  
Can be undermounted. Durable stainless steel is heat and stain resistant, making it easy to keep clean. W21½×D17¼×H7½".

Stainless steel 694.257.27



**KILSVIKEN inset sink 1 bowl.**  
Can be undermounted. The natural colour variations of the quartz make each KILSVIKEN sink one of a kind bringing a unique look to your kitchen. The surface is durable and resistant to scratches, heat, stains and impacts. W14½×D18½×H7½".

Quartz/acrylic black 993.370.22



**KILSVIKEN inset sink 1 bowl.**  
Can be undermounted. The natural colour variations of the quartz make each KILSVIKEN sink one of a kind bringing a unique look to your kitchen. The Quartz/acrylic is durable and resistant to scratches, heat, stains and impacts. W22×D18½×H7½".

Quartz/acrylic white 795.799.60  
Quartz/acrylic black 393.370.15



**HAVSEN inset sink 1 bowl.**  
Ceramic sinks are kiln-fired, which makes each sink unique. Size may vary. W21×D19×H7½".

White 192.537.28



**HAVSEN apron front sink 1 bowl.**  
Ceramic sinks are kiln-fired, which makes each sink unique. Size may vary. W25×D18¾×H8".

White 792.537.25



## Fits 30" cabinets



**HILLESJÖN inset sink 1 1/2 bowl.**  
Can be undermounted. Reversible, so you can use the sink with the large bowl on the left or right. W22<sup>3</sup>/<sub>8</sub>×D18<sup>1</sup>/<sub>8</sub>×H7<sup>1</sup>/<sub>8</sub>".

Stainless steel 991.407.04



**KILSVIKEN inset sink 1 bowl.**  
Can be undermounted. The natural colour variations of the quartz make each KILSVIKEN sink one of a kind bringing a unique look to your kitchen. The surface is durable and resistant to scratches, heat, stains and impacts. W28<sup>3</sup>/<sub>8</sub>×D18<sup>1</sup>/<sub>8</sub>×H7<sup>1</sup>/<sub>8</sub>".

Quartz/ acrylic black 993.370.17



**KILSVIKEN inset sink 1 bowl.**  
Can be undermounted. The natural colour variations of the quartz make each KILSVIKEN sink one of a kind bringing a unique look to your kitchen. The surface is durable and resistant to scratches, heat, stains and impacts. W28<sup>3</sup>/<sub>8</sub>×D18<sup>1</sup>/<sub>8</sub>×H7<sup>1</sup>/<sub>8</sub>".

Quartz/ acrylic white 495.903.94



**TALLSJÖN apron front sink 1 bowl.**  
This sink with apron front in dark gray quartz composite offers a rebellious farmhouse appeal. The deep bowl design makes it easier to clean bigger pots and pans without splashing water on the floor. W28<sup>7</sup>/<sub>8</sub>×D26<sup>1</sup>/<sub>8</sub>×H8".

Dark gray 694.913.69

## Strainer and lid for sinks

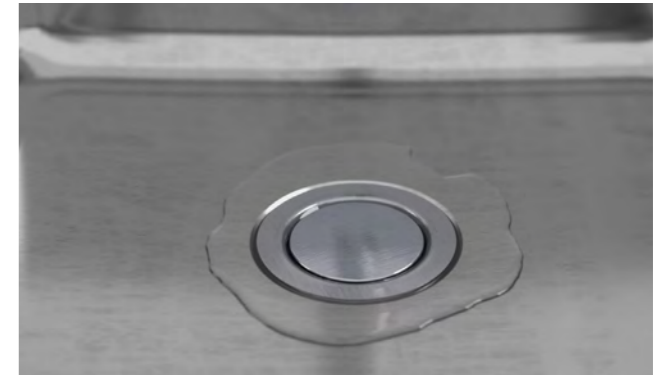

The lid attaches via a magnet and can be used as a handle for lifting the basket. The lid creates a flat surface at the bottom of the sink and prevents food waste from getting into the basket, making the sink easy to keep clean.



**LILLVIKEN lid.**  
Fits LILLVIKEN sink strainer. On top of the water trap the lid connects through a magnet which can be used as a handle to pick up the basket and throw away scraps.

Stainless steel. 203.178.52



**LILLVIKEN sink strainer.**  
Strainer and strainer basket.

Stainless steel. 503.254.26

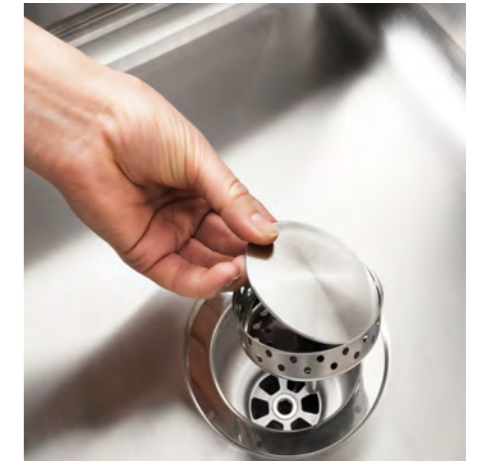

## Fits 36" cabinets



**LÅNGUDDEN inset sink 2 bowls.**  
Has a pre-drilled hole for a kitchen faucet. Stainless steel, a hygienic, strong and durable material that's easy to keep clean. W29<sup>1</sup>/<sub>2</sub>×D20<sup>5</sup>/<sub>8</sub>×H7<sup>1</sup>/<sub>8</sub>".

Stainless steel 991.574.88



**HILLESJÖN inset sink 1 1/2 bowl.**  
Can be undermounted. Reversible, so you can use the sink with the large bowl on the left or right. W29<sup>1</sup>/<sub>2</sub>×D18<sup>1</sup>/<sub>8</sub>×H7<sup>1</sup>/<sub>8</sub>".

Stainless steel 091.407.08



**VRESJÖN inset sink 1 bowl.**  
Can be undermounted. Durable stainless steel is heat and stain resistant, making it easy to keep clean. W28<sup>7</sup>/<sub>8</sub>×D17<sup>1</sup>/<sub>4</sub>×H7<sup>1</sup>/<sub>8</sub>".

Stainless steel 994.257.35

# Kitchen faucets

---

## Saving water at every step

Earth may be covered in a lot of water, but very little of it is drinkable and even less is accessible. No organism can survive without it, and no new water is created. It's constantly recycled, but our freshwater supply is overused; not evenly distributed; and impacted by pollution, contamination and climate change. That's why we equip all our kitchen faucets with a water saving aerator that reduces water use up to 40%—while maintaining the same pressure. We didn't invent aerators, but think they are an important example of how we can work together to save water for everyone's benefit.



### PLUMBING

Let a professional connect the water to the sink and kitchen faucet you've bought from us. Then you know that everything from the strainer to pipe are where they should be—and that costly water leaks can be prevented. Read more about our services on [pages 4-5](#).

10

All our kitchen faucets are tested and third party certified to meet, or exceed, the demands of the relevant national and international mechanical, quality, safety and hygienic standards. All IKEA kitchen faucets come with a free 10-year limited warranty. Find out more on [page 121](#).

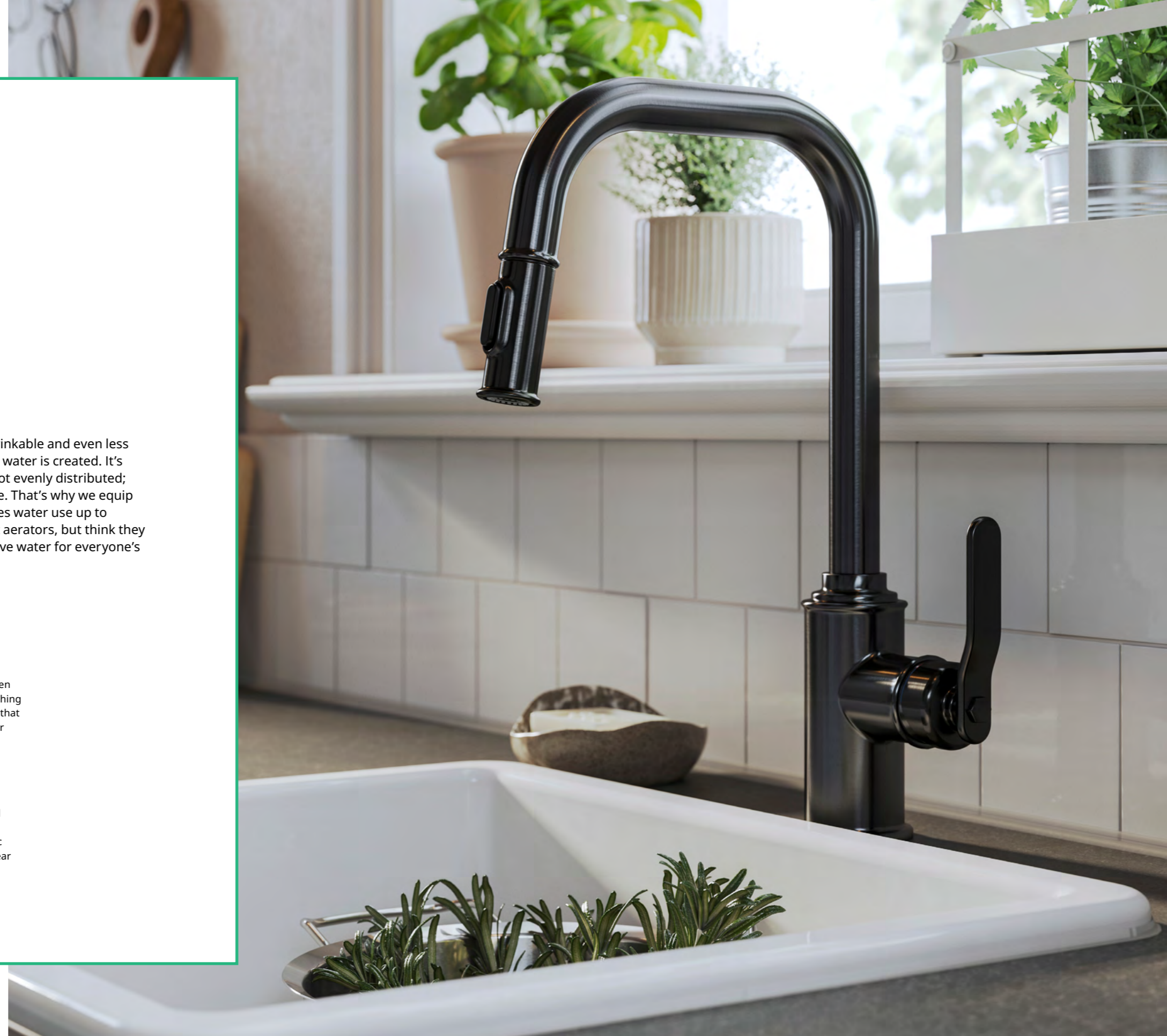

# Functions



### Kitchen faucets with low spout

Kitchen faucets with low spouts always have the handle on top, and are ideal for small single bowl sinks.

LAGAN kitchen faucet\*



### Kitchen faucets with high spout

The high spout makes it easier to wash dishes, including large pots.

ÄLMAREN kitchen faucet\*



### Kitchen faucets with pull-out spray

Rinsing dishes is easier with the pull-out spout. A counterweight makes the hose easily retract back into the kitchen faucet.

SALLSJÖN kitchen faucet with pull-out spray\*



### Kitchen faucet with pull-down spray

The kitchen faucet's sensor function is simple, hygienic and practical—perfect when you just want to fill a glass with water or rinse off your hands when cooking.

MAJSJÖN kitchen faucet with pull-down spray\*

## Kitchen faucets with high spout



**EDSVIK kitchen faucet** with dual control  
H12½". Swivel spout 360°.

Stainless steel colour 304.955.23



**ÄLMAREN kitchen faucet** H14¼".  
Swivel spout is preset to 360° but can be changed to 120°. Also available with pull-out spout.

Stainless steel colour 503.416.43  
Black 206.052.06

## Kitchen faucets with low spout



**LAGAN kitchen faucet** H6¼".  
Swivel spout: 360°.

Chrome-plated 700.850.29



**KALLSJÖN kitchen faucet** H6".  
Swivel spout 360°.

Chrome-plated 004.863.51



**New**  
**SALLSJÖN kitchen faucet** H10¾".  
Spout swivels 120°. Deck plate included.

Stainless steel colour 006.106.33



**GLITTRAN kitchen faucet** H11".  
Swivel spout: 360°.

Brass colour 804.686.83

**Kitchen faucets with pull-out spray**



**MACKSJÖN** kitchen faucet with pull-out spray. H8¾". Swivel spout 120°.

Stainless steel colour 406.013.73



**New**  
**MAJSJÖN** kitchen faucet with pull-out spray. H13½". Swivel spout 120°. Deck plate included.

Stainless steel colour 606.106.54



**New**  
**SALLSJÖN** kitchen faucet with pull-out spray. H16". Swivel spout 120°. Deck plate included.

Stainless steel colour 406.106.26



**New**  
**TAKSJÖN** kitchen faucet with pull-out spray. H15¼". Swivel spout 120°. Deck plate included.

Black 706.092.59

**Kitchen faucets with pull-down spray**



**ÄLMAREN** kitchen faucet with pull-down spray. H14¼". Swivel spout 120°. Also available without pull-out spout.

Stainless steel colour 803.416.51  
Black 406.052.05



**New**  
**MACKSJÖN** kitchen faucet with pull-down spray. H16½". Swivel spout is preset to 360° but can be changed to 120°. Deck plate included.

Stainless steel colour 806.008.33  
Brass colour 606.013.72  
Black 406.013.68



**New**  
**SALLSJÖN** kitchen faucet with pull-down spray. H19¼". Swivel spout 120° or 360°. Deck plate included.

Stainless steel colour 906.106.38  
Black 106.106.56



**New**  
**TAKSJÖN** kitchen faucet with pull-down spray. H18¾". Swivel spout 360°. Deck plate included.

Stainless steel colour 106.105.00



**New**  
**MAJSJÖN** kitchen faucet with pull-down spray. H22¾". Swivel spout 360°. Deck plate included.

Stainless steel colour 906.106.19



# ENHET open frames

---

## Keep an open mind!

In an ever-changing world, the only thing you can be certain of is that you and your home will have to change with it. The open wall frames make good use of the space above the sink and countertop, perfect for hanging utensils or placing your tableware and other things that you often use.

The choice of different frame sizes are available in white and anthracite. Open frames gives you a great opportunity to use your space efficiently Easily adaptable, and with a 10-year limited warranty, this practical and affordable choice of open frames will be your companion for years to come.

**10**

The ENHET open frames have a 10-year limited warranty. Find out more in our warranty brochure at [www.ikea.ca](http://www.ikea.ca).



## ENHET open frames

Open storage creates a dynamic and airy kitchen atmosphere. ENHET open frames allows you to express your personality through the items you choose to arrange and display on the shelves. For even more personalization opportunities, the frames come in different colours that you can mix and match any way that suits you.

Open storage also provides a good overview of all your kitchen items and you can keep the things you use the most on the shelves for easy access. With a mix of closed and open storage, it is possible to create a kitchen that doesn't only make preparing your everyday meals a breeze, but is a real eye-catcher that inspires you to cook.

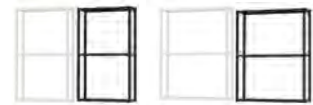

ENHET wall frame with shelves – 6" deep.

<b>18×6×30"</b>	
White	105.144.57
Anthracite	305.144.56
<b>24×6×30"</b>	
White	205.158.85
Anthracite	705.158.83



ENHET wall frame with shelves – 12" deep.

<b>18×12×30"</b>	
White	005.222.74
Anthracite	205.222.73
<b>24×12×30"</b>	
White	705.144.59
Anthracite	905.144.58



ENHET base frame with shelves.

<b>18×24×30"</b>	
White	805.144.54
Anthracite	505.144.55
<b>24×24×30"</b>	
White	205.144.52
Anthracite	005.144.53



ENHET high frame with shelves.

<b>12×12×72"</b>	
White	805.158.92
Anthracite	005.158.91



ENHET high frame with shelves.

<b>24×12×80"</b>	
White	905.144.82
Anthracite	305.144.61

## Legs for frame



ENHET legs for frame, 4½", 2-p. Fits ENHET base and high frames.

White	605.144.45
Anthracite	105.144.43

## ENHET accessories for open frames

You can easily add ENHET accessories to extend the use of your combination. And best of all – you don't have to drill.



**ENHET swivel shelf, 16×8"**. Tired of looking for those things that tend to disappear in the kitchen? You can easily solve this by attaching this handy swivel shelf to any of the wall frames in the ENHET series. You can find and reach the things you need by turning the shelf. Perfect to have as a spice rack to keep all the flavours close at hand when you are cooking.

Anthracite	205.145.60
------------	------------



**ENHET hook, 2-p.** You can hang these hooks in the grooves under the ENHET frames – or on ENHET rail for hooks that is sold separately. With these hooks, you turn unused space into practical storage space. Perfect for everything from utensils and towels in the kitchen. Hang SKATTÅN containers on the hooks to make room for even more, sold separately.

White	004.657.54
Anthracite	604.657.51



**ENHET rail for hooks.** With this rail you can utilize every inch under your ENHET frame for storage. In no time, you can create plenty of space for cutlery or utensils by adding ENHET hooks and SKATTÅN container, sold separately.

<b>18"</b>	
White	705.145.53
Anthracite	905.145.52
<b>24"</b>	
White	005.145.56
Anthracite	205.145.55



## Lighting for ENHET

### SKYDRAG series



SKYDRAG lighting kit is designed for the ENHET series . Perfect both as countertop lighting and to create ambience in the kitchen. With the TRÅDFRI driver and the wireless dimmer you can easily turn on, off and dim your lighting.



**SKYDRAG LED countertop/wardrobe lighting strip with sensor, dimmable.**

18" (45.7 cm), white	004.395.95
18" (45.7 cm), anthracite	904.396.09
24" (61 cm), white	404.396.02
24" (61 cm), anthracite	104.791.66

### SKYDRAG – perfect fit for ENHET

Lighting creates atmosphere in homes and makes everyday life easier. This LED lighting strip is specially designed for the ENHET series, but is of course just as easy to install in an existing kitchen.



**Perfect fit to ENHET kitchen K200**  
SKYDRAG/TRÅDFRI lighting kit.  
White 094.858.18



**Perfect fit to ENHET kitchen K405**  
SKYDRAG/TRÅDFRI lighting kit.  
White 994.861.30



**Perfect fit to ENHET kitchen K406**  
SKYDRAG/TRÅDFRI lighting kit.  
White 694.816.43



**Perfect fit to kitchen K204, K400**  
SKYDRAG/TRÅDFRI lighting kit.  
Anthracite 694.816.38

## Cords and IKEA LED driver



**ANSLUTA power supply cord.** With this cord, you can connect up to 10 TRÅDFRI LED drivers to the electrical outlet – and turn on, turn off and dim all of them at the same time with the TRÅDFRI wireless dimmer, sold separately.

11'6"	301.214.11
-------	------------



**ANSLUTA intermediate connection cord.** Can be used as a direct connection between TRÅDFRI LED drivers, e.g. between two sections of wall cabinets, with one single connection to the electrical outlet.

79"	601.199.25
-----	------------



**ANSLUTA LED driver with cord 19W.** Use this driver if you want turn all connected light sources on and off with a single switch.

White	904.058.45
-------	------------

## IKEA Smart lighting



With the DIRIGERA hub you can control all your TRÅDFRI driver connected lighting via the IKEA Home smart app or your voice assistant. Create moods and set scenes together with other IKEA Smart lighting.



**BILRESA remote control.** With BILRESA wireless remote control, you can dim your lighting connected to a TRÅDFRI driver without a wired-in installation. Batteries sold separately; 2 pcs AAA required.

Dual button	806.178.76
Scroll wheel	706.174.57



**DIRIGERA hub for smart products.** With more than one smart product from IKEA, the DIRIGERA hub, together with the IKEA Home smart app, brings the most benefits to your smart home. Improving the IQ of your home makes life itself smoother. If you want to use a voice assistant, you can connect to Amazon Alexa, Apple Home, or Google Home through integrations in the IKEA Home smart app.

White	505.034.14
-------	------------



**TRÅDFRI LED driver.** To be completed with ANSLUTA power supply cord, sold separately. Can be used with TRÅDFRI wireless dimmer or STYRBAR remote control, and DIRIGERA hub.

Up to 10W	103.561.89
Up to 30W	603.426.61

# KNOXHULT kitchen

## A kitchen made easy, with great value for your money

KNOXHULT kitchen units make it easier to create a kitchen to love than you may think.

The selection of units in different shapes and sizes help create a practical kitchen catered to your very needs. Add to this, they come with pre-coordinated fronts and countertops, so all you have to do is combine the units to suit your space and preferences. When you're happy with the result, personalize with your favourite sink, faucet, appliances, knobs or handles and lighting and you're ready to cook.

Inside the cabinets you have great storage possibilities for things both large and small. To create order and make efficient use of space inside cabinets and drawers in your KNOXHULT kitchen, add organizers, so you can spend less time searching and more time cooking.

KNOXHULT kitchen units offer a simple path to a great kitchen that will be your companion for years to come.

**5**

The KNOXHULT kitchen has a 5-year limited warranty. Find out more on page 121.



## KNOXHULT front and countertop expressions



**White front with oak effect countertop**

White fronts paired with oak effect countertop gives the kitchen a fresh and timeless expression that is easy to like.



**Dark gray front with white marble effect countertop**

Dark grey fronts combined with a white marble effect countertop brings a modern air to your kitchen and makes it feel warm and inviting.



**Oak effect front with white marble effect countertop**

The oak effect fronts paired with a white marble effect countertop creates a vibrant expression that adds warmth to your kitchen.



**White framed front with oak effect countertop**

Timeless white framed fronts combined with oak effect countertop creates a welcoming kitchen with a traditional appeal.

## Base cabinets



**KNOXHULT base cabinet with drawers, W15×D24×H36".** This base cabinet with 3 drawers lets you organize your kitchen essentials, using space wisely and making things easy to find. ¾ drawer extension for good overview and easy access to the content. The laminate countertop is durable and easy to maintain. With a little care, it will look good as new for many years. The cabinet and drawer fronts are covered with melamine, providing a scratch-resistant surface that is easy to wipe clean.

White	403.722.63
Dark gray	106.040.09
Oak effect	606.040.02
White frame	106.039.91



**KNOXHULT base cabinet with doors and drawer, W48×D24×H36".** This base unit can be fitted with a sink and faucet and it has convenient countertop space giving you room to prepare food as well as easy access to cookware in the cabinet underneath. With both a drawer and adjustable shelves, you can organize the space inside cabinets according to what is being stored. The unit can be assembled in two ways, with the cabinet for the sink and faucet positioned either to the left or right, depending on your needs. The laminate countertop is durable and easy to maintain. With a little care, it will look good as new for many years. Cabinets and fronts are covered with melamine providing a scratch-resistant surface that is easy to wipe clean.

White	603.722.62
Dark gray	506.040.07
Oak effect	006.040.00
White frame	506.039.89



**KNOXHULT base cabinet with doors and drawers, W72×D24×H36".** This base unit can be fitted with a sink and faucet and it has convenient countertop space giving you room to prepare food as well as easy access to cookware in the cabinets underneath. With both a drawer and adjustable shelves, you can organize the space inside cabinets according to what is being stored. The unit can be assembled in three ways, with the cabinet for the sink and faucet positioned either to the left, right or in the middle, depending on your needs. The laminate countertop is durable and easy to maintain. With a little care, it will look good as new for many years. Cabinets and fronts are covered with melamine providing a scratch-resistant surface that is easy to wipe clean.

White	003.722.60
Dark gray	306.040.08
Oak effect	806.040.01
White frame	306.039.90



**KNOXHULT corner base cabinet, W44×D24×H36".** This base unit makes good use of corner spaces, providing extra depth for working and roomy storage for larger pots and pans. The included shelf is adjustable and allows you to optimise the storage space inside the cabinet. The laminate countertop is durable and easy to maintain. With a little care, it will look good as new for many years. The cabinet and front are covered with melamine, providing a scratch-resistant surface that is easy to wipe clean.

White	703.722.71
Dark gray	906.040.10
Oak effect	406.040.03
White frame	906.039.92

## Wall cabinets



**KNOXHULT wall cabinet with door, W15×D12×H30".** This wall cabinet is ideal for creating additional storage space in the kitchen, providing easy access to often used items. The adjustable shelf allow for efficient use of space inside the cabinet. The cabinet and front are covered with melamine, providing a scratch-resistant surface that is easy to wipe clean. The door can be mounted to open left or right.

White	903.722.65
Dark gray	506.040.12
Oak effect	906.040.05
White frame	506.039.94



**KNOXHULT wall cabinet with door, W24×D12×H30".** This wall cabinet is ideal for creating additional storage space in the kitchen, providing easy access to often used items. The adjustable shelf allow for efficient use of space inside the cabinet. The cabinet and front are covered with melamine, providing a scratch-resistant surface that is easy to wipe clean. The door can be mounted to open left or right.

White	503.722.67
Dark gray	306.040.13
Oak effect	706.040.06
White frame	206.039.95



**KNOXHULT wall cabinet with doors, W30×D12×H12½".** This wall cabinet offers well-needed storage without taking up too much space. Can be completed with a range hood. The cabinet and fronts are covered with melamine providing a scratch-resistant surface that is easy to wipe clean.

White	905.002.77
Dark gray	706.040.11
Oak effect	206.040.04
White frame	706.039.93



**KNOXHULT wall cabinet with sliding doors, W48×D11¾×H12½".** This wall cabinet with sliding glass doors makes good use of wall space. You get functional storage with good overview, and the possibility to put your favourite objects on display. Adjustable glass shelves allow you to customise your storage. The cabinet is covered with melamine, providing a scratch-resistant surface that is easy to wipe clean.

White	406.040.22
Oak effect	206.240.97



## Accessories



**VARIERA adjustable cutlery tray,**  
11<sup>3</sup>/<sub>16</sub>-17<sup>1</sup>/<sub>2</sub>×18<sup>1</sup>/<sub>16</sub>".

White

806.138.16



**VARIERA utensil tray,** 5×18<sup>5</sup>/<sub>16</sub>".

White

606.138.17



**LAGAN kitchen faucet.** Single lever.  
Swivel sprout 360°. H6<sup>1</sup>/<sub>4</sub>".

Chrome-plated

700.850.29



**SMÄCKER cutlery tray,** 12×10".

Green

806.014.65



**SMÄCKER cutlery tray,** 12×10".

Gray

106.014.59



**FYNDIG single sink with strainer.** Sink in  
stainless steel, a hygienic, strong and durable  
material that's easy to keep clean. Fits cabinet  
frames min. 50 cm (21") wide. 17<sup>3</sup>/<sub>4</sub>×15<sup>5</sup>/<sub>8</sub>×5<sup>7</sup>/<sub>8</sub>".

Stainless steel

691.580.07

# SUNNERSTA MINI-KITCHEN

## Flexible and affordable

With SUNNERSTA mini-kitchen you can create an open and welcoming kitchen even if space is limited. It's also great for dorm rooms and guest houses. Use the hooks and containers to keep track of utensils, and use the cart as a utility

surface when there's a lot going on in the kitchen. By adding our TILLREDA portable induction cooktop and mini fridge, you'll have everything you need. This affordable and flexible kitchen is easy to buy, get home, install and move to new places.



**SUNNERSTA mini-kitchen,**  
W44xD22xH54¾".

403.133.63



**SUNNERSTA container,**  
white. W4¾xD4¾xH5½". Fits  
SUNNERSTA rail, cart and  
mini-kitchen.

503.037.35



**SUNNERSTA hook.**

Hook, 5-pack.

403.037.26



**LAGAN kitchen faucet.**  
Single lever. Swivel sprout  
360°. Chrome-plated. H6¼".

700.850.29



**SUNNERSTA shelf/dish  
drainer,** W14¾xD5½xH2¾".

304.439.30



**TILLREDA portable  
induction cooktop,**  
W10½xD12¾xH2¼".

104.935.20



**TILLREDA mini fridge,**  
2 cu.ft.,  
W18½xD17¾xH19¾".

204.970.23

**SUNNERSTA shelf,**  
W9¾xD5½xH2".

904.439.27



# Kitchen accessories, carts and islands

---

## A kitchen easy to live in

Your kitchen isn't fully in function until everything in it has found a place of its own. With smart organizers and accessories, you'll find what you need, when you need it.

Utilize the full area in the kitchen, even the walls. With smart wall storage often used items can be close at hand, at the same time you free up workspace.

## Your best kitchen friends

Our carts and islands boost your storage space and kitchen functionality while adding a social focal point in your kitchen at the same time.

The sink area is a busy place. We have accessories with multiple purposes that can help you utilize the area in and around the sink, supporting the workflow both when preparing food and washing up.



## Rails and accessories

Our selection of kitchen helpers gives you more work and storage space without the expense of a remodel.



### KUNGSFORS series

#### KUNGSFORS net bag.

Natural, set of 2 203.728.34



#### KUNGSFORS container, Ø4¼xH10¾".

Stainless steel 003.349.18



#### KUNGSFORS container, W9½xD4¼xH10¾".

Stainless steel 603.349.20



#### KUNGSFORS dish drainer, W23¾xD11¼xH4".

Stainless steel 403.712.25



#### KUNGSFORS rail, stainless steel.

L22" 403.349.16



#### KUNGSFORS s-hook, stainless steel.

H2¼". 5-pack. 203.349.22



#### KUNGSFORS tablet stand, stainless steel.

W10¼xD5½xH4¾" 203.349.17



#### KUNGSFORS magnet knife rack, stainless steel.

W22" 403.349.21



#### KUNGSFORS magnetic clip, stainless steel.

H3¼". 3-pack. 003.349.23



#### KUNGSFORS wall grid, W22xH10½".

Stainless steel 803.349.19



#### KUNGSFORS shelf, W23¾xD11¼".

Stainless steel 503.349.25



#### KUNGSFORS shelf, W23¾xD11¼".

Ash 903.712.23



#### KUNGSFORS suspension rail, L31½".

Stainless steel 803.348.58

### PÄLYCKE series

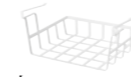

#### PÄLYCKE clip-on basket, W14¼xD10¼xH5½".

White 005.344.32

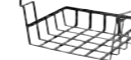

Anthracite 606.051.29



#### PÄLYCKE clip-on basket, W8¾xD10¼xH7½".

White 805.344.33



#### PÄLYCKE clip-on rack, D13".

White 905.344.37



#### PÄLYCKE clip-on hook, D5xH3".

White 805.411.55



#### PÄLYCKE clip-on towel rack, W10xD2xH4".

White 505.344.39





Rails and accessories

**SUNNERSTA series**

- 

**SUNNERSTA rail with 4 hooks/2 containers,**  
L23 $\frac{3}{8}$ ×D5 $\frac{1}{8}$ ×H5 $\frac{1}{2}$ ".  
White 404.545.60
- 

**SUNNERSTA adjustable rack with hooks,**  
W18×H17 $\frac{3}{4}$ -25 $\frac{1}{8}$ ". To be completed with  
SUNNERSTA kitchen accessories. Drill-free.  
White 204.409.51
- 

**SUNNERSTA container, 4 $\frac{3}{4}$ ×6 $\frac{3}{8}$ ".**  
White 503.037.35  
Beige 106.060.65
- 

**SUNNERSTA hook.**  
5-pack 403.037.26
- 

**SUNNERSTA shelf.**  
L9 $\frac{7}{8}$ ×D5 $\frac{1}{2}$ ×H2" 904.439.27
- 

**SUNNERSTA shelf/dish drainer.**  
L14 $\frac{3}{8}$ ×D5 $\frac{7}{8}$ " 304.439.30



**NEREBY series**

- 

**NEREBY rail, birch.**  
L23 $\frac{1}{2}$ " 904.763.43
- 

**NEREBY S-hook, 5-pack.** H3 $\frac{1}{4}$ ", H4 $\frac{1}{4}$ ".  
White 204.763.51
- 

**NEREBY wall shelf, W15 $\frac{7}{8}$ ×D4 $\frac{3}{4}$ ×H3 $\frac{7}{8}$ ".**  
Birch 904.659.24
- 

**NEREBY storage container, W3 $\frac{3}{8}$ ×D3 $\frac{3}{8}$ ×H9".**  
Natural cotton, hemp 904.290.97



## Rails and accessories



### HULTARP series

**HULTARP container, W12¼×D6¼×H4¾".**  
Black mesh 204.488.34



**HULTARP dish drainer, W15¼×D11¾×H14¾".**  
Black 604.487.66



**HULTARP container, Ø5½×H4¾".**  
Black 304.444.54  
Black mesh 704.628.27  
White/brass colour 104.628.30  
Blue/nickle plated 805.887.13



**HULTARP hook, H2¾".**  
Black 104.444.45  
Brass colour 104.487.78



**HULTARP magnet knife rack, L15×H1½".**  
Black 804.444.42



**HULTARP rail.**  
Black L23½" 004.487.69  
Brass colour L23½" 504.487.76  
Black L31½" 204.487.73  
Brass colour L31½" 304.487.77



**HULTARP paper towel holder, W6×D6×H7".**  
Black 604.444.38

## Sink accessories

Our sink accessories support all activities in and around the sink, helping you when preparing food and washing up. Plus, they help you to save both water and space, too.



### NORRSJÖN series

**NORRSJÖN colander, L16½×W7½×H3½".** The colander is designed to rest steadily on the edges of the bowl. You can use it as a colander to rinse vegetables and salad or drain pasta. Fits NORRSJÖN sinks.  
Stainless steel 003.397.13



**NORRSJÖN chopping board, L17¼×W16½".** You can place the chopping board over the sink to get more space on the countertop and to hide dirty dishes. Fits over the bowl of NORRSJÖN sinks.  
Solid Oak 604.584.49



### LILLHAVET series

**LILLHAVET chopping board, light gray.** The LILLHAVET chopping board is hollow on the inside making it lightweight and easy to move around. Polyethylene plastic.  
L18¾×W6½" 905.800.33  
L19¼×W13¾" 705.800.34



**Colander, L19×W7¼×H4".**  
Anthracite 505.034.66



**Multifunctional dish rack, L18¾×W6¾×H5½".**  
Anthracite 804.612.76



### ÖBONÄS series

**ÖBONÄS container with suction cup, W5¼×H8⅞".**  
Beige 906.060.90



**ÖBONÄS wall shelf with suction cup, W11×D4×H4¾".**  
Beige 406.061.01











**ÖBONÄS triple hook with suction cup, W2¾×H4¼".**  
Beige 806.060.95



## Kitchen islands and sideboards

Boost your storage space and kitchen functionality while adding a social focal point in your kitchen at the same time. A kitchen island or sideboard is great for many things.

	<b>TORNVIKEN kitchen island.</b> W28¾×D20½×H35¾". Off-white/oak <u>003.933.71</u>		<b>RIMFORSA workbench.</b> W47¼×D25½×H9¾". Stainless steel/bamboo <u>603.994.12</u>
	<b>TORNVIKEN kitchen island.</b> W49¾×D30¾×H35¾". Off-white/oak <u>403.916.57</u>		<b>FÖRHÖJA cart.</b> W39¾×D16¾×H35¾". Birch <u>800.359.20</u>
	<b>VADHOLMA kitchen island,</b> W31½×D24¾×H35¾". Black/oak <u>403.661.15</u>		<b>FÖRHÖJA cart.</b> W39¾×D16¾×H35¾". Birch/white <u>804.867.24</u>
	<b>VADHOLMA kitchen island,</b> W49×D31½×H35¾". Black/oak <u>203.591.54</u>		<b>RESARÖ kitchen island with drop leaf and storage,</b> W25¼×D24¾×H35¾". Solid pine <u>205.333.37</u>

## Mini kitchens













Small kitchens are great when you live in a compact space. Clever storage solutions to take care of your cooking needs. Add TILLREDA energy efficient appliances and you'll be cooking up a storm in no time.

	<b>ÄSPINGE mini kitchen,</b> W47¼×D23¾×H79¾". Black/ash effect <u>205.002.85</u>
	<b>ÖNNERUP mini kitchen,</b> W51½×D25¼×H86¼". Off-white <u>005.002.86</u>





## Carts

A cart is a quick, easy and affordable solution giving you more flexible storage space.

	<b>NISSAFORS cart,</b> W19¾×D11¾×H32¾". White <u>404.657.33</u> Black <u>203.997.77</u> Light green <u>106.067.82</u> Beige <u>405.858.01</u>		<b>KUNGSFORS cart,</b> W23¾×D15¾×H35¾". Stainless steel <u>803.349.24</u>
	<b>New</b> <b>NISSAFORS cart,</b> W71½×D19¾×H26¾". White <u>406.029.85</u> Black <u>106.029.82</u>		<b>GROERYD cart,</b> W28¾×D14¾×H31½". Bronze colour <u>304.989.46</u>
	<b>RÅSKOG cart,</b> W17¾×D13¾×H30¾". Black <u>405.821.81</u> White <u>305.867.83</u> Pink <u>706.297.14</u> Red brown <u>906.372.04</u>		<b>FÖRHÖJA cart,</b> W20¾×D16¾×H35¾". Birch/white <u>605.278.67</u>
	<b>RÅSKOG cart,</b> W15×D11×H24". Black <u>805.867.90</u> White <u>005.867.89</u> Pink <u>206.297.16</u> Red brown <u>106.372.03</u>		<b>LOSHULT cart,</b> W15×D15×H32¾". Solid pine <u>405.762.79</u>
	<b>NORRÅVA chopping board.</b> Fits RÅSKOG cart. Bamboo. W16½×D12¼" <u>005.428.61</u> W14½×D10" <u>505.917.74</u>		<b>BEKVÄM cart,</b> W22¾×D19¾×H33½". Solid beech <u>702.403.51</u>
	<b>SUNNERSTA storage unit with drawer,</b> W15×D22×H38¼". White <u>705.002.78</u>		<b>JUTTERSBO cart,</b> D14¾×H33¾". Gray-green <u>404.989.41</u>

## Step stools

	<b>BEKVÄM stepladder.</b> Solid wood, Stain, Clear acrylic lacquer. Foldable. W17¾×H24¾". Beech <u>504.846.70</u> Black <u>304.846.71</u>		<b>BÄSINGEN step stool with handle.</b> Powder coated steel and thermoplastic. W21¾×D18¾×H35¾". Black <u>405.975.02</u>
	<b>BEKVÄM step stool</b> Solid rubberwood, Stain, Clear acrylic lacquer. W16¾×D15¾×H19¾". Rubberwood <u>506.110.22</u> White <u>406.110.32</u>		

# Knobs and handles

---

## Small details that makes a difference!

Knobs and handles are like icing on the cake. Enhance the style you like, refresh the look of doors and drawers, co-ordinate with the rest of your home — or simply change because it's fun.

Knobs and handles may seem small but they can help you to really personalize your kitchen. You can enhance a style to make your kitchen look more traditional or more modern. Mix them or match them perfectly and play with placements to create the finishing touches to the look you want in your dream kitchen.



### FIXA DRILL TEMPLATE

This simple tool helps you easily and accurately mark where you want to place your knobs and handles. 903.233.93.





**BAGGANÄS knob**, black. 2-pack.  
 Ø20 mm 103.384.16  
 Ø21 mm 903.384.17



**BAGGANÄS knob**, brass-colour. 2-pack.  
 Ø20 mm 803.384.08  
 Ø21 mm 003.384.12



**BAGGANÄS knob**, stainless steel. 2-pack.  
 Ø20 mm 103.384.21  
 Ø21 mm 903.384.22



**BAGGANÄS handle**, black. 2-pack.  
 L143 mm 803.384.13  
 L335 mm 603.384.14



**BAGGANÄS handle**, brass-colour. 2-pack.  
 L143 mm 003.384.07  
 L335 mm 203.384.11



**BAGGANÄS handle**, stainless steel. 2-pack.  
 L143 mm 703.384.18  
 L335 mm 503.384.19



**GUBBARP handle**, white. 2-pack.  
 L116 mm 003.364.32



**KLINGSTORP handle**, black. 2-pack.  
 L141 mm 405.652.85



**KLINGSTORP handle**, white. 2-pack.  
 L141 mm 905.536.85

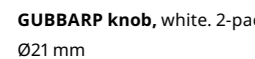

**GUBBARP knob**, white. 2-pack.  
 Ø21 mm 803.364.33

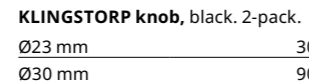

**KLINGSTORP knob**, black. 2-pack.  
 Ø23 mm 305.652.81  
 Ø30 mm 905.652.83

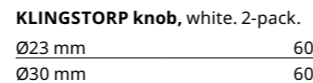

**KLINGSTORP knob**, white. 2-pack.  
 Ø23 mm 605.428.58  
 Ø30 mm 605.536.82



**STJÄRNHOV handle**, stainless steel. 2-pack.  
 L126 mm 606.096.22

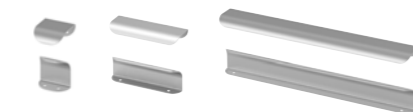

**BILLSBRO handle**, stainless steel colour. 2-pack.  
 L40 mm 603.235.92  
 L304 mm 803.236.28  
 L381 mm 603.236.29  
 L457 mm 403.236.30  
 L533 mm 203.236.31  
 L686 mm 003.236.32  
 L838 mm 803.236.33



**BILLSBRO handle**, white. 2-pack.  
 L40 mm 203.343.14  
 L304 mm 903.343.15  
 L381 mm 903.343.01  
 L457 mm 603.343.07  
 L533 mm 003.343.10  
 L686 mm 903.343.20  
 L838 mm 703.343.21

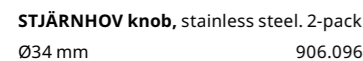

**STJÄRNHOV knob**, stainless steel. 2-pack.  
 Ø34 mm 906.096.25



**KALLRÖR handle**, stainless steel. 2-pack.  
 L213 mm 503.570.02  
 L405 mm 103.570.04



**BORGHAMN handle**, steel. 2-pack.  
 L40 mm 003.160.47  
 L170 mm 203.160.46  
 L426 mm 403.189.78



**HACKÅS handle**, anthracite. 2-pack.  
 L100 mm 303.424.79  
 L300 mm 503.424.78

**HACKÅS knob**, anthracite. 2-pack.  
 Ø15 mm 803.397.90



**ENERYDA cup handle**, black. 2-pack.  
 L89 mm 503.475.17



**ENERYDA cup handle**, chrome-plated. 2-pack.  
 L89 mm 403.475.13



**ENERYDA cup handle**, brass-colour. 2-pack.  
 L89 mm 903.475.15



**ENERYDA handle**, black. 2-pack.  
 L112 mm 703.475.16



**ENERYDA handle**, chrome-plated. 2-pack.  
 L112 mm 603.475.12



**ENERYDA handle**, brass-colour. 2-pack.  
 L112 mm 203.475.14

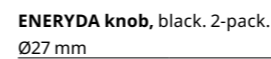

**ENERYDA knob**, black. 2-pack.  
 Ø27 mm 803.475.06

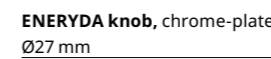

**ENERYDA knob**, chrome-plated. 2-pack.  
 Ø27 mm 003.475.10



**KALERUM handle**, stainless steel colour. 2-pack.  
 L138 mm 605.536.44  
 L266 mm 305.536.50  
 L394 mm 405.536.59



**KALERUM handle**, brass colour. 2-pack.  
 L138 mm 405.965.50



**NYDALA handle**, bronze colour. 2-pack.  
 L154 mm 806.414.85  
 L346 mm 306.414.83

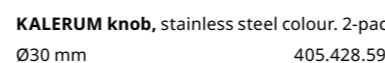

**KALERUM knob**, stainless steel colour. 2-pack.  
 Ø30 mm 405.428.59

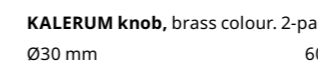

**KALERUM knob**, brass colour. 2-pack.  
 Ø30 mm 605.965.54

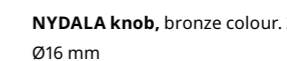

**NYDALA knob**, bronze colour. 2-pack.  
 Ø16 mm 106.414.84



**SKRUVSHULT handle**, anthracite. 2-pack.  
 L152 mm 505.059.55



**ÖSTERNÄS handle**, tanned leather. 2-pack.  
 L153 mm 403.488.95  
 L65 mm 203.488.96



**VINNÄSET knob**, Ø37 mm. 2-pack.  
 Beech 504.342.94  
 Brown stained beech 305.889.37

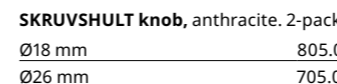

**SKRUVSHULT knob**, anthracite. 2-pack.  
 Ø18 mm 805.074.82  
 Ø26 mm 705.074.87



**ODLINGSGRÄNS knob**, Ø27 mm. 2-pack.  
 White 405.965.31  
 Gray 005.965.33



**DRAGSMARK clip-on handle**, gray-green.  
 2-pack.  
 Ø37 mm 806.060.19



**TÄRNESTAD knob**, solid oak. 2-pack.  
 Ø17 mm 205.428.60



**HAMPHULT handle**, oak. 2-pack.  
 L146 mm 406.142.43

**HAMPHULT knob**, oak. 2-pack.  
 Ø22 mm 006.142.40

**PERSONLIG/LOCKEBO**

## custom countertop overview

**1. Preparation:**

- 1.1. All base cabinets/panels must be completely and properly installed (level and flush to the wall) and all old countertops removed before a template can be done.
- 1.2. Any sink, faucet, cook top, slide in stove, etc. that requires a hole to be cut must be on site at time of templating.
- 1.3. Fabricators do not install brackets or supports for overhangs, etc.
- 1.4. All plumbing and stove connections must be disconnected and removed prior to installation date.
- 1.5. Countertop Installation Service does not include any electrical or plumbing.
- 1.6. Customer must ensure there is sufficient space through doors or openings that the countertop can fit through.
- 1.7. Apron front sink installation, a cooktop/built in oven combination or slide in stove situation requires 3 cm thick surface.

**2. Other considerations:**

- 2.1. Material will be reserved after template.
- 2.2. By purchasing a countertop with IKEA Canada, you will be asked for your name and information about how you wish to be contacted, such as email address, mobile phone number and home address. Sales transaction data is collected through the IKEA sales tools, and aggregated for the purpose of purchase behavior patterns and product interest, and will never be shared and/or sold to any third party vendors.
- 2.3. Warranty is void for builders, commercial or rental countertop installation.

**3. Cancellation:**

- 3.1. Prior to Measuring Service date, order can be cancelled and refunded by contacting IKEA Customer Service at 1-866-866-IKEA (4532).
- 3.2. Upon order status confirmation from the Countertop Fabricator, orders cancelled after Measuring Service completion but prior to countertop production will not be reimbursed the Measuring Service fee.
- 3.3. No cancellations after countertop production and or Installation Service completion.
- 3.4. For order cancellations or any questions pertaining to cancellations, please contact IKEA Customer Service at 1-866-866-IKEA (4532).
- 3.5. By paying for the IKEA Custom Countertop and Services, the customer is acknowledging and agreeing to these General Terms and Conditions.

**LOCKEBO**

## glass composite countertops

LOCKEBO glass composite materials are manufactured and supplied by Caesarstone Canada Inc.

**1. Making an appointment:**

- 1.1. A tentative installation service date will be provided and outlined on an IKEA order form. The availability of firm installation service dates will be confirmed by countertop fabricator directly with the customer.
- 1.2. Upon receipt of payment of the order, the countertop fabricator will contact the customer by phone or email within 3 business days to schedule firm service dates. If you do not hear from them within that timeframe, contact IKEA Customer Service 1-866-866-4532.
- 1.3. To make any changes to your firm countertop service dates, contact your designated countertop fabricator.

LOCKEBO glass composite:

Caesarstone 1-818-208-0126 (BC, AB), 1-877-892-5164 (MB, ONT, QC, NS)

- 1.4. Any rescheduling of your countertop service appointment must be done forty-eight (48) hours prior to the scheduled service date.
- 1.5. All countertop service appointments will be scheduled within a 3-hour window.
- 1.6. Upon the purchase of countertop, customers will receive a Pre-installation Guide for Custom Countertops to review and reference for service appointment readiness.

**2. The measuring appointment:**

- 2.1. The homeowner or designated decision maker, 18 years of age or older, must be present for the duration of the pre-installation visit. The designated decision maker will be required to approve all final measurements and sign off on a Certificate of Completion for the Measuring Service. If the fabricator cannot complete the service due to not having a person of decision-making authority present, then they will have to reschedule another service appointment. An additional trip charge will apply.
- 2.2. Fabricator reserves the right to request a customer re-schedule their Measuring Service of the service area if preliminary work has not been completed. Preliminary work consists of removal of pre-existing countertop. An additional trip charge will apply.
- 2.3. Seam locations will be discussed at time of measuring and customers will confirm by signing off on the Certificate of Completion. Fabricator reserves the right to place seams in the most structurally sound locations. Seamless countertops are not guaranteed. If a seamless countertop is possible, additional charges may apply.
- 2.4. Exact measurements of custom countertop will be determined after Measuring Service has been completed. Any variances from the original order purchased will result in a change order for the customer. IKEA Customer Service will reach out to the customer to collect or refund the monies owed to avoid holding up the order. Changes in order will be administered as follows:
  - 2.4.1. A change order form will be completed during the Measuring Service, signed by the customer and then submitted to IKEA by fabricator. IKEA will contact the customer to explain the changes, collect payment or issue a refund based on the final template.
  - 2.4.2. Change Order - Upcharges: Unpaid upcharges will place the countertop order on hold and may result in re-scheduled confirmed, material and colour will be reserved and fabrication will resume.
  - 2.4.3. Change Order - Refunds: Refunds will not hold up the order process.
- 2.5. Base cabinets must be assembled, permanently installed and levelled at the time of Measurement Service along with their corresponding installed cover panels, doors and drawer fronts.
- 2.6. During the Measuring Service, the fabricator may require a second Measuring Service date for wall panels over 4" due to the requirement of the countertop needing to be installed first. Additional service dates may impact the overall installation completion date(s).
- 2.7. A second installation date, separate from the countertop installation, will be required for wall panels over 4" in height. Any kitchen wall cabinet wall panels and/or decorative strips/light valences and faucet must not be installed to allow space for backsplash installation. If there is uncertainty about this detail, please ask at the time of your measure appointment.
- 2.8. All sinks, faucets, cooktops, stoves or any other items that would impact the countertop or wall panel measurements directly must be onsite at the time of Measuring Service.
- 2.9. Fabricator requires accessibility to parking of the service address.
- 2.10. Fabricator will not be able to complete the Measuring Service if any readiness requirements are not met. A new Measuring Service date will be rescheduled, and an additional trip charge will apply.
- 2.11. Upon completion of Measuring Service, all countertop and wall panel details signed on Certificate of Completion will be considered final and not subject to change.

**Good to know and product care**

1. The thickness of Caesarstone glass composite slabs are 3 cm with an allowable variance of +/- 1.5mm.
2. Colour may vary slightly from in-store samples.
3. Glass composite is not perfectly smooth, minor pitting is common and does not affect the performance or constitute a material defect.
4. Clean with soap and water on a regular basis. For tougher dirt, use warm water with a non-abrasive sponge and a cleaner that does not contain bleach.
5. Trivets and hot pads must be used when placing hot skillets, pans, crock-pots or other heat generating kitchenware on the surface.
6. Using cutting boards and taking care not to drop or move heavy objects on the surface will help to ensure long-lasting beauty.

**Glass composite residential lifetime warranty**

1. Original proof of purchase receipt is required.
2. Warranty against any manufacturing performed by the supplier, as well as the correct installation of the product.
3. The warranty does not protect against natural causes (ie: fire, flood, tornado, etc.).
4. Does not cover wear and tear such as stains, scratches, water spots and burns.
5. Does not cover failure to comply with care instructions.
6. Does not cover chips or damage from abuse or excessive impact.
7. Does not cover any products moved from their original place of installation.
8. Does not cover repair to electrical, tile or wall surfaces and plumbing modifications possibly required to install the custom countertop.
9. Does not cover damages from alterations performed after initial installation.
10. The warranty is effective only if the owner of the countertop is the occupant of an indoor single-family residence.
11. For full warranty details visit caesarstone.ca under Support (Limited Lifetime Warranty for residential and commercial).

**PERSONLIG**

## custom laminate

**1. Information:**

- 1.1. Minimum order 4LF.
- 1.2. Counter thickness is 11/16" without buildup while the front roll is 1¾".
- 1.3. When the customer chooses "hold for finals", final measurements must be provided to fabricator upon completion of the cabinet installation.
- 1.4. Unless installation is purchased, sink and faucet cutouts are customers responsibility.
- 1.5. Mitres may be assembled on site.
- 1.6. Do not place hot pots and pans directly on their surface. Instead, use hotplates, hot pads or even heavy towels to protect the surface.
- 1.7. Make sure to not cut directly on the surface of laminate counters.
- 1.8. Be careful with water. Too much water flooded onto a laminate countertop can cause problems with the seams. Water penetration is not covered under warranty.
- 1.9. Avoid using harsh chemicals.
- 1.10. Use mild household cleaner. Avoid using harsh abrasive cleansers. Don't use abrasive sponges or steel wool on laminate.

**Limited 1-yr warranty**

1. Original receipt is required.
2. Guaranteed against any manufacturing performed by the fabricator, as well as the correct installation of the product.
3. Limited warranty applies when product is in a residential setting and under normal use.

4. The limited warranty does not protect against natural causes (ie: fire, flood, tornado, etc.)
5. Does not cover wear and tear such as stains, scratches, water spots and burns.
6. Does not cover failure to comply with care instructions.
7. Does not cover any products moved from their original place of installation.
8. Does not cover repair to electrical, tile or wall surfaces and plumbing modifications possibly required to install the custom countertop.

**KITCHEN FAUCETS****10****What is covered under this limited warranty?**

The 10-year limited warranty is valid for all kitchen faucets at IKEA. This limited warranty applies to domestic use only and covers defects in material and workmanship in all kitchen faucets.

**What is not covered under this limited warranty?**

This limited warranty does not cover normal wear and tear, cuts or scratches, or damage caused by impacts, accidents or waterborne debris. It also does not apply to the filter/aerator which should be cleaned regularly or replaced when worn out.

**KNOXHULT KITCHEN SERIES****5****What is covered under this limited warranty?**

The 5-year limited warranty is valid for all KNOXHULT products. This limited warranty applies to domestic use only.

**What is not covered under this limited warranty?**

This limited warranty does not cover normal wear and tear, cuts or scratches, or damage caused by impacts, accidents or waterborne debris.

## WARRANTY

### SEKTION Kitchen system

25

#### What products are covered under this limited warranty?

The 25 year limited warranty applies to domestic kitchen **use** only. This limited warranty covers all of the following parts of the SEKTION kitchen system:

- Cabinet frames • Fronts • UTRUSTA hinges
- MAXIMERA fully-extending drawers • UTRUSTA shelves of tempered glass and melamine • Toe kicks
- Legs • Cover panels • Deco strips/mouldings
- Pre-cut countertops • Sinks except FYNDIG
- UTRUSTA connecting rail

#### Products not covered under this limited warranty

Knobs, handles, PERSONLIG and LOCKEBO custom made countertops, VÅGLIG connection rail, FYNDIG sinks and wall shelves in solid wood. UTRUSTA wire baskets, TUTEMO, TORNVIKEN and VADHOLMA open cabinets have a 10-year limited warranty. See also general conditions in the limited warranty folder for SEKTION Kitchen System.

#### General conditions

##### What will IKEA do to correct the problem?

IKEA will examine the product and decide, at its sole discretion, if it is covered under this limited warranty. If considered covered, IKEA through its own service operations, will then, at its sole discretion, replace it with the same or a comparable product. If the item is no longer sold by IKEA, IKEA will provide an appropriate replacement. It is IKEA that determines, at its sole discretion, what constitutes an appropriate replacement.

#### Conditions for the warranties

The warranties are valid from the date of purchase at IKEA. The original purchase receipt is required as proof of purchase.

#### Exclusions

This limited warranty does not cover custom-made countertops, normal wear and tear, cuts or scratches, or damage caused by impacts, accidents. Follow our assembly instructions and care instructions carefully. This limited warranty does not apply to products that have been stored, assembled or installed incorrectly, used inappropriately, abused, misused, altered, or cleaned with wrong cleaning methods or wrong cleaning products. This limited warranty does not apply if the products have been used for public use, outdoors or in a corrosive environment. It also does not cover accidental damage.

#### Care instructions

To be able to rely on this limited warranty you need to follow the specific care instructions for every product. You will find all care instructions in the IKEA KITCHEN limited warranty folder or with each individual product.

#### General legal rights:

This limited warranty gives you specific legal rights. This limited warranty does not, in any way, affect the rights given to you by law.

#### How to reach us if you need service:

If you have any questions regarding your IKEA kitchen please call 1-866-866-4532 or visit us online at [IKEA.ca](http://IKEA.ca). Save your sales receipt as proof of purchase. Proof of purchase is required for the warranties to be valid.





## IKEA Home Planner

Design the SEKTION kitchen of your dreams in a 3D environment and get a price on every detail as well as the total kitchen. Print out your drawings and product list at home, or save to the IKEA website. At any IKEA location you can discuss your design and get lots of advice and guidance from our kitchen experts. Learn more at [IKEA.ca/kitchenplanner](https://www.ikea.ca/kitchenplanner)



## IKEA kitchen warranty

We offer you a 25-year limited warranty on the SEKTION kitchen system along with a 5-year limited warranty on the KNOXHULT kitchen series. Kitchen faucets have a 10-year limited warranty, while the majority of IKEA appliances have a 5-year limited warranty.

Read more about the kitchen warranties on [IKEA.ca](https://www.ikea.ca).



## IKEA.ca/ Kitchens

On our webpage you'll find lots of inspiration and ideas to get the most out of your kitchen, whether it's a new one or an old that you want to freshen up. Plus, here you'll find all products that you can imagine to personalize and create the kitchen of your dreams.



## IKEA Kitchens and Appliances

In these guides you'll find all the products, steps how to plan, measure, order, deliver, and install. Choose exactly what you need to make your dream kitchen a reality.



## Installation Guide

The installation guide is available with step-by-step instructions when installing a SEKTION kitchen on your own.

You find and download all our guides and other helpful information at [IKEA.ca](https://www.ikea.ca)

## NEED HELP?

### You can contact us in different ways:

**Online:** Read the FAQs at [IKEA.ca](https://www.IKEA.ca) — they might answer your question: [IKEA.ca/FAQ](https://www.IKEA.ca/FAQ)

**In Person:** Speak to us in store — those friendly people in the yellow shirts are ready to help you through your buying process.

**By phone:** If you ever need to talk to us in person, we're happy to answer your call. You can reach us over the phone at: 1-866-866-IKEA (4532)

**Installation Services:** Save time and effort with professional installation. For full details visit [IKEA.ca/kitchenservices](https://www.IKEA.ca/kitchenservices)

This is a reference guide created to better assist customers when purchasing products. While a high level of accuracy has been sought in its preparation, we cannot guarantee that there are no errors or omissions nor will we be bound by them. Availability may vary by store. Please see an IKEA co-worker or visit [www.IKEA.ca](https://www.IKEA.ca) for more information.

