

# HAVSDJUP

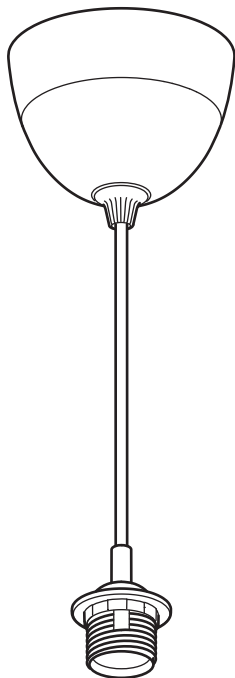

Design and Quality  
IKEA of Sweden



### **English**

INSTALLATION INSTRUCTIONS

## **CAUTION:**

Before starting, turn off power at main circuit panel.

### **Français**

INSTRUCTIONS D'INSTALLATION

## **ATTENTION:**

Coupez l'alimentation avant de procéder à l'installation.

### **Español**

INSTRUCCIONES DE MONTAJE

## **ADVERTENCIA:**

Antes de comenzar el montaje, cortar la luz en el cuadro general.

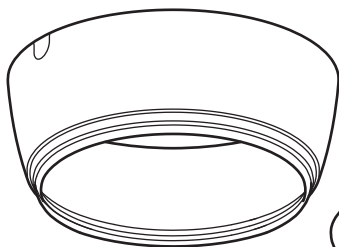
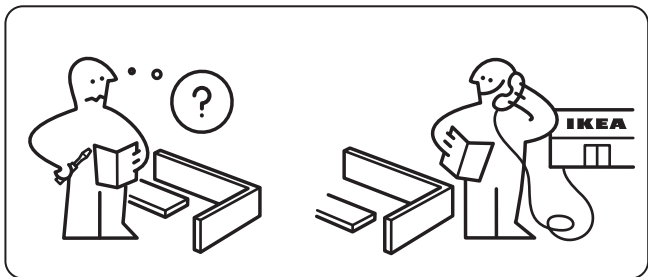

1x

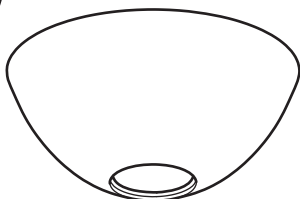

1x

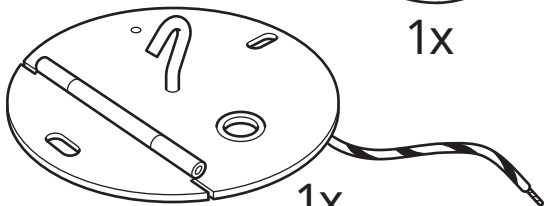

1x

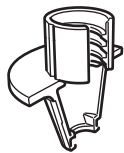

1x

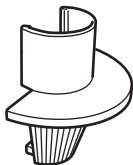

1x

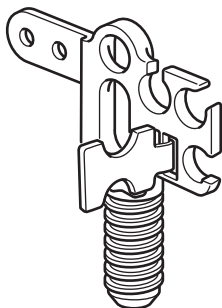

153748

1x

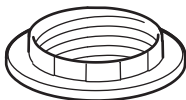

124979

1x

1

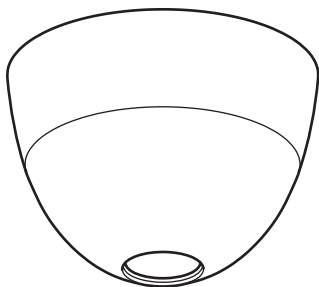
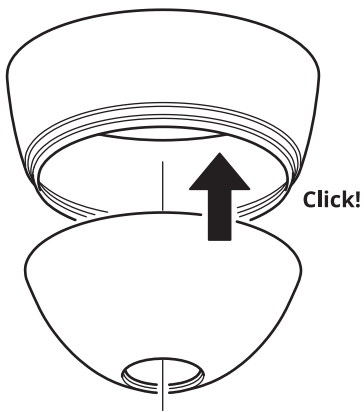

2

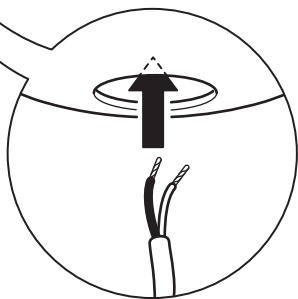
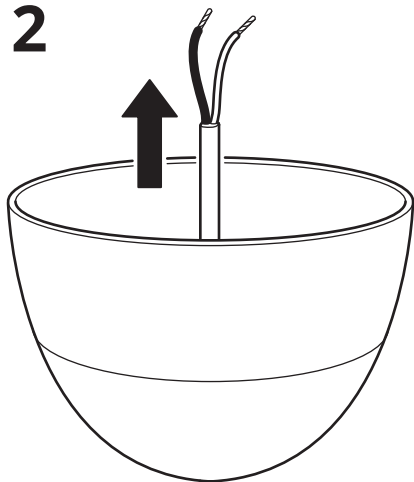

**3**

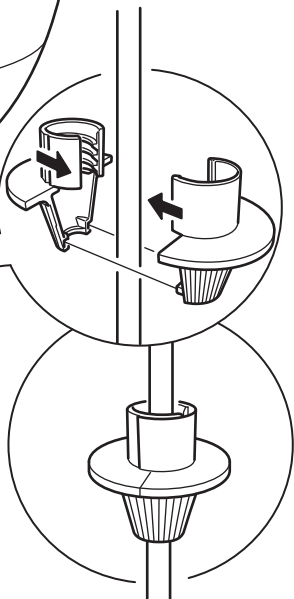
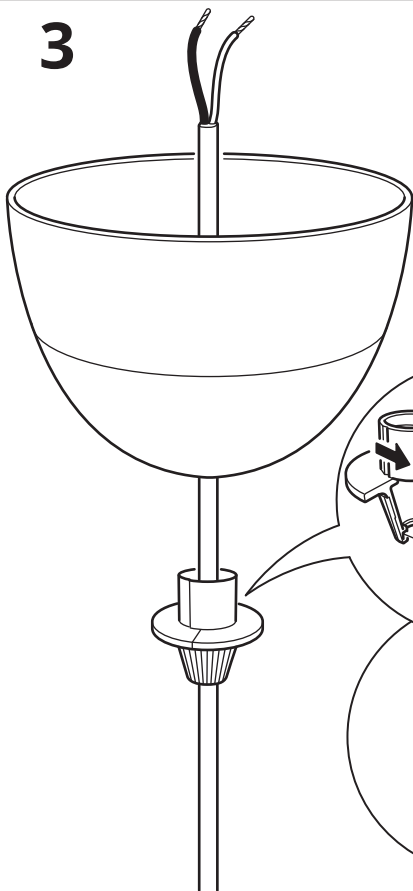

4

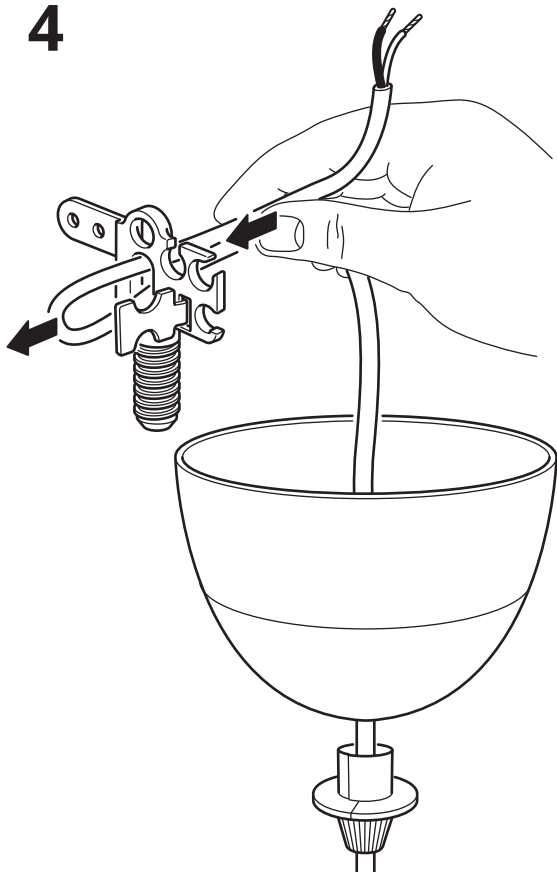



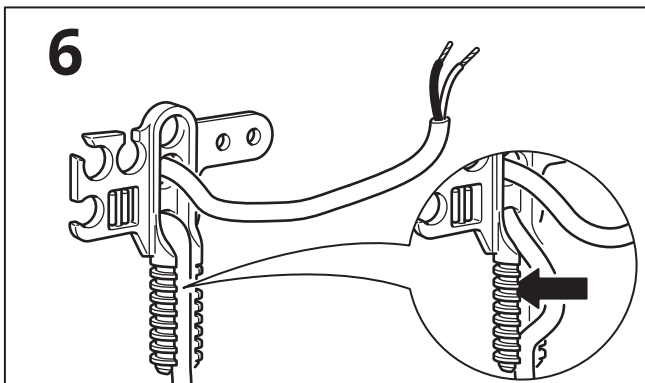
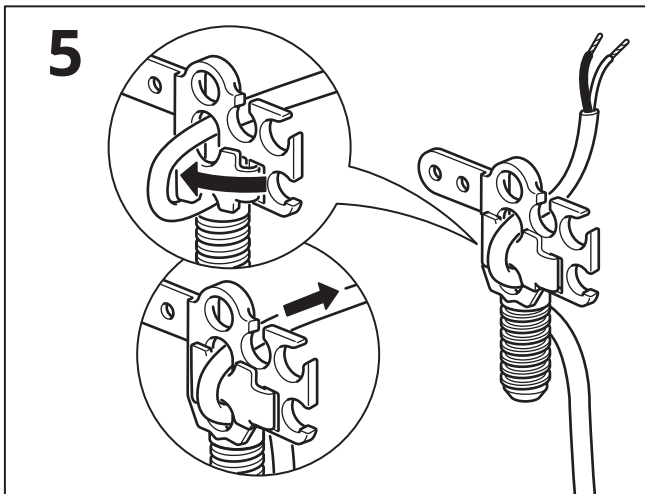

**7**

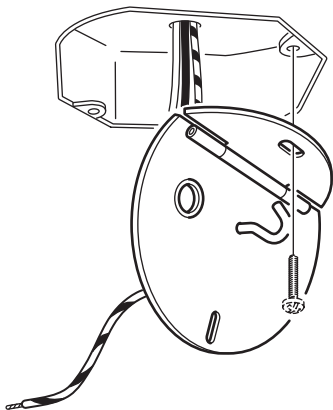

**8**

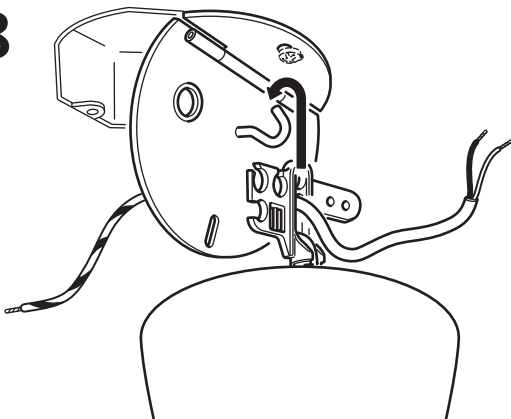

# 9



**English**  
Live

**Français**  
Phase

**Español**  
Con corriente

**English**  
Neutral

**Français**  
Neutre

**Español**  
Neutro

**English**  
Earth/  
Ground

**Français**  
Terre

**Español**  
Tierra

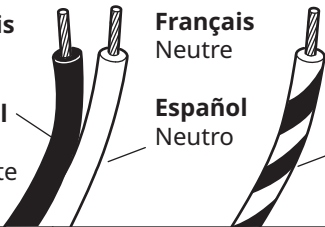

3x

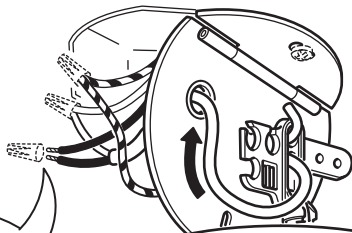
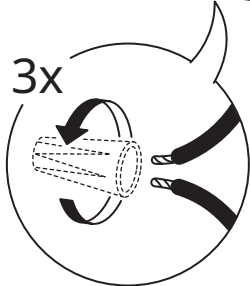

**10**

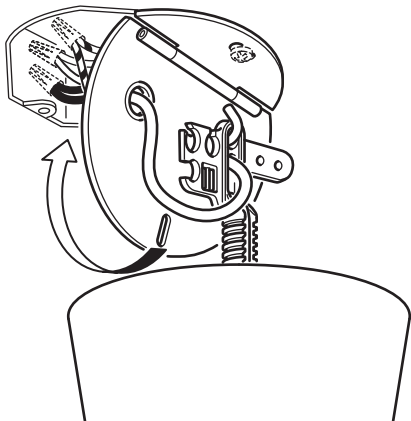

**11**

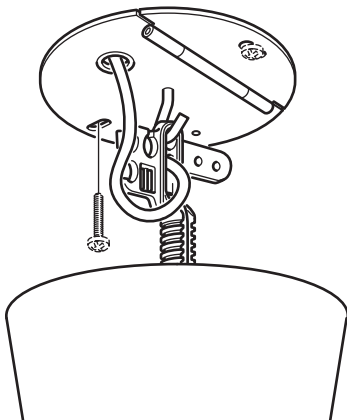

# 12

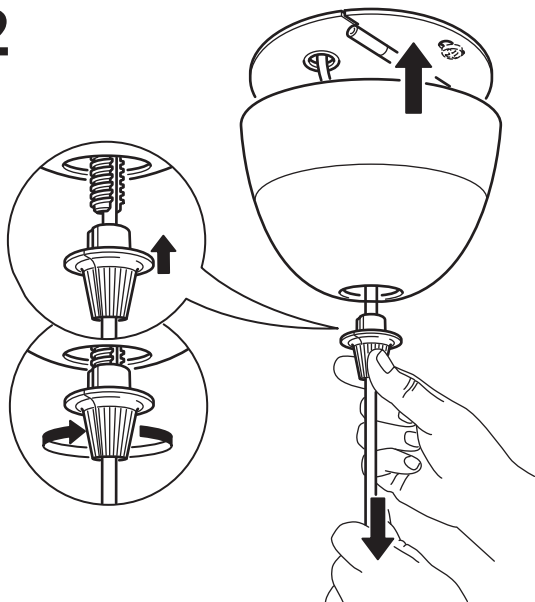

**English**  
CAUTION!  
Do not  
overtighten.

**Français**  
ATTENTION!  
Ne pas trop  
serrer.

**Español**  
¡PRECAUCIÓN!  
No apretar en  
exceso.



**English**

Max 1.5 kg/3.3 lb

**Français**

Max 1,5 kg/3,3 lb

**Español**

Máx. 1,5 kg/3,3 lb.

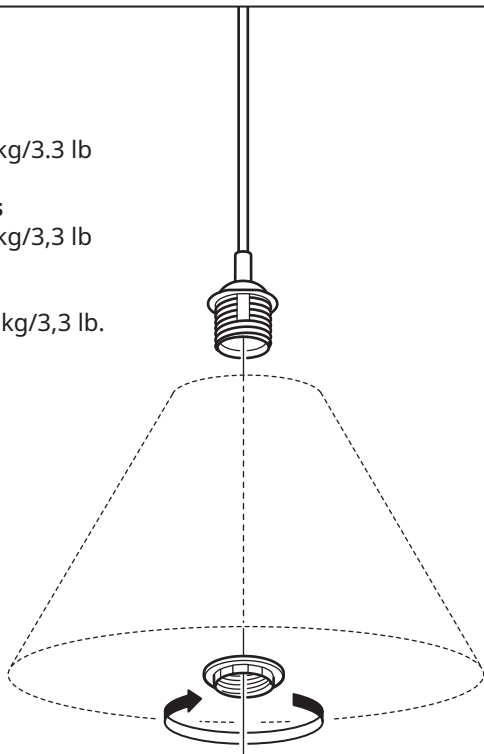



### **English**

Use only an open top open bottom lamp shade. For your safety, the dimensions of the shade must be in accordance with the minimum dimensions listed below. Use maximum 16 watt bulb.

### **English**

USE SHADES ONLY IN THE VERTICAL POSITION. ANY DEVIATION FROM THESE INSTRUCTIONS MAY CONSTITUTE A FIRE HAZARD.

### **Français**

Utiliser uniquement un abat-jour ouvert sur le dessus et sur le dessous. Pour votre sécurité, les dimensions de l'abat-jour doivent correspondre aux dimensions minimums indiquées ci-dessous. Utiliser une ampoule de 16 W maximum.

### **Français**

LES ABAT-JOUR DOIVENT ETRE UTILISES EN POSITION VERTICALE. TOUT AUTRE UTILISATION PEUT ENTRAINER UN RISQUE D'INCENDIE.



## Español

Utilizar únicamente una pantalla que sea abierta por la parte superior y la inferior. Por motivos de seguridad deben coincidir las medidas de la pantalla con las medidas mínimas indicadas más abajo. Bombilla recomendada 16W como máximo.

## Español

SÓLO UTILIZAR PANTALLAS COLOCADAS VERTICALMENTE. CUALQUIER VARIACIÓN DE ESTAS INSTRUCCIONES PUEDE ENTRAÑAR RIESGO DE INCENDIO.

