

FRILLESBO STENABY

en



Design and Quality
IKEA of Sweden



ENGLISH

Please refer to the chapter IKEA GUARANTEE for contact details of the after sales customer service centre.

ENGLISH

4

Contents

Safety information	4	Using the accessories	17
Safety instructions	6	Hints and tips	19
Installation	9	Care and cleaning	22
Product description	10	Troubleshooting	24
Control panel	10	Technical data	26
Before first use	11	Energy efficiency	26
Daily use	12	Environmental concerns	28
Additional functions	15	IKEA guarantee	28
Clock functions	16		

Subject to change without notice.

Safety information

Before the installation and use of the appliance, carefully read the supplied instructions. The manufacturer is not responsible if an incorrect installation and use causes injuries and damage. Always keep the instructions with the appliance for future reference.

Children and vulnerable people safety

- This appliance can be used by children aged from 8 years and above and persons with reduced physical, sensory or mental capabilities or lack of experience and knowledge if they have been given supervision or instruction concerning the use of the appliance in a safe way and understand the hazards involved. Children of less than 8 years of age and persons with very extensive and complex disabilities shall be kept away from the appliance unless continuously supervised.
- Children should be supervised to ensure that they do not play with the appliance.
- Keep all packaging away from children and dispose of it appropriately.

- **WARNING:** The appliance and its accessible parts become hot during use. Keep children and pets away from the appliance when in use and when cooling down.
- If the appliance has a child safety device, it should be activated.
- Children shall not carry out cleaning and user maintenance of the appliance without supervision.

General safety

- This appliance is for cooking purposes only.
- This appliance is designed for single household domestic use in an indoor environment.
- This appliance may be used in offices, hotel guest rooms, bed & breakfast guest rooms, farm guest houses and other similar accommodation where such use does not exceed (average) domestic usage levels.
- Only a qualified person can install this appliance and replace the cable.
- **WARNING:** The appliance and its accessible parts become hot during use. Care should be taken to avoid touching heating elements.
- Always use oven gloves to remove or insert accessories or ovenware.
- Before any maintenance, cut the power supply.
- **WARNING:** Ensure that the appliance is switched off before replacing the lamp to avoid the possibility of electric shock.
- Do not use the appliance before installing it in the built-in structure.
- Do not use a steam cleaner to clean the appliance.
- Do not use harsh abrasive cleaners or sharp metal scrapers to clean the glass door since they can scratch the surface, which may result in shattering of the glass.

- If the mains power supply cable is damaged, it must be replaced by the manufacturer, its Authorised Service Centre or similarly qualified persons to avoid an electrical hazard.
- Before pyrolytic cleaning, remove all accessories and excessive deposits/spills from the appliance cavity.
- To remove the shelf supports first pull the front of the shelf support and then the rear end away from the side walls. Install the shelf supports in the opposite sequence.
- Use only the food sensor recommended for this appliance.

Safety instructions

Installation

 **Warning!** Only a qualified person must install this appliance.

- Remove all the packaging.
- Do not install or use a damaged appliance.
- Follow the installation instructions supplied with the appliance.
- Always take care when moving the appliance as it is heavy. Always use safety gloves and enclosed footwear.
- Do not pull the appliance by the handle.
- Install the appliance in a safe and suitable place that meets installation requirements.
- Keep the minimum distance from other appliances and units.
- Before mounting the appliance, check if the oven door opens without restraint.
- The appliance is equipped with an electric cooling system. It must be operated with the electric power supply.

Electrical connection

 **Warning!** Risk of fire and electric shock.

- All electrical connections should be made by a qualified electrician.
- The appliance must be earthed.
- Make sure that the parameters on the rating plate are compatible with the electrical ratings of the mains power supply.
- Always use a correctly installed shockproof socket.
- Do not use multi-plug adapters and extension cables.
- Make sure not to cause damage to the mains plug and to the mains cable. Should the mains cable need to be replaced, this must be carried out by our Authorised Service Centre.
- Do not let mains cables touch or come near the appliance door or the niche below the appliance, especially when it operates or the door is hot.
- The shock protection of live and insulated parts must be fastened in such a way that it cannot be removed without tools.
- Connect the mains plug to the mains socket only at the end of the installation. Make sure that there is access to the mains plug after the installation.
- If the mains socket is loose, do not connect the mains plug.
- Do not pull the mains cable to disconnect the appliance. Always pull the mains plug.
- Use only correct isolation devices: line protecting cut-outs, fuses (screw type fuses removed from the holder), earth leakage trips and contactors.

- The electrical installation must have an isolation device which lets you disconnect the appliance from the mains at all poles. The isolation device must have a contact opening width of minimum 3 mm.
- Fully close the appliance door before you connect the mains plug to the mains socket.

Use



Warning! Risk of injury, burns and electric shock or explosion.

- Do not change the specification of this appliance.
- Make sure that the ventilation openings are not blocked.
- Do not let the appliance stay unattended during operation.
- Deactivate the appliance after each use.
- Be careful when you open the appliance door while the appliance is in operation. Hot air can be released.
- Do not operate the appliance with wet hands or when it comes in contact with water.
- Do not apply pressure on the open door.
- Do not use the appliance as a work surface or as a storage surface.
- Open the appliance door carefully. The use of ingredients with alcohol can cause a mixture of alcohol and air.
- Do not let sparks or open flames to come in contact with the appliance when you open the door.
- Always use glass and jars approved for preserving purposes.
- Do not put flammable products or items moistened with flammable products in, near or on the appliance.



Warning! Risk of damage to the appliance.

- To prevent damage or discolouration to the enamel:
 - do not put ovenware or other objects directly on the bottom of the appliance's cavity.
 - do not put aluminium foil directly on the bottom of cavity of the appliance.

- do not put water directly into the hot appliance.
- do not keep moist dishes and food in the appliance after you finish the cooking.
- be careful when you remove or install the accessories.

- Discolouration of the enamel or stainless steel has no effect on the performance of the appliance.
- Use a deep pan for moist cakes. Fruit juices cause stains that can be permanent.
- Use only accessories supplied with this appliance or recommended by the manufacturer.
- Always cook with the appliance door closed.
- If the appliance is installed behind a furniture panel (e.g. a door) make sure the door is never closed when the appliance operates. Heat and moisture can build up behind a closed furniture panel and cause subsequent damage to the appliance, the housing unit or the floor. Do not close the furniture panel until the appliance has cooled down completely after use.

Care and Cleaning



Warning! Risk of injury, fire, or damage to the appliance.

- Before maintenance, deactivate the appliance and disconnect the mains plug from the mains socket.
- Make sure the appliance is cold. There is a risk that the glass panels can break.
- Replace door glass panels immediately when they are damaged. Contact the Authorised Service Centre.
- Be careful when you remove the door from the appliance. The door is heavy!
- Clean the appliance regularly to prevent the deterioration of the surface material.
- Fat and food remaining in the appliance can cause fire.
- If you use an oven spray, follow the safety instructions on the packaging.

Pyrolytic cleaning

⚠ Warning! Risk of injury / fires / chemical emissions (fumes) during the pyrolytic mode.

- During pyrolytic cleaning, fumes are released that are not harmful to humans, including infants or persons with medical conditions.
- Unlike all humans, some birds and reptiles can be extremely sensitive to potential fumes emitted during the cleaning process of all pyrolytic ovens. Small pets can also be highly sensitive to the localized temperature changes in the vicinity of all pyrolytic ovens when the pyrolytic self-cleaning program is in operation.
- Before carrying out a pyrolytic self-cleaning function remove from the oven cavity:
 - any excess food residues, oil or grease spills / deposits.
 - any removable objects (including shelves, side rails / telescopic runners, etc. provided with the product) particularly any non-stick pots, pans, trays, utensils etc.
- Non-stick surfaces on pots, pans, trays, utensils, etc., can be damaged by the high temperature pyrolytic cleaning operation of all pyrolytic ovens and can be also a source for low level harmful fumes.
- Read carefully all the instructions for pyrolytic cleaning.
- Keep children away from the appliance while the pyrolytic cleaning is in operation. The appliance becomes very hot and hot air is released from the front cooling vents.
- Pyrolytic cleaning and first maximum temperature use are high temperature operations that can release fumes from cooking residues and construction materials, as such consumers are strongly advised to:
 - Provide good ventilation during and after each pyrolytic cleaning.

- Provide good ventilation during and after the first use at maximum temperature operation.
- Ensure that any pets (especially birds) are taken as far as possible from the vicinity of the appliance location during and after the pyrolytic cleaning and first use maximum temperature operation. Keeping them in a different room would be the preferred option during the pyrolytic cycle and until appliance has cooled down again to room temperature. Good ventilation has to be provided during and after (till appliance cools down) operations of the pyrolytic cycle and first maximum temperature use cycle.

Internal lighting

⚠ Warning! Risk of electric shock.

- Concerning the lamp(s) inside this product and spare part lamps sold separately: These lamps are intended to withstand extreme physical conditions in household appliances, such as temperature, vibration, humidity, or are intended to signal information about the operational status of the appliance. They are not intended to be used in other applications and are not suitable for household room illumination.
- This product contains a light source of energy efficiency class G.
- Use only lamps with the same specifications.

Service

- To repair the appliance contact the Authorised Service Centre.
- Use original spare parts only.

Disposal

⚠ Warning! Risk of injury or suffocation.

- Contact your municipal authority for information on how to discard the appliance correctly.

- Disconnect the appliance from the mains supply.
- Cut off the mains electrical cable close to the appliance and dispose of it.
- Remove the door to prevent children and pets from getting trapped inside the appliance.
- **Packaging material:**

The packaging material is recyclable. Plastic parts are marked with international abbreviations such as PE, PS, etc. Dispose of the packaging material in the containers provided for this purpose at your local waste management facility.

Installation

 **Warning!** Refer to Safety chapters.

Assembly

 Refer to the Assembly Instructions for the installation.

Electrical installation

 **Warning!** Only a qualified person must do the electrical installation.

 The manufacturer is not responsible if you do not follow the safety precautions from the Safety chapters.

This oven is only supplied with a main cable.

Cable

Cable types applicable for installation or replacement:

H07 RN-F, H05 RN-F, H05 RRF, H05 VV-F, H05 V2V2-F (T90), H05 BB-F

For the section of the cable refer to the total power on the rating plate. You can also refer to the table:

Total power (W)	Section of the cable (mm ²)
maximum 1380	3 x 0.75
maximum 2300	3 x 1
maximum 3680	3 x 1.5

The earth cord (green / yellow cable) must be 2 cm longer than the brown phase and blue neutral cables.

Product description

General overview

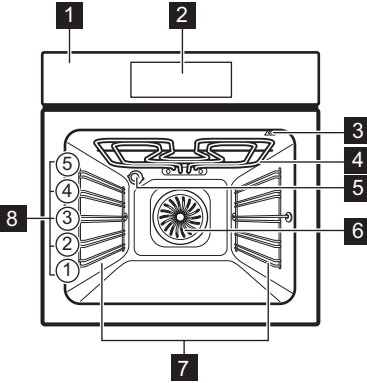

- 1** Control panel
- 2** Display
- 3** Socket for the food sensor
- 4** Heating element

- 5** Lamp
- 6** Fan
- 7** Shelf support, removable
- 8** Shelf positions

Accessories

- **Wire shelf** x 1
For cookware, cake tins, roasts.
- **Baking tray** x 1
For cakes and biscuits.
- **Grill- / Roasting pan** x 1
To bake and roast or as pan to collect fat.
- **AirFry: Wire shelf** x 1
To fry food with less oil or without baking paper.
Maximum load: 5 kg.
- **Food Sensor** x 1
To measure how far the food is cooked.
- **Telescopic runners** x 1 set
For shelves and trays.

Control panel

Control panel overview

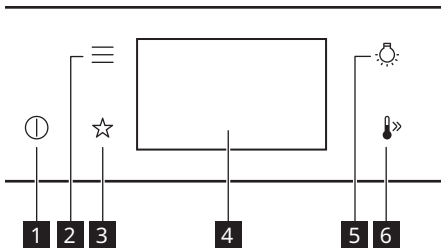

1	ON / OFF Press and hold to turn the appliance on and off.
----------	---

2	Menu Lists the appliance options and setting functions.
3	Favourites Lists the favourite settings.
4	Display Shows the current settings of the appliance.
5	Lamp switch To turn the lamp on and off.
6	Fast Heat Up To turn on and off the function: Fast Heat Up.

Display

Display with key functions set.

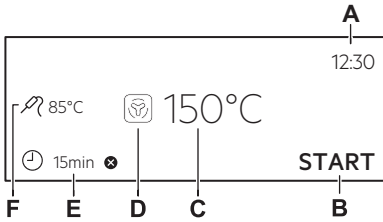

- A. Time of Day
- B. START / STOP
- C. Temperature
- D. Heating functions
- E. Timer
- F. Food Sensor (selected models only)

Display indicators	
	To turn the options on and off.
	The appliance is locked.
	The sound alarm function is activated.
	The sound alarm and stop cooking function is activated.
	Pop up message only is activated.
	Delayed start function is activated.
	To cancel the setting.

Display indicators	
OK	To confirm the selection / setting.
<	To go one level back in the menu.
↶	To undo the last action.

The display shows various messages. When a message window appears, press the display to continue.

Before first use

Warning! Refer to Safety chapters.

First connection

The display shows welcome message after the first connection.

You have to set: Language, Display Brightness, Key Tones, Buzzer Volume, Time of Day.

Initial preheating and cleaning

Preheat the empty appliance before the first use and contact with food. The appliance can emit unpleasant smell and smoke. Ventilate the room during preheating.

1. Remove all accessories and removable shelf supports from the appliance.
2. Set the function . Set the maximum temperature. Refer to Daily use. Let the appliance operate for 1 h.

3. Set the function . Set the maximum temperature. Let the appliance operate for 15 min.
4. Set the function . Set the maximum temperature. Let the appliance operate for 15 min.
5. Turn off the appliance and wait until it is cold.
6. Clean the appliance and the accessories only with a microfibre cloth, warm water and a mild detergent.
7. Put the accessories and removable shelf supports back to their initial position.

Mechanical child lock

The oven has the mechanical child lock installed. It is the door lock on the right side of the oven, below the control panel.

To open the oven door with the child lock:

1. Push and hold up the child lock.
2. Pull the door handle to open the door.
Close the oven door without pushing the child lock.

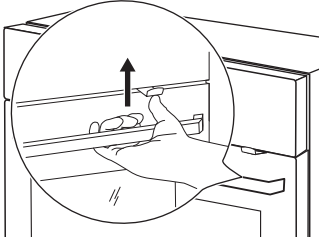

To remove the child lock:

1. Open the door and remove the child lock with the torx key supplied with the oven.
2. Fix the screw back after removing the child lock.

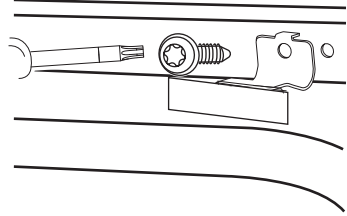

Daily use

Warning! Refer to Safety chapters.

Heating functions







STANDARD

	Grill To grill thin pieces of food and to toast bread.
	Turbo Grilling To roast large meat joints or poultry with bones on one shelf position. To bake gratins and to brown.
	True Fan Cooking To roast meat and bake cakes. Set a lower temperature than for Conventional Cooking as the fan distributes heat evenly in the oven interior.
	Frozen Foods Perfect for ready meals (e.g. french fries, croquettes or spring rolls).

	Conventional Cooking To bake and roast food on one shelf position.
	Pizza Function To bake pizza and other dishes that require more heat from below.
	AirFry Frying food with less oil and without baking paper
	Bottom Heat Choose this function after a cooking process to brown the food more on the bottom if needed. Use the lowest shelf level.
	Bread Baking To bake bread.
	Dough Proving To speed up the rising of the yeast dough. Cover the surface of the dough to prevent from drying.

 The lamp may turn off automatically at a temperature below 80°C during some heating functions.

SPECIALS

	<p>Preserving To preserve vegetables and fruits, place canning jars in a baking tray filled with water, using heat-resistant jars with bayonet or screw caps of the same size. Use the lowest shelf position.</p>
	<p>Dehydrating To dry sliced fruit, vegetables and mushrooms. To allow the moisture-saturated air to escape and the fruit to dry better, it is advisable to open the oven door occasionally during the drying process.</p>
	<p>Plate Warming To preheat plates for serving.</p>
	<p>Defrost To defrost food (vegetables and fruit). The defrosting time depends on the amount and size of the frozen food.</p>
	<p>Au Gratin For dishes such as lasagna or potato gratin. To bake gratins and to brown.</p>
	<p>Slow Cooking Low temperature cooking process. It's perfect to cook delicate food (e.g., beef, veal or lamb).</p>
	<p>Keep Warm To keep food warm. Please note that some dishes may continue to cook and dry out while being kept warm. Cover the dishes if necessary.</p>

	<p>Moist Fan Baking This function is designed to save energy during cooking. When you use this function, the temperature inside the appliance may differ from the set temperature. The residual heat is used. The heating power may be reduced. For more information refer to Daily use, Notes on: Moist Fan Baking.</p>
---	---

Notes on: Moist Fan Baking

This function was used to comply with the energy efficiency class and ecodesign requirements (according to EU 65/2014 and EU 66/2014). Tests according to: IEC/EN 60350-1.

The oven door should be closed during cooking so that the function is not interrupted and the oven operates with the highest energy efficiency possible.

When you use this function the lamp automatically turns off after 30 sec.

For the cooking instructions refer to Hints and tips, Moist Fan Baking.

Setting: Heating functions

1. Turn on the appliance. The display shows the default heating function and the temperature.
2. Press the symbol of the heating function  to enter the submenu.
3. Select the heating function and press OK.
4. Set the temperature. Press OK.
5. Press START .
Food Sensor - you can plug the sensor at any time before or during cooking. Refer to Using the accessories, Food sensor.
6. STOP - press to turn off the heating function.
7. Turn off the appliance.

Menu

Press  to enter the menu.

Menu item		Description
Assisted Cooking		Lists automatic programmes.
Cleaning		Lists cleaning programmes.
Favourites		Lists the favourite settings.
Options		To set the appliance configuration.
Settings	Setup	To set the appliance configuration.
	Service	Shows the software version and configuration.

Submenu for: Cleaning

Submenu	Description
Pyrolytic cleaning, quick	Duration: 1 h.
Pyrolytic cleaning, normal	Duration: 1 h 30 min.
Pyrolytic cleaning, intense	Duration: 2 h 30 min.

Submenu for: Options

Submenu	Description
Light	Turns the lamp on and off.
Child Lock	Prevents accidental activation of the appliance.
Fast Heat Up	Shortens the heat up time. It is available only for some of the heating functions.

Submenu	Description
Cleaning Reminder	Turns the reminder on and off.
Digital Clock Style	Changes the format of the displayed time indication.

Submenu for: Settings

Setup

Submenu	Description
Language	Sets the appliance language.
Display Brightness	Sets the display brightness.
Key Tones	Turns the tone of the touch fields on and off. It is not possible to mute the tone for  .
Buzzer Volume	Sets the volume of key tones and signals.
Time of Day	Sets the current time and date.

Service

Submenu	Description
Software Version	Information about software version.
Reset All Settings	Restores factory settings.

Setting: Assisted Cooking



Assisted Cooking submenu consists of a set of additional functions and programs that are designed for dedicated dishes. Each dish in this submenu is provided with a suitable setting. You can adjust the time and the temperature during cooking.

For some of the dishes you can also cook with Food Sensor. The degree to which a dish is cooked:

- Rare

- Medium
- Well Done

For some of the dishes you can also cook with Weight Automatic.

1. Turn on the appliance.
2. Press .
3. Press . Enter Assisted Cooking.



4. Choose a dish or a food type.
5. Place the food inside the appliance and press START .

When the function ends, check if the food is ready. Extend the cooking time, if needed.

Additional functions



Favourites ☆



You can save up to 3 of your favourite settings, such as heating function and cooking time.

1. Turn on the appliance.
 2. Select the preferred setting.
 3. Press .
 4. Select: Favourites / Save current settings.
 5. Press + to add the setting to the list of: Favourites.
 6. Press OK.
-  - press to reset the setting.
-  - press to cancel the setting.

Function lock

This function prevents an accidental change of the appliance function.

1. Turn on the appliance.
2. Set a heating function.
3. ,  - press at the same time to turn on the function.

,  - press at the same time to turn off the function.

Child Lock

This function prevents accidental activation of the appliance.

1. Turn on the appliance.
2. Press .
3. Select Options / Child Lock.
4. Press the code letters in an alphabetical order.

5. Turn off the appliance.

Child Lock is activated.



Access to: Timer and lamp is available. The door is locked when the appliance is turned off.

To enable the use of the appliance, press the code letters in an alphabetical order.

To deactivate this function repeat the above steps.

Automatic switch-off

For safety reasons, if the heating function is active and no settings are changed, the appliance will turn off automatically after a certain period of time.

 (°C)	 (h)
30 - 115	12.5
120 - 195	8.5
200 - 245	5.5
250 - maximum	3

If you intend to run a heating function for a duration exceeding the automatic switch-off time, set the cooking time. Refer to Clock functions.

The Automatic switch-off does not work with the functions: Light, Food Sensor, End time.

Cooling fan

When the appliance operates, the cooling fan turns on automatically to keep the surfaces of the appliance cool. If you turn off

the appliance, the cooling fan can continue to operate until the appliance cools down.

Clock functions

Clock functions description

Function	Description
Timer	To set the length of cooking. Maximum is 23 h 59 min. You can set what happens when the time is up by setting the preferred: End Action.
End Action	Sound Alarm - when the time is up the signal sounds. You can set this function at any time, even when the appliance is turned off.
	Sound Alarm and stop cooking - when the time is up the signal sounds and the heating function turns off.
	Pop up message only - when the time is up the message appears on the display. You can set this function at any time, even when the appliance is turned off.
Delayed start	To postpone the start and / or end of cooking.
Time Extension	To extend the cooking time.
Uptimer	To show how long the appliance operates. Maximum is 23 h 59 min. You can turn the function on and off. This function has no effect on the operation of the appliance.

Setting: Time of Day

1. Turn on the appliance.
2. Press: Time of Day.
3. Set the time.
4. Press **OK**.



Setting: Timer

1. Choose the heating function and set the temperature.
2. Press .
3. Set the time.
You can select the preferred End action by pressing ● ● ● .
4. Press **OK**. Repeat the action until the display shows the main screen.
When 10% of cooking time is left and the food does not seem to be ready, you can extend cooking time. You can also change the heating function. Press **+1min** to extend the cooking time.

Setting: Delayed start

1. Set the heating function and the temperature.
2. Press .
3. Set the cooking time.
4. Press ● ● ● .
5. Press: Delayed start.
6. Choose the desired start time.
7. Press **OK**. Repeat the action until the display shows the main screen.

Setting: Uptimer

1. Press .
2. Press ● ● ● .
3. Press: Uptimer.
4. Slide or press  to show the running time on the main screen.
5. Press **OK**. Repeat the action until the display shows the main screen.

Changing timer settings

You can change the set time during cooking at any time.

1. Press .

2. Set the timer value.

3. Press OK.

Using the accessories

⚠ Warning! Refer to Safety chapters.

Inserting accessories

A small indentation at the top increases safety and provides tilt protection. The indentations are also anti-tip devices. The rim around the shelf prevents cookware from slipping off the shelf.

Wire shelf

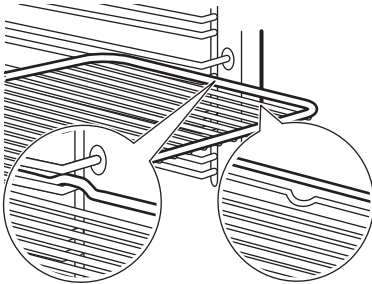

Insert the shelf between the guide bars of the shelf support and make sure that the feet point down. Make sure that the shelf touches the back of the oven interior.

Baking tray / Deep pan

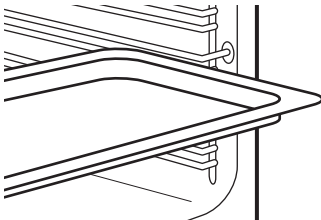

Push the tray between the guide bars of the shelf support. Place the baking tray with the slope towards the back of the oven interior.

AirFry: Wire shelf

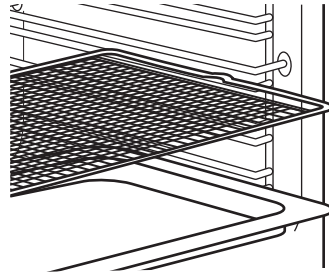

Place the AirFry wire shelf on the third shelf position. Place the baking tray underneath.

Do not use the AirFry wire shelf with the telescopic runners as the oil could make their surface slippery and reduce the wire shelf stability.

Food Sensor

It measures the temperature inside the food. You can use it with every heating function.

There are two temperatures to be set:

- °C - the temperature inside the appliance. It should be at least 25°C higher than the food core temperature.
-  - the food core temperature.

Recommendations:

- Ingredients should be at room temperature.
- Do not use it for liquid dishes.
- During cooking the needle of the food sensor must be fully inserted in the dish.

The appliance calculates an approximate end of cooking time. It depends on the quantity of food, the heating function and the temperature.

Cooking with: Food Sensor

⚠ Warning! There is a risk of burns as Food Sensor and shelf supports become hot. Do not touch Food Sensor handle with bare hands. Always use oven gloves.

1. Turn on the appliance.
2. Set a heating function or a dish and, if necessary, the oven temperature.
3. Insert Food Sensor inside the dish:

Meat, poultry and fish

Insert the entire needle of the Food Sensor into the meat or fish at its thickest part.

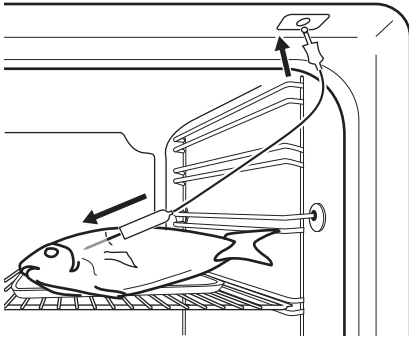

Casserole

Insert the tip of Food Sensor exactly in the centre of the casserole. Food Sensor should be stabilized in one place during cooking. Use a solid ingredient to achieve that. Use the rim of the baking dish to support the silicone handle of Food Sensor. The tip of Food Sensor should not touch the bottom of a baking dish.

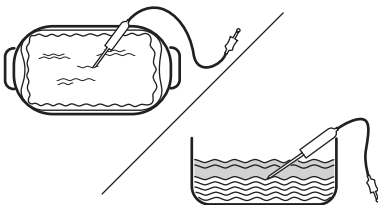

4. Plug Food Sensor into the socket located inside the appliance. Refer to Product description.

The display shows the current temperature of Food Sensor.

5. **↻** - press to set the core temperature of the sensor.
6. ●●● - press to set the preferred option:
 - Sound Alarm - when food reaches the core temperature, the signal sounds.
 - Sound Alarm and stop cooking - when food reaches the core temperature, the signal sounds and the cooking stops.
7. Select the option and repeatedly press **OK** to go to main screen.
8. Press **START**.
9. When the food reaches the set temperature, the signal sounds. Check if the food is ready. Extend the cooking time, if needed.
10. Remove Food Sensor plug from the socket and remove the dish from the appliance.

Using: Telescopic runners

i Keep the installation instructions for the telescopic runners for future use.

With telescopic runners you can put in and remove wire shelves and trays easily.

⚠ Caution! Do not clean the telescopic runners in the dishwasher. Do not lubricate the telescopic runners.

1. Pull out the right and left hand telescopic runners.

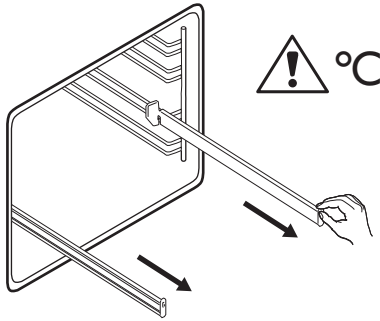

- Put the wire shelf on the telescopic runners and carefully push them into the oven. Make sure you push back the

telescopic runners fully in the oven before you close the oven door.

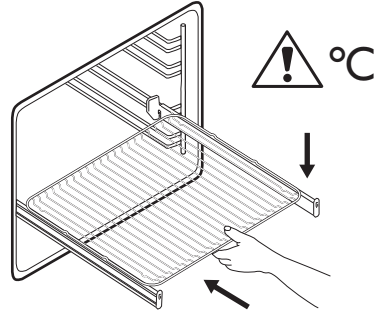

Hints and tips

Cooking recommendations

The temperature and cooking times in the tables are for guidance only. They depend on the recipes, quality and quantity of the ingredients used.

Your appliance may bake or roast differently than your previous appliance. The hints below show recommended settings for temperature, cooking time and shelf position for specific types of food.

Count the shelf positions from the bottom of the oven floor.

If you cannot find the settings for a specific recipe, look for a similar one.

For energy saving tips refer to Energy efficiency.

Symbols used in the tables:

	Food type
	Heating function
	Temperature

	Accessory
	Shelf position
	Cooking time (min)





Moist Fan Baking - recommended accessories





Use dark and non-reflective tins and containers. They have better heat absorption than light colour and reflective dishes.

- **Pizza pan** - dark, non-reflective, diameter 28 cm
- **Baking dish** - dark, non-reflective, diameter 26 cm
- **Ramekins** - ceramic, diameter 8 cm, height 5 cm
- **Flan base tin** - dark, non-reflective, diameter 28 cm

Moist Fan Baking





For the best results follow suggestions listed in the table below.





		°C		
Sweet rolls, 16 pieces	baking tray or dripping pan	180	2	20 - 30
Rolls, 9 pieces	baking tray or dripping pan	180	2	30 - 40
Pizza, frozen, 0.35 kg	wire shelf	220	2	10 - 15
Swiss Roll	baking tray or dripping pan	170	2	25 - 35
Brownie	baking tray or dripping pan	175	3	25 - 30
Soufflè, 6 pieces	ceramic ramekins on wire shelf	200	3	25 - 30
Sponge flan base	flan base tin on wire shelf	180	2	15 - 25
Victoria sandwich	baking dish on wire shelf	170	2	40 - 50
Poached fish, 0.3 kg	baking tray or dripping pan	180	3	20 - 25
Whole fish, 0.2 kg	baking tray or dripping pan	180	3	25 - 35
Fish fillet, 0.3 kg	pizza pan on wire shelf	180	3	25 - 30
Poached meat, 0.25 kg	baking tray or dripping pan	200	3	35 - 45
Shashlik, 0.5 kg	baking tray or dripping pan	200	3	25 - 30
Cookies, 16 pieces	baking tray or dripping pan	180	2	20 - 30
Macaroons, 24 pieces	baking tray or dripping pan	180	2	25 - 35
Muffins, 12 pieces	baking tray or dripping pan	170	2	30 - 40
Savory pastry, 20 pieces	baking tray or dripping pan	180	2	25 - 30
Short crust biscuits, 20 pieces	baking tray or dripping pan	150	2	25 - 35

		°C		
Tartlets, 8 pieces	baking tray or dripping pan	170	2	20 - 30
Vegetables, poached, 0.4 kg	baking tray or dripping pan	180	3	35 - 45
Vegetarian omelette	pizza pan on wire shelf	200	3	25 - 30
Mediterranean vegetables, 0.7 kg	baking tray or dripping pan	180	4	25 - 30

Information for test institutes

Tests according to IEC 60350-1.

				°C	
Small cakes, 20 per tray	Conventional Cooking	Baking tray	3	170	20 - 35
Small cakes, 20 per tray	True Fan Cooking	Baking tray	3	150 - 160	20 - 35
Small cakes, 20 per tray	True Fan Cooking	Baking tray	2 and 4	150 - 160	20 - 35
Apple pie, 2 tins Ø20 cm	Conventional Cooking	Wire shelf	2	180	70 - 90
Apple pie, 2 tins Ø20 cm	True Fan Cooking	Wire shelf	2	160	70 - 90
Fatless sponge cake, cake mould Ø26 cm ¹⁾	Conventional Cooking	Wire shelf	2	170	40 - 50
Fatless sponge cake, cake mould Ø26 cm ¹⁾	True Fan Cooking	Wire shelf	2	160	40 - 50
Fatless sponge cake, cake mould Ø26 cm ¹⁾	True Fan Cooking	Wire shelf	2 and 4	160	40 - 60
Shortbread	True Fan Cooking	Baking tray	3	140 - 150	20 - 40
Shortbread	True Fan Cooking	Baking tray	2 and 4	140 - 150	25 - 45
Shortbread	Conventional Cooking	Baking tray	3	140 - 150	25 - 45

				°C	
Toast ¹⁾	Grill	Wire shelf	4	max.	1 - 5

1) Preheat the appliance for 10 minutes.

Care and cleaning

 **Warning!** Refer to Safety chapters.

Notes on cleaning

Cleaning agents

- Clean the front of the appliance only with a microfibre cloth with warm water and a mild detergent.
- Use a cleaning solution to clean metal surfaces.
- Clean stains with a mild detergent.

Everyday use

- Clean the interior of the appliance after each use. Fat accumulation or other residue may cause fire.
- Moisture can condense in the appliance or on the door glass panels. To decrease the condensation, let the appliance work for 10 minutes before cooking. Do not store food in the appliance for longer than 20 minutes. Dry the interior of the appliance only with a microfibre cloth after each use.

Accessories

- Clean all accessories after each use and let them dry. Use only a microfibre cloth with warm water and a mild detergent. Do not clean the accessories in a dishwasher.
- Do not clean the non-stick accessories using abrasive cleaner or sharp-edged objects.

Removing the shelf supports

Remove the shelf supports to clean the appliance.

1. Turn off the appliance and wait until it is cold.

2. Pull the front of the shelf support away from the side wall.
3. Pull the rear end of the shelf support away from the side wall and remove it.

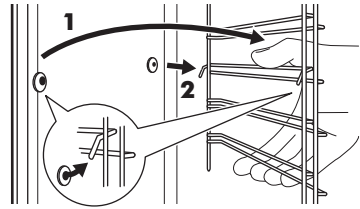



4. Put the shelf supports back to the initial position. Repeat the steps in the reverse order.

If the telescopic runners are supplied, its retaining pins must point to the front.

Pyrolytic Cleaning

Use it to clean the appliance and burn off the residues.

 **Warning!** There is a risk of burns.

 **Caution!** If there are other appliances installed in the same cabinet, do not use them at the same time as this function. It can cause damage to the oven.

Do not start the function if you did not fully close the oven door.

1. Make sure the appliance is cold.
2. Remove all accessories.
3. Clean the oven interior and the inner door glass with warm water, a soft cloth and a mild detergent.
4. Turn on the appliance.
5. Press  / Cleaning.
6. Select the cleaning mode.

When the cleaning starts, the oven door is locked and the lamp is off. The cooling fan works at a higher speed.

STOP - press to stop the cleaning before it is completed.

Do not use the appliance until the door lock symbol disappears from the display.

7. When the cleaning ends, turn off the appliance and wait until it is cold.
8. Clean the oven interior with a soft cloth. Remove the residue from the bottom of the oven.

Cleaning Reminder

When the reminder appears, cleaning is recommended.

Use the function: Pyrolytic Cleaning.

Removing and installing door

The oven door has three glass panels. You can remove the oven door and the internal glass panels to clean them. Read the whole "Removing and installing door" instruction before you remove the glass panels.



Caution! Do not use the appliance without the glass panels.

1. Open the door fully and hold both hinges.

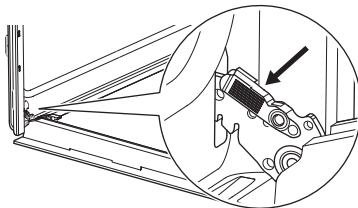

2. Lift and pull the latches until they click.

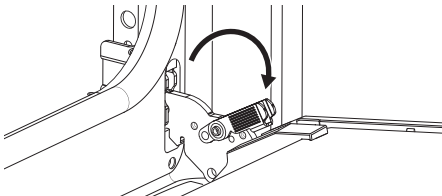

3. Close the oven door halfway to the first opening position. Then lift and pull to remove the door from its seat.

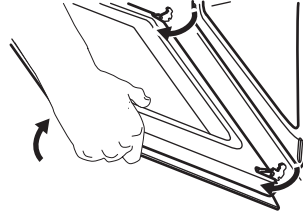

4. Put the door on a soft cloth on a stable surface.
5. Hold the door trim **B** on the top edge of the door at the two sides and push inwards to release the clip seal.

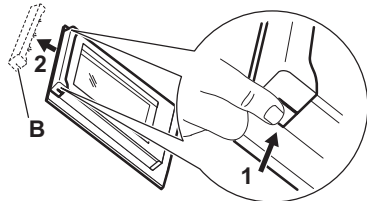

6. Pull the door trim to the front to remove it.
7. Hold the door glass panels by their top edge and carefully pull them out one by one. Start from the top panel. Make sure the glass slides out of the supports completely.

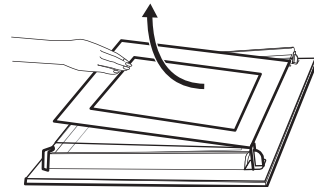

8. Clean the glass panels with water and soap. Dry the glass panels carefully. Do not clean the glass panels in the dishwasher.
9. After cleaning, install the glass panels, the door trim and the oven door, close the latches on the both hinges.

If the door is installed correctly, you will hear a click when closing the latches.

Make sure that you put the glass panels (A and B) back in the correct sequence. Check for the symbol / printing on the side of the glass panel. Each of the glass panels looks different to make the disassembly and assembly easier.

The screen-printing zone must face the inner side of the door. Make sure that after the installation the surface of the glass panel frame on the screen-printing zones is not rough when you touch it.

When installed correctly, the door trim clicks.

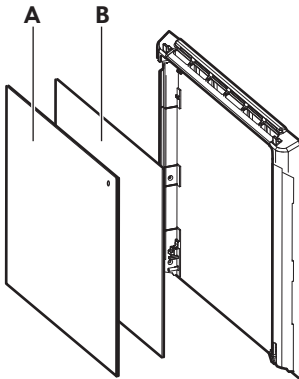

Make sure that you install the middle glass panel in the seats correctly.

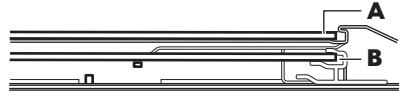

Replacing the lamp

Warning! Risk of electric shock. The lamp can be hot.

- 1. Turn off the appliance and wait until it is cold.
- 2. Disconnect the appliance from the mains.
- 3. Place the cloth on the oven floor.

Caution! Always hold the halogen lamp with a cloth to prevent grease residue from burning on the lamp.

Back lamp

- 1. Turn the glass cover to remove it.
- 2. Clean the glass cover.
- 3. Replace the lamp with a suitable 300°C heat-resistant lamp.
- 4. Install the glass cover.

Troubleshooting

Warning! Refer to Safety chapters.

What to do if...

Problem description	Cause and remedy
You cannot activate or operate the appliance.	The appliance is not connected to an electrical supply or it is connected incorrectly.

Problem description	Cause and remedy
The appliance does not heat up.	The clock is not set. To set the clock refer to Clock functions.
	The door is not closed correctly.
	The fuse is blown. Make sure the fuse is the cause of the problem. If the problem recurs, contact a qualified electrician.
	Child Lock is activated.
The lamp is turned off.	The lamp is burnt out. Replace the lamp. For details refer to Care and cleaning.
 Power cut always stops cleaning. Repeat cleaning if it's interrupted by power failure.	

Error codes

When the software error occurs, the display shows error message. You will find the list of problems in the table below. When the following error message continues to appear on the display, it means a faulty subsystem may have been disabled. In such a case contact your dealer or an Authorized Service Centre.

Code and description	Remedy
F102 - the door is not fully closed or the door lock is broken.	Close the door. Turn the appliance off and on.
F111 - Food Sensor is not correctly inserted into the socket.	Fully plug Food Sensor into the socket.
F240, F439 - the touch fields on the display do not work properly.	Clean the surface of the display. Make sure there is no dirt on the touch fields.
F908 - the appliance system cannot connect with the control panel.	Turn the appliance off and on.

Service data

If you cannot find a solution to the problem yourself, contact an Authorised Service Centre.

The necessary data for the service centre is on the rating plate. The rating plate is located on the front frame of the appliance. It is visible when you open the door. Do not remove the rating plate from the appliance.

We recommend that you write the data here:

Model (MOD.) :	
Product number (PNC):	
Serial number (S.N.):	

Technical data

Technical data

Dimensions (internal)	Width Height Depth	480 mm 361 mm 416 mm
Area of baking tray	1438 cm ²	
Top heating element	2300 W	
Bottom heating element	1000 W	
Grill	2300 W	
Ring	2400 W	
Total rating	3490 W	
Voltage	220 - 240 V	
Frequency	50 - 60 Hz	
Number of functions	18	

Energy efficiency

Product information sheet and product information according to EU energy labelling and ecodesign regulations

Supplier's name	IKEA
Model identification	STENABY 406.139.55 STENABY 806.139.58 FRILLESBO 506.141.10
Energy efficiency index	81.2
Energy efficiency class	A+
Energy consumption with a standard load, conventional mode	0.93 kWh/cycle
Energy consumption with a standard load, fan-forced mode	0.69 kWh/cycle
Number of cavities	1
Heat source	Electricity

Volume	72 l	
Type of oven	Built-in oven	
Mass	STENABY 406.139.55	33.2 kg
	STENABY 806.139.58	34.0 kg
	FRILLESBO 506.141.10	33.0 kg

Product information for power consumption and maximum time to reach applicable low power mode

Power consumption

Power consumption in standby	0.8 W
Maximum time needed for the equipment to automatically reach the applicable low power mode	20 min

Energy saving tips

Following tips below will help you save energy when using your appliance.

Make sure that the appliance door is closed when the appliance operates. Do not open the appliance door too often during cooking. Keep the door gasket clean and make sure it is well fixed in its position.

Use metal cookware and dark, non-reflective tins and containers to improve energy saving.

Do not preheat the appliance before cooking unless specifically recommended.

Keep breaks between baking as short as possible when you prepare a few dishes at one time.

Cooking with fan

When possible, use the cooking functions with fan to save energy.

Residual heat

When the cooking duration is longer than 30 min, reduce the appliance temperature to minimum 3 - 10 min before the end of

cooking. The residual heat inside the appliance will continue to cook.

Use the residual heat to keep the food warm or warm up other dishes.

When you turn off the appliance, the display shows the residual heat or temperature.

If a programme with Duration is activated and the cooking time is longer than 30 min, the heating elements automatically turn off earlier in some appliance functions.

Keep food warm

Choose the lowest possible temperature setting to use residual heat and keep the food warm. The residual heat indicator or temperature appears on the display.

Cooking with the lamp off

Turn off the lamp during cooking. Turn it on only when you need it.

Moist Fan Baking

Function designed to save energy during cooking.

When you use this function the lamp automatically turns off after 30 sec. You may turn on the lamp again but this action will reduce the expected energy savings.

Environmental concerns

Recycle materials with the symbol . Put the packaging in relevant containers to recycle it. Help protect the environment and human health by recycling waste of electrical and electronic appliances. Do not dispose of

appliances marked with the symbol  with the household waste. Return the product to your local recycling facility or contact your municipal office.

IKEA guarantee

How long is the IKEA guarantee valid?

This guarantee is valid for 5 years from the original date of purchase of your appliance at IKEA, IKEA Pty Ltd, ABN 84006270757 or IKEA NEW ZEALAND LIMITED, NZBN 9429047515468. The original sales receipt is required as proof of purchase. If service work is carried out under guarantee, this will not extend the guarantee period for the appliance.

Who will execute the service?

If you encounter any trouble with the appliance and wish to register a service call or make a claim, please contact your local IKEA customer support centre. The centre will provide service through its own operations or authorized service partner network.

The principal address and contact details in Australia and New Zealand:

IKEA Pty Ltd for Australia and IKEA New Zealand Limited for New Zealand
IKEA Service Office L1 Clock Tower, 630 Princes Highway Tempe, NSW 2044

Contact IKEA customer support centre at www.IKEA.com

Australia: (02) 9010 0264
New Zealand: Refer Contact Us Section on New Zealand Website

What does this guarantee cover?

The guarantee covers faults of the appliance, which have been caused by faulty construction or material faults from the date of purchase from IKEA. This guarantee applies to domestic use only. The products have been designed and tested for domestic purposes only and this guarantee does not cover damage arising from use of the Product in a commercial environment.

The exceptions are specified under the headline "What is not covered under this guarantee?" Within the guarantee period, the costs to remedy the fault e.g. repairs, parts, labour and travel will be covered, provided that the appliance is accessible for repair without special expenditure. Replaced parts become the property of IKEA.

The guarantee exists only if the appliance complies and is installed in accordance with:

- The technical specifications.
- The Assembly Instructions and user manual Safety Information.

IKEA's guarantee is subject to:

- Australian Consumer Law see Schedule 2 to Competition and Consumer Act, 2010.
- New Zealand Consumer Guarantees Act 1993.

This guarantee is in addition to any non-excludable statutory warranties in Australia and New Zealand.

What will IKEA do to correct the problem?

IKEA appointed service provider will examine the product and decide, at its sole discretion, if it is covered under this guarantee. They

will notify you as to whether your claim is covered under this guarantee. If your claim is approved, the IKEA service provider or its authorized service partner, will then, at its sole discretion, either repair the defective product or replace it with the same or a comparable product.

What is not covered under this guarantee?

- Normal wear and tear.
- Deliberate or negligent damage, damage caused by failure to observe operating instructions, incorrect installation or by connection to the wrong voltage, damage caused by chemical or electro-chemical reaction, rust, corrosion or water damage including but not limited to damage caused by excessive lime in the water supply, damage caused by abnormal environmental conditions.
- Consumable parts including batteries and lamps.
- Non-functional and decorative parts which do not affect normal use of the appliance, including any scratches and possible colour differences.
- Accidental damage caused by foreign objects including insect or vermin infestation or substances and cleaning or unblocking of filters, drainage systems or soap drawers.
- Damage to the following parts: ceramic glass, accessories, crockery and cutlery baskets, feed and drainage pipes, seals, lamps and lamp covers, screens, knobs, casings and parts of casings. Unless such damages can be proved to have been caused by production faults.
- Cases where no fault could be found during a technician's visit.
- Repairs not carried out by our appointed service providers and/or an authorized service contractual partner or where non-original parts have been used.
- Repairs caused by installation which is faulty or not according to specification.
- The use of the appliance in a non-domestic environment i.e. professional use.
- Transportation damages. If a customer transports the product to their home or other address, IKEA is not liable for any damage that may occur during transport. However, if IKEA delivers the product to the customer's delivery address, then damage to the product that occurs during this delivery will be covered by this guarantee.
- Cost for carrying out the initial installation of the IKEA appliance. However, if an IKEA service provider or its authorized service partner repairs or replaces the appliance under the terms of this guarantee, the service provider or its authorized service partner will re-install the repaired appliance or install the replacement, if necessary.
- The appliance's serial number or warranty seal has been removed or defaced.

How country law applies

Our goods come with guarantees that cannot be excluded under the Consumer Law in Australia and New Zealand. You are entitled to a replacement or refund for a major failure and compensation for any other reasonably foreseeable loss or damage. You are also entitled to have the goods repaired or replaced if the goods fail to be of acceptable quality and the failure does not amount to a major failure.

This guarantee is not intended in any way to limit or exclude such rights and remedies that you may have under law.

You can find out more information on the websites:

- Australia: www.accc.gov.au
- New Zealand: <https://comcom.govt.nz/>

<https://www.consumerprotection.govt.nz/general-help/consumer-laws/consumer-quarantees-act>

Area of validity

The IKEA guarantee gives you specific legal rights, which cover or exceed all the local legal demands. However these conditions do not limit in any way consumer rights described in the local legislation.

What you must do to make a claim under the guarantee:

To make a claim under the guarantee contact IKEA customer support centre.



- i** Please describe the problem that you are facing with the appliance in detail along with your product article number (8 digit code), the Serial Number (8 digit code that can be found on the rating plate) and date of purchase at the time of call registration.

- i** **SAVE THE SALES RECEIPT!** Kindly keep all these details and original invoice of purchase handy during the service technician's visit to enable him to carry out the job. It is your proof of purchase and required for the guarantee to apply. Note that the receipt reports also the IKEA article name and number (8 digit code) for each of the appliances you have purchased.



701131544-A-452025

