

MATÄLSKARE MATTRADITION

AU

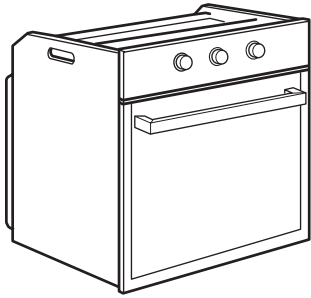

Design and Quality
IKEA of Sweden



1x

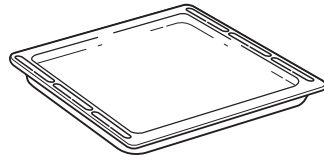

1x

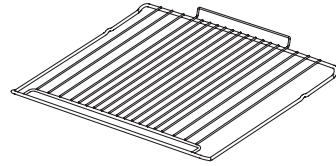

1x

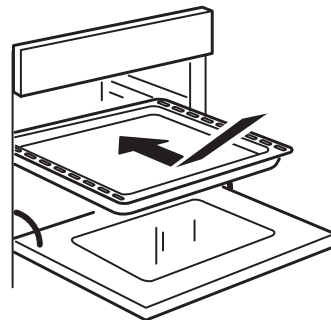
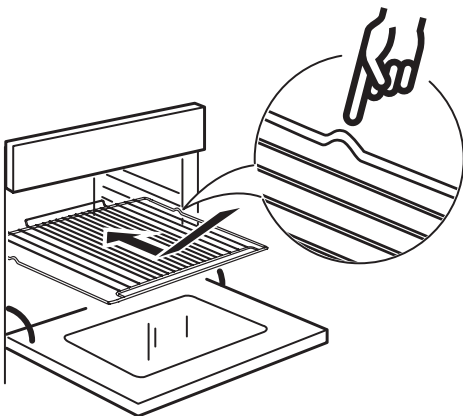
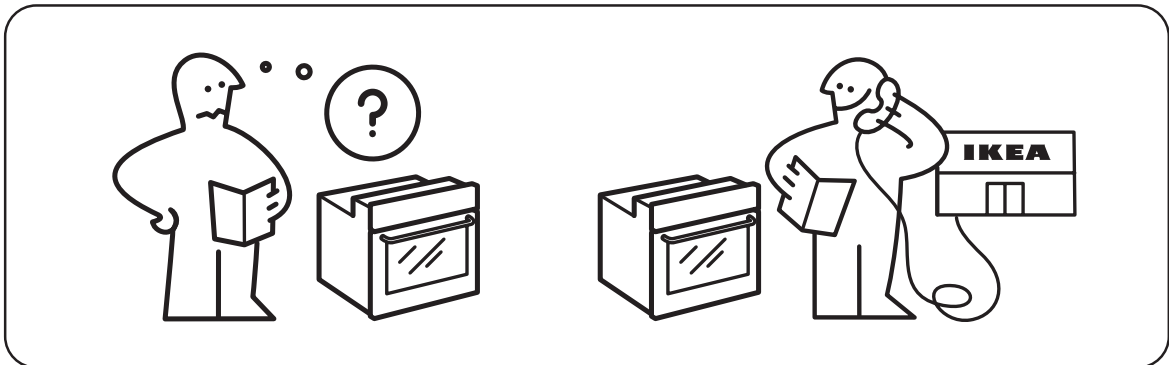

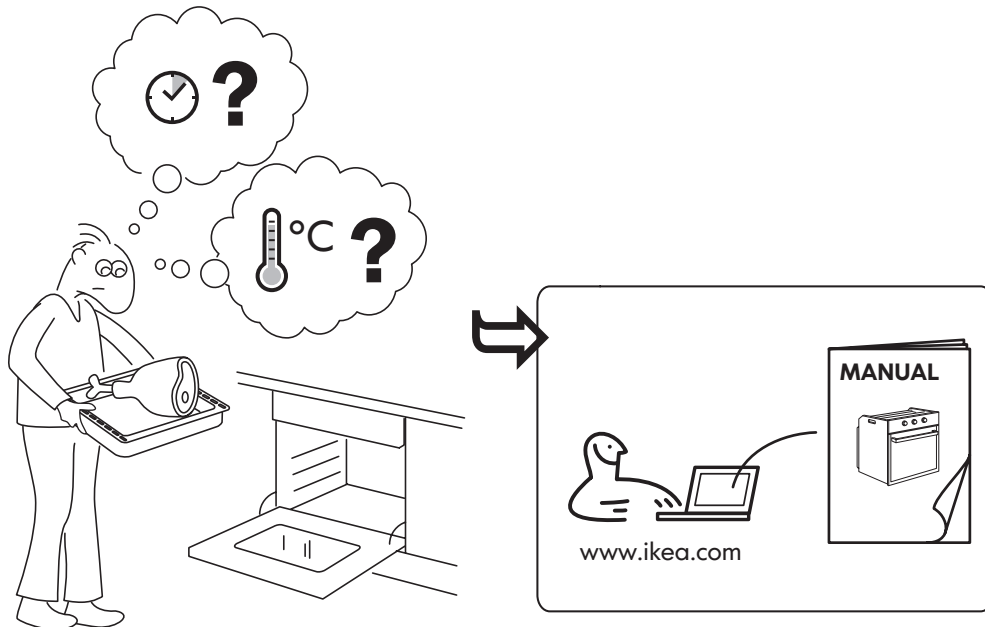
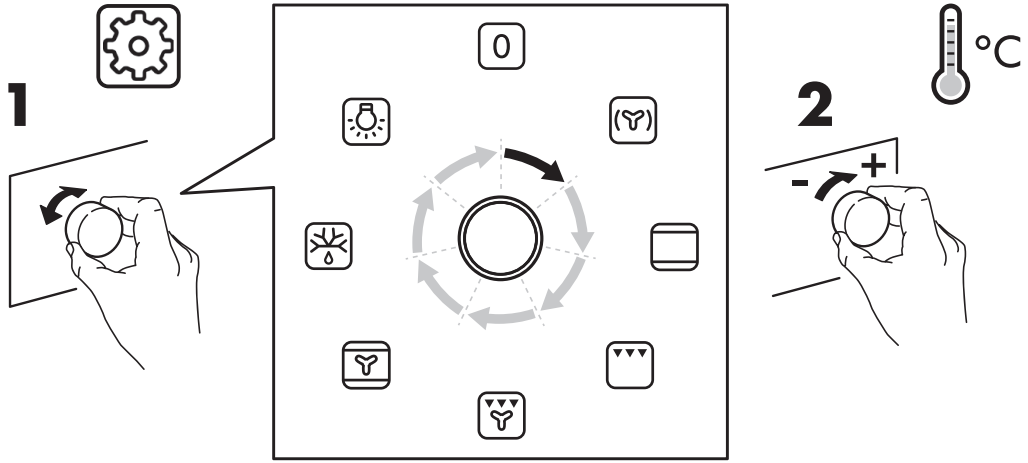

Product description

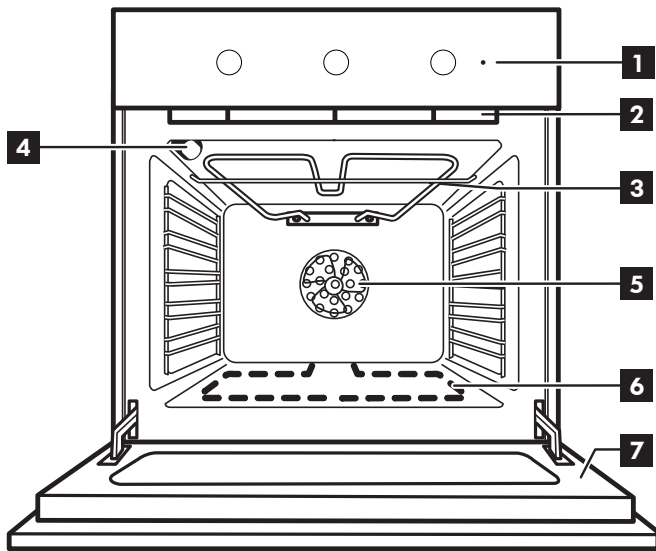

- 1** Control panel
- 2** Cooling fan (not visible)
- 3** Grill element
- 4** Oven lamp
- 5** Oven fan
- 6** Lower heating element (hidden)
- 7** Oven door

Inserting the wire shelf and other accessories

Insert the wire shelf onto the level you require by holding it tilted slightly upwards and resting the raised rear side (pointing upwards) down first. Next, slide it horizontally along the shelf guide as far as possible.

The other accessories, such as the baking tray, are inserted horizontally by sliding them along the shelf guides.



If you want to buy an accessory, call the Authorized Service Centre.

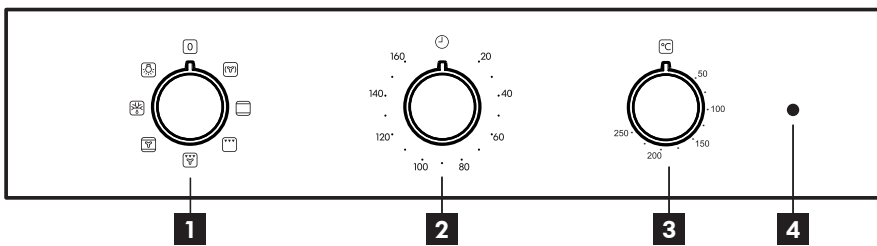



Control panel



- 1** Selection knob
- 2** Time knob
- 3** Thermostat knob
- 4** Led thermostat/preheating

Display / Function

-  **FORCED AIR**
For cooking different foods that require the same cooking temperature on several shelves (maximum three) at the same time.
-  **CONVENTIONAL (Top and Bottom Heat)**
For cooking any kind of dish on one shelf only.
-  **GRILL**
For grilling steaks, kebabs and sausages, cooking vegetables au gratin or toasting bread.

-  **GRILLING WITH FAN**
For roasting large joints of meat (legs, roast beef, chicken).
-  **CONVECTION BAKE**
For baking cakes with juicy fillings on a single shelf.
-  **DEFROST**
For defrosting food more quickly.
-  **LIGHT**

MATÅLSKARE	503 687 79		1		71	29
MATTRADITION	703 687 83 604 132 29 404 132 30		1		71	27
GB Manufacturer	Model	Built-in Oven	Number of cavity	Heat source : electrical	Usable volume (litres) Measured with any side grids and catalytic panels removed	Mass of the appliance (Kg)

MATÅLSKARE	0,81	95,3	A	0,99	1200
MATTRADITION	0,81	95,3	A	0,99	1200
GB Manufacturer	Fan Forced function (measured with any sliding shelves and catalytic panels removed)	Energy Efficiency Index	Energy Efficiency Class (Lowest Consumption)	Energy consumption (kWh/cycle) Conventional function (measured with any sliding shelves and catalytic panels removed)	Area of the largest baking sheet (cm ²)

400011341075

