

FRILLESBO

en



Design and Quality
IKEA of Sweden



ENGLISH

Please refer to the chapter IKEA GUARANTEE for contact details of the after sales customer service centre.

Contents

Safety information	4	Additional functions	19
Safety instructions	6	Hints and tips	20
Installation	9	Care and cleaning	23
Product description	10	Troubleshooting	26
Control panel	10	Technical data	27
Before first use	11	Energy efficiency	27
Daily use	12	Environmental concerns	29
Clock functions	17	IKEA guarantee	29
Using the accessories	18		

Subject to change without notice.

 **Safety information**

Before the installation and use of the appliance, carefully read the supplied instructions. The manufacturer is not responsible if an incorrect installation and use causes injuries and damage. Always keep the instructions with the appliance for future reference.

Children and vulnerable people safety

- This appliance can be used by children aged from 8 years and above and persons with reduced physical, sensory or mental capabilities or lack of experience and knowledge if they have been given supervision or instruction concerning the use of the appliance in a safe way and understand the hazards involved. Children of less than 8 years of age and persons with very extensive and complex disabilities shall be kept away from the appliance unless continuously supervised.
- Children should be supervised to ensure that they do not play with the appliance.
- Keep all packaging away from children and dispose of it appropriately.

- **WARNING:** The appliance and its accessible parts become hot during use. Keep children and pets away from the appliance when in use and when cooling down.
- If the appliance has a child safety device, it should be activated.
- Children shall not carry out cleaning and user maintenance of the appliance without supervision.

General safety

- This appliance is for cooking purposes only.
- This appliance is designed for single household domestic use in an indoor environment.
- This appliance may be used in offices, hotel guest rooms, bed & breakfast guest rooms, farm guest houses and other similar accommodation where such use does not exceed (average) domestic usage levels.
- Only a qualified person can install this appliance and replace the cable.
- **WARNING:** The appliance and its accessible parts become hot during use. Care should be taken to avoid touching heating elements.
- Always use oven gloves to remove or insert accessories or ovenware.
- Before any maintenance, cut the power supply.
- **WARNING:** Ensure that the appliance is switched off before replacing the lamp to avoid the possibility of electric shock.
- Do not use the appliance before installing it in the built-in structure.
- Do not use a steam cleaner to clean the appliance.
- Do not use harsh abrasive cleaners or sharp metal scrapers to clean the glass door since they can scratch the surface, which may result in shattering of the glass.

- If the mains power supply cable is damaged, it must be replaced by the manufacturer, its Authorised Service Centre or similarly qualified persons to avoid an electrical hazard.
- Before pyrolytic cleaning, remove all accessories and excessive deposits/spills from the appliance cavity.
- To remove the shelf supports first pull the front of the shelf support and then the rear end away from the side walls. Install the shelf supports in the opposite sequence.

Safety instructions

Installation

⚠ Warning! Only a qualified person must install this appliance.

- Remove all the packaging.
- Do not install or use a damaged appliance.
- Follow the installation instructions supplied with the appliance.
- Always take care when moving the appliance as it is heavy. Always use safety gloves and enclosed footwear.
- Do not pull the appliance by the handle.
- Install the appliance in a safe and suitable place that meets installation requirements.
- Keep the minimum distance from other appliances and units.
- Before mounting the appliance, check if the oven door opens without restraint.
- The appliance is equipped with an electric cooling system. It must be operated with the electric power supply.

Electrical connection

⚠ Warning! Risk of fire and electric shock.

- All electrical connections should be made by a qualified electrician.
- The appliance must be earthed.
- Make sure that the parameters on the rating plate are compatible with the

electrical ratings of the mains power supply.

- Always use a correctly installed shockproof socket.
- Do not use multi-plug adapters and extension cables.
- Make sure not to cause damage to the mains plug and to the mains cable. Should the mains cable need to be replaced, this must be carried out by our Authorised Service Centre.
- Do not let mains cables touch or come near the appliance door or the niche below the appliance, especially when it operates or the door is hot.
- The shock protection of live and insulated parts must be fastened in such a way that it cannot be removed without tools.
- Connect the mains plug to the mains socket only at the end of the installation. Make sure that there is access to the mains plug after the installation.
- If the mains socket is loose, do not connect the mains plug.
- Do not pull the mains cable to disconnect the appliance. Always pull the mains plug.
- Use only correct isolation devices: line protecting cut-outs, fuses (screw type fuses removed from the holder), earth leakage trips and contactors.
- The electrical installation must have an isolation device which lets you disconnect the appliance from the mains at all poles. The isolation device must have a contact opening width of minimum 3 mm.

- Fully close the appliance door before you connect the mains plug to the mains socket.

Use

 **Warning!** Risk of injury, burns and electric shock or explosion.

- Do not change the specification of this appliance.
- Make sure that the ventilation openings are not blocked.
- Do not let the appliance stay unattended during operation.
- Deactivate the appliance after each use.
- Be careful when you open the appliance door while the appliance is in operation. Hot air can be released.
- Do not operate the appliance with wet hands or when it comes in contact with water.
- Do not apply pressure on the open door.
- Do not use the appliance as a work surface or as a storage surface.
- Open the appliance door carefully. The use of ingredients with alcohol can cause a mixture of alcohol and air.
- Do not let sparks or open flames to come in contact with the appliance when you open the door.
- Always use glass and jars approved for preserving purposes.
- Do not put flammable products or items moistened with flammable products in, near or on the appliance.

 **Warning!** Risk of damage to the appliance.

- To prevent damage or discolouration to the enamel:
 - do not put ovenware or other objects directly on the bottom of the appliance's cavity.
 - do not put aluminium foil directly on the bottom of cavity of the appliance.
 - do not put water directly into the hot appliance.
 - do not keep moist dishes and food in the appliance after you finish the cooking.

- be careful when you remove or install the accessories.
- Discolouration of the enamel or stainless steel has no effect on the performance of the appliance.
- Use a deep pan for moist cakes. Fruit juices cause stains that can be permanent.
- Use only accessories supplied with this appliance or recommended by the manufacturer.
- Always cook with the appliance door closed.
- If the appliance is installed behind a furniture panel (e.g. a door) make sure the door is never closed when the appliance operates. Heat and moisture can build up behind a closed furniture panel and cause subsequent damage to the appliance, the housing unit or the floor. Do not close the furniture panel until the appliance has cooled down completely after use.

Care and Cleaning

 **Warning!** Risk of injury, fire, or damage to the appliance.

- Before maintenance, deactivate the appliance and disconnect the mains plug from the mains socket.
- Make sure the appliance is cold. There is a risk that the glass panels can break.
- Replace door glass panels immediately when they are damaged. Contact the Authorised Service Centre.
- Be careful when you remove the door from the appliance. The door is heavy!
- Clean the appliance regularly to prevent the deterioration of the surface material.
- Fat and food remaining in the appliance can cause fire.
- If you use an oven spray, follow the safety instructions on the packaging.

Pyrolytic cleaning

⚠ Warning! Risk of injury / fires / chemical emissions (fumes) during the pyrolytic mode.

- During pyrolytic cleaning, fumes are released that are not harmful to humans, including infants or persons with medical conditions.
- Unlike all humans, some birds and reptiles can be extremely sensitive to potential fumes emitted during the cleaning process of all pyrolytic ovens. Small pets can also be highly sensitive to the localized temperature changes in the vicinity of all pyrolytic ovens when the pyrolytic self-cleaning program is in operation.
- Before carrying out a pyrolytic self-cleaning function remove from the oven cavity:
 - any excess food residues, oil or grease spills / deposits.
 - any removable objects (including shelves, side rails / telescopic runners, etc. provided with the product) particularly any non-stick pots, pans, trays, utensils etc.
- Non-stick surfaces on pots, pans, trays, utensils, etc., can be damaged by the high temperature pyrolytic cleaning operation of all pyrolytic ovens and can be also a source for low level harmful fumes.
- Read carefully all the instructions for pyrolytic cleaning.
- Keep children away from the appliance while the pyrolytic cleaning is in operation. The appliance becomes very hot and hot air is released from the front cooling vents.
- Pyrolytic cleaning and first maximum temperature use are high temperature operations that can release fumes from cooking residues and construction materials, as such consumers are strongly advised to:
 - Provide good ventilation during and after each pyrolytic cleaning.

- Provide good ventilation during and after the first use at maximum temperature operation.
- Ensure that any pets (especially birds) are taken as far as possible from the vicinity of the appliance location during and after the pyrolytic cleaning and first use maximum temperature operation. Keeping them in a different room would be the preferred option during the pyrolytic cycle and until appliance has cooled down again to room temperature. Good ventilation has to be provided during and after (till appliance cools down) operations of the pyrolytic cycle and first maximum temperature use cycle.

Internal lighting

⚠ Warning! Risk of electric shock.

- Concerning the lamp(s) inside this product and spare part lamps sold separately: These lamps are intended to withstand extreme physical conditions in household appliances, such as temperature, vibration, humidity, or are intended to signal information about the operational status of the appliance. They are not intended to be used in other applications and are not suitable for household room illumination.
- This product contains a light source of energy efficiency class G.
- Use only lamps with the same specifications.

Service

- To repair the appliance contact the Authorised Service Centre.
- Use original spare parts only.

Disposal

⚠ Warning! Risk of injury or suffocation.

- Contact your municipal authority for information on how to discard the appliance correctly.

- Disconnect the appliance from the mains supply.
- Cut off the mains electrical cable close to the appliance and dispose of it.
- Remove the door to prevent children and pets from getting trapped inside the appliance.
- **Packaging material:**

The packaging material is recyclable. Plastic parts are marked with international abbreviations such as PE, PS, etc. Dispose of the packaging material in the containers provided for this purpose at your local waste management facility.

Installation

 **Warning!** Refer to Safety chapters.

Assembly

 Refer to the Assembly Instructions for the installation.

Electrical installation

 **Warning!** Only a qualified person must do the electrical installation.

 The manufacturer is not responsible if you do not follow the safety precautions from the Safety chapters.

This oven is only supplied with a main cable.

Cable

Cable types applicable for installation or replacement:

H07 RN-F, H05 RN-F, H05 RRF, H05 VV-F, H05 V2V2-F (T90), H05 BB-F

For the section of the cable refer to the total power on the rating plate. You can also refer to the table:

Total power (W)	Section of the cable (mm ²)
maximum 1380	3 x 0.75
maximum 2300	3 x 1
maximum 3680	3 x 1.5

The earth cord (green / yellow cable) must be 2 cm longer than the brown phase and blue neutral cables.

Product description

General overview

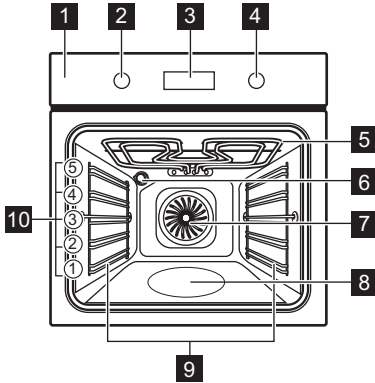

- 1 Control panel
- 2 Knob for the heating functions
- 3 Display

- 4 Control knob
- 5 Heating element
- 6 Lamp
- 7 Fan
- 8 Cavity embossment
- 9 Shelf support, removable
- 10 Shelf positions

Accessories

- **Wire shelf** x 1
For cookware, cake tins, roasts.
- **Baking tray** x 1
For cakes and biscuits.
- **Grill- / Roasting pan** x 1
To bake and roast or as pan to collect fat.
- **Telescopic runners** x 1 set
For shelves and trays.





Control panel

Turning the appliance on and off

To turn on the appliance:

1. Press the knobs. The knobs come out.
 2. Turn the knob for the heating functions to select a function.
 3. Turn the control knob to adjust settings.
- To turn off the appliance: turn the knob for the heating functions to the off position .

Control panel overview





	Press to set timer functions.
	Press and hold to set the function: Fast Heat Up.
	Press to turn the appliance lamp on and off.
	Press and hold to set the function: Lock.

OK	Press to confirm your selection.
----	----------------------------------

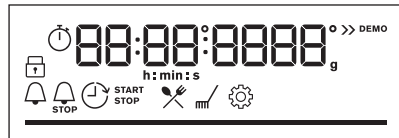
Display indicators

Display with key functions:



	The appliance is locked.
	Submenu: Assisted Cooking.
	Submenu: Cleaning.
	Submenu: Settings

	Fast Heat Up is activated.
	Steam cooking is activated.
	Minute minder is activated.
	Cooking time is activated.
	Time Delayed Start is activated.

	Uptimer is activated.
	Progress bar - visually indicates when the appliance reaches the set temperature or when the cooking time comes to an end.

Before first use

Warning! Refer to Safety chapters.

Setting the time

After the first connection to the mains, wait until the display shows: "00:00" or "12:00" (depending on the model).

1. Turn the control knob to set the time.
2. Press OK.

Initial preheating and cleaning

Preheat the empty appliance before the first use and contact with food. The appliance can emit unpleasant smell and smoke. Ventilate the room during preheating.

1. Remove all accessories and removable shelf supports from the appliance.
2. Set the function . Set the maximum temperature. Refer to Daily use. Let the appliance operate for 1 h.
3. Set the function . Set the maximum temperature. Let the appliance operate for 15 min.
4. Set the function . Set the maximum temperature. Let the appliance operate for 15 min.
5. Turn off the appliance and wait until it is cold.
6. Clean the appliance and the accessories only with a microfibre cloth, warm water and a mild detergent.

7. Put the accessories and removable shelf supports back to their initial position.

Mechanical child lock

The oven has the mechanical child lock installed. It is the door lock on the right side of the oven, below the control panel.

To open the oven door with the child lock:

1. Push and hold up the child lock.
2. Pull the door handle to open the door. Close the oven door without pushing the child lock.

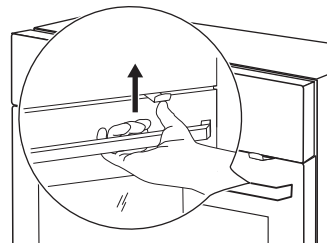

To remove the child lock:

1. Open the door and remove the child lock with the torx key supplied with the oven.
2. Fix the screw back after removing the child lock.

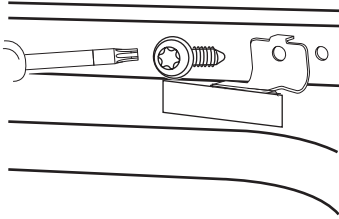

Daily use

Warning! Refer to Safety chapters.

Heating functions

	<p>True Fan Cooking To roast meat and bake cakes. Set a lower temperature than for Conventional Cooking as the fan distributes heat evenly in the oven interior.</p>
	<p>Conventional Cooking To bake and roast food on one shelf position.</p>
	<p>SteamBake To add humidity during the cooking. To get the right colour and crispy crust during baking. To give more juiciness during reheating.</p>
	<p>Frozen Foods To make convenience food crispy, e.g. french fries, potato wedges or spring rolls.</p>
	<p>Pizza Function To bake pizza and other dishes that require more heat from below.</p>
	<p>Bottom Heat To make browning and crispy bottom. Use the lowest shelf position.</p>

	<p>Moist Fan Baking This function is designed to save energy during cooking. When you use this function, the temperature inside the appliance may differ from the set temperature. The residual heat is used. The heating power may be reduced. For more information refer to Daily use, Notes on: Moist Fan Baking.</p>
	<p>Grill To grill thin pieces of food and to toast bread.</p>
	<p>Turbo Grilling To roast large meat joints or poultry with bones on one shelf position. To bake gratins and to brown.</p>

i The lamp may turn off automatically at a temperature below 80°C during some oven functions.

Notes on: Moist Fan Baking

This function was used to comply with the energy efficiency class and ecodesign requirements (according to EU 65/2014 and EU 66/2014). Tests according to: IEC/EN 60350-1.

The oven door should be closed during cooking so that the function is not interrupted and the oven operates with the highest energy efficiency possible.

When you use this function the lamp automatically turns off after 30 sec.

For the cooking instructions refer to Hints and tips, Moist Fan Baking.

Setting: Heating functions

1. Turn the knob for the heating functions to select a heating function.
2. Turn the control knob to set the temperature.

 Fast Heat Up - press and hold to shorten the heating time. It is available for some heating functions. Fan may turn on automatically.

Setting: SteamBake - Steam cooking



1. Make sure that the appliance is cold.
2. Fill the cavity embossment with maximum 250 ml of tap water. Do not refill the cavity embossment during cooking or when the appliance is hot.
3. Turn the knob for the heating functions to select the heating function .
4. Turn the control knob to set the temperature.
5. Preheat the empty appliance for 10 min to create humidity.
6. Insert the food in the appliance.
7. When the cooking ends, turn the knob for the heating functions to the off position to turn off the appliance.
8. When the appliance is cold, remove the remaining water from the cavity embossment with a soft cloth.

 **Warning!** Carefully open the door. Released humidity can cause burns.

Entering: Menu 

Open the Menu to access Assisted Cooking dishes and settings.



1. Turn the knob for the heating functions to .

The display shows , , .





2. Turn the control knob and select the icon to enter submenu. Press **OK**.

Setting: Assisted Cooking 

Assisted Cooking submenu consists of programmes that are designed for dedicated dishes. Programmes start with a suitable setting. You can adjust the time and the temperature during cooking.



















1. Turn the knob for the heating functions to .
2. Turn the control knob to select . Press **OK**.
3. Turn the control knob to select a dish (P1 - P...), Press **OK**.
4. Turn the control knob to adjust the weight. Option is available for selected dishes. Press **OK**.
5. Place the food inside the appliance. Press **OK**.
6. When the function ends, check if the food is ready. Extend the cooking time, if needed.

































Submenu: Assisted Cooking

Legend	
	Weight adjustment available.
	Fill the cavity embossment with water for steam cooking.
	Preheat the appliance before you start cooking.
	Shelf level. Refer to Product description.



The display shows **P** and a **number** of the dish that you can check in the table.

	Dish	Weight	Shelf level / Accessory
P1	Roast beef, rare	1 - 1.5 kg; 4 - 5 cm thick pieces	☐ 2; baking tray Fry the meat for a few minutes in a hot pan. Insert to the appliance.
P2	Roast beef, medium		
P3	Roast beef, well done		
P4	Steak, medium	180 - 220 g per piece; 3 cm thick slices	☐☐ 3 ; roasting dish on wire shelf Fry the meat for a few minutes in a hot pan. Insert to the appliance.
P5	Beef roast / braised (prime rib, top round, thick flank)	1.5 - 2 kg	☐☐ 2 ; roasting dish on wire shelf Fry the meat for a few minutes in a hot pan. Add liquid. Insert to the appliance.
P6	Roast beef, rare (slow cooking)	1 - 1.5 kg; 4 - 5 cm thick pieces	☐ 2; baking tray Fry the meat for a few minutes in a hot pan. Insert to the appliance.
P7	Roast beef, medium (slow cooking)		
P8	Roast beef, well done (slow cooking)		
P9	Fillet of beef, rare (slow cooking)	0.5 - 1.5 kg; 5 - 6 cm thick pieces	☐ 2; baking tray Fry the meat for a few minutes in a hot pan. Insert to the appliance.
P10	Fillet of beef, medium (slow cooking)		
P11	Fillet of beef, done (slow cooking)		
P12	Veal roast (e.g. shoulder)	0.8 - 1.5 kg; 4 cm thick pieces	☐☐ 2 ; roasting dish on wire shelf Fry the meat for a few minutes in a hot pan. Add liquid. Insert to the appliance. Roast covered.
P13	Pork roast neck or shoulder	1.5 - 2 kg	☐☐ 2 ; roasting dish on wire shelf Add 200 ml liquid to the roasting dish.

	Dish	Weight	Shelf level / Accessory
P14	Pulled pork (slow cooking)	1.5 - 2 kg	 2; baking tray Turn the meat after half of the cooking time to get an even browning.
P15	Pork loin, fresh	1 - 1.5 kg; 5 - 6 cm thick pieces	 2; roasting dish on wire shelf Fry the meat for a few minutes in a hot pan. Insert to the appliance.
P16	Pork spare ribs	2 - 3 kg; use raw, 2 - 3 cm thin spare ribs	 3; deep pan Add liquid to cover the bottom of a dish. Turn the meat after half of the cooking time.
P17	Lamb leg with bones	1.5 - 2 kg; 7 - 9 cm thick pieces	 2; roasting dish on baking tray Add liquid. Turn the meat after half of the cooking time.
P18	Whole chicken	1 - 1.5 kg; fresh	  2; 200 ml; casserole dish on baking tray Turn the chicken after half of the cooking time to get an even browning.
P19	Half chicken	0.5 - 0.8 kg	 3; baking tray
P20	Chicken breast	180 - 200 g per piece	  2; casserole dish on wire shelf Fry the meat for a few minutes in a hot pan.
P21	Chicken legs, fresh	-	 3; baking tray If you marinated chicken legs first, set lower temperature and cook them longer.
P22	Duck, whole	2 - 3 kg	  2; roasting dish on wire shelf Put the meat on roasting dish. Turn the duck after half of the cooking time.
P23	Goose, whole	4 - 5 kg	  2; deep pan Put the meat on deep baking tray. Turn the goose after half of the cooking time.
P24	Meat loaf	1 kg	 2; wire shelf
P25	Whole fish, grilled	0.5 - 1 kg per fish	 2; baking tray Fill the fish with butter, spices and herbs.
P26	Fish fillet	-	  3; casserole dish on wire shelf
P27	Cheesecake	-	 2; 28 cm springform tin on wire shelf

	Dish	Weight	Shelf level / Accessory
P28	Apple cake	-	  2;  100 - 150 ml; baking tray
P29	Apple tart	-	 2; pie form on wire shelf
P30	Apple pie	-	  2;  100 - 150 ml;  22 cm pie form on wire shelf
P31	Brownies	2 kg of dough	 3; deep pan
P32	Muffins	-	  2;  100 - 150 ml; muffin tray on wire shelf
P33	Loaf cake	-	 2; loaf pan on wire shelf
P34	Baked potatoes	1 kg	 2; baking tray Put the whole potatoes with skin on baking tray.
P35	Wedges	1 kg	 3; baking tray lined with baking paper Cut potatoes into pieces.
P36	Grilled mixed vegetables	1 - 1.5 kg	 3; baking tray lined with baking paper Cut the vegetables into pieces.
P37	Croquettes, frozen	0.5 kg	 3; baking tray
P38	Pommes, frozen	0.75 kg	 3; baking tray
P39	Meat / vegetable lasagna with dry pasta sheets	1 - 1.5 kg	 2; casserole dish on wire shelf
P40	Potato gratin (raw potatoes)	1 - 1.5 kg	 1; casserole dish on wire shelf Rotate the dish after half of the cooking time.
P41	Pizza fresh, thin	-	  2;  100 ml; baking tray lined with baking paper
P42	Pizza fresh, thick	-	  2; baking tray lined with baking paper
P43	Quiche	-	 2; baking tin on wire shelf
P44	Baguette / Ciabatta / White bread	0.8 kg	  2;  150 ml; baking tray lined with baking paper More time needed for white bread.
P45	Whole grain / Rye / Dark bread	1 kg	  2;  150 ml; baking tray lined with baking paper / loaf pan on wire shelf

Changing: Settings

1. Turn the knob for the heating functions to .
2. Turn the control knob to select . Press **OK**.
3. Turn the control knob to select the setting. Press **OK**.
4. Turn the control knob to adjust the value. Press **OK**.
5. Turn the knob for the heating functions to the off position to exit Menu.





Submenu: Settings

	Setting	Value
01	Time of day	Change
02	Display brightness	1 - 5



	Setting	Value
03	Key tones	1 - Beep, 2 - Click, 3 - Sound off
04	Buzzer volume	1 - 4
05	Uptimer	On / Off
06	Light	On / Off
07	Fast Heat Up	On / Off
08	Cleaning Reminder	On / Off
09	Demo mode	-
10	Software version	Check
11	Reset all settings	Yes / No

Clock functions



Timer functions description

 Minute minder	To set a countdown timer. When the timer ends, the signal sounds. This function has no effect on the operation of the appliance and can be set at any time.
 Cooking time	To set cooking duration. When the timer ends, the signal sounds and the heating function will automatically turn off.
 Time Delayed Start	To postpone the start and / or end of cooking.
 Uptimer	To show how long the appliance operates. Maximum is 23 h 59 min. This function has no effect on the operation of the appliance and can be set at any time.



Setting: Minute minder

1. Press .
- The display shows: 0:00 and .
2. Turn the control knob to set the Minute minder.
 3. Press **OK**. The timer starts counting down immediately.

Setting: Cooking time

1. Turn the knobs to select the heating function and to set the temperature.
2. Press  until the display shows: 0:00 and .
3. Turn the control knob to set the Cooking time.
4. Press **OK**. The timer starts counting down immediately.
5. When the time ends, press **OK** and turn the knob for the heating functions to the off position.

Setting: Time Delayed Start 

1. Turn the knobs to select the heating function and to set the temperature.
2. Press  until the display shows:  and START .
3. Turn the control knob to set the start time.
4. Press OK.

The display shows: --:--  STOP .



5. Turn the control knob to set the end time.
6. Press OK.

The timer starts counting down at a set start time.

7. When the time ends, press OK and turn the knob for the heating functions to the off position.

2. Turn the control knob to select  / Uptimer. Refer to Daily use, Menu: Settings.
3. Press OK.
4. Turn the control knob to turn the Uptimer on and off.
5. Press OK.

Setting: Time of day

1. Turn the knob for the heating functions to  to enter Menu.
2. Turn the control knob to select  / Time of day. Refer to Daily use, Menu: Settings.
3. Turn the control knob to set the clock.
4. Press OK.

Setting: Uptimer 

1. Turn the knob for the heating functions to  to enter Menu.

Using the accessories

 **Warning!** Refer to Safety chapters.

Inserting accessories

A small indentation at the top increases safety and provides tilt protection. The indentations are also anti-tip devices. The rim around the shelf prevents cookware from slipping off the shelf.

Wire shelf

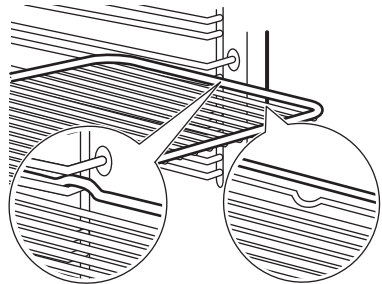

Insert the shelf between the guide bars of the shelf support and make sure that the feet point down. Make sure that the shelf touches the back of the oven interior.

Baking tray / Deep pan

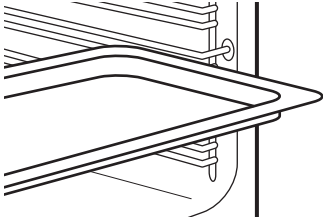

Push the tray between the guide bars of the shelf support. Place the baking tray with the slope towards the back of the oven interior.

Using: Telescopic runners

- i** Keep the installation instructions for the telescopic runners for future use.

With telescopic runners you can put in and remove wire shelves and trays easily.

- ⚠** **Caution!** Do not clean the telescopic runners in the dishwasher. Do not lubricate the telescopic runners.

1. Pull out the right and left hand telescopic runners.

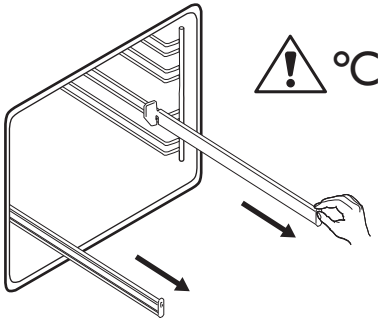

2. Put the wire shelf on the telescopic runners and carefully push them into the oven. Make sure you push back the telescopic runners fully in the oven before you close the oven door.

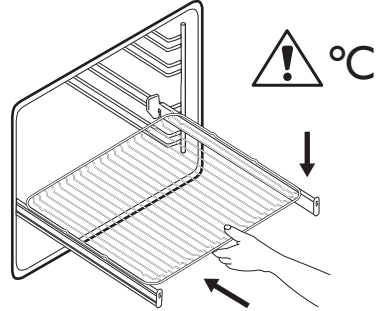

Additional functions

Lock 

This function prevents an accidental change of the appliance function.

When activated while the appliance is in use, it locks the control panel, ensuring that the current cooking settings continue uninterrupted.

When activated while the appliance is off, it keeps the control panel locked, preventing the appliance from being turned on unintentionally.

 - press and hold to turn on the function.

A signal sounds.  - flashes 3 times when the lock is turned on.



 - press and hold to turn off the function.

Automatic switch-off

For safety reasons, if the heating function is active and no settings are changed, the appliance will turn off automatically after a certain period of time.

Table with automatic switch off times for given oven temperature range.

 (°C)	 (h)
30 - 115	12.5

 (°C)	 (h)
120 - 195	8.5
200 - 245	5.5
250 - maximum	3

If you intend to run a heating function for a duration exceeding the automatic switch-off time, set the cooking time. Refer to Clock functions.

The Automatic switch-off does not work with the functions: Light, Time Delayed Start.

Cooling fan

When the appliance operates, the cooling fan turns on automatically to keep the surfaces of the appliance cool. If you turn off the appliance, the cooling fan can continue to operate until the appliance cools down.

Hints and tips

Cooking recommendations

The temperature and cooking times in the tables are for guidance only. They depend on the recipes, quality and quantity of the ingredients used.



Your appliance may bake or roast differently than your previous appliance. The hints below show recommended settings for temperature, cooking time and shelf position for specific types of food.



Count the shelf positions from the bottom of the oven floor.

If you cannot find the settings for a specific recipe, look for a similar one.

For energy saving tips refer to Energy efficiency.

Symbols used in the tables:

	Food type
	Heating function

°C	Temperature
	Accessory
	Shelf position
	Cooking time (min)





Moist Fan Baking - recommended accessories





Use dark and non-reflective tins and containers. They have better heat absorption than light colour and reflective dishes.

- **Pizza pan** - dark, non-reflective, diameter 28 cm
- **Baking dish** - dark, non-reflective, diameter 26 cm
- **Ramekins** - ceramic, diameter 8 cm, height 5 cm
- **Flan base tin** - dark, non-reflective, diameter 28 cm

Moist Fan Baking





For the best results follow suggestions listed in the table below.





		°C		
Sweet rolls, 16 pieces	baking tray or dripping pan	180	2	20 - 30
Rolls, 9 pieces	baking tray or dripping pan	180	2	30 - 40
Pizza, frozen, 0.35 kg	wire shelf	220	2	10 - 15
Swiss Roll	baking tray or dripping pan	170	2	25 - 35
Brownie	baking tray or dripping pan	175	3	25 - 30
Soufflè, 6 pieces	ceramic ramekins on wire shelf	200	3	25 - 30
Sponge flan base	flan base tin on wire shelf	180	2	15 - 25
Victoria sandwich	baking dish on wire shelf	170	2	40 - 50
Poached fish, 0.3 kg	baking tray or dripping pan	180	3	20 - 25
Whole fish, 0.2 kg	baking tray or dripping pan	180	3	25 - 35
Fish fillet, 0.3 kg	pizza pan on wire shelf	180	3	25 - 30
Poached meat, 0.25 kg	baking tray or dripping pan	200	3	35 - 45
Shashlik, 0.5 kg	baking tray or dripping pan	200	3	25 - 30
Cookies, 16 pieces	baking tray or dripping pan	180	2	20 - 30
Macaroons, 24 pieces	baking tray or dripping pan	180	2	25 - 35
Muffins, 12 pieces	baking tray or dripping pan	170	2	30 - 40

		°C		
Savory pastry, 20 pieces	baking tray or dripping pan	180	2	25 - 30
Short crust biscuits, 20 pieces	baking tray or dripping pan	150	2	25 - 35
Tartlets, 8 pieces	baking tray or dripping pan	170	2	20 - 30
Vegetables, poached, 0.4 kg	baking tray or dripping pan	180	3	35 - 45
Vegetarian omelette	pizza pan on wire shelf	200	3	25 - 30
Mediterranean vegetables, 0.7 kg	baking tray or dripping pan	180	4	25 - 30

Information for test institutes

Tests according to IEC 60350-1.

				°C	
Small cakes, 20 per tray	Conventional Cooking	Baking tray	3	170	20 - 35
Small cakes, 20 per tray	True Fan Cooking	Baking tray	3	150 - 160	20 - 35
Small cakes, 20 per tray	True Fan Cooking	Baking tray	2 and 4	150 - 160	20 - 35
Apple pie, 2 tins Ø20 cm	Conventional Cooking	Wire shelf	2	180	70 - 90
Apple pie, 2 tins Ø20 cm	True Fan Cooking	Wire shelf	2	160	70 - 90
Fatless sponge cake, cake mould Ø26 cm ¹⁾	Conventional Cooking	Wire shelf	2	170	40 - 50
Fatless sponge cake, cake mould Ø26 cm ¹⁾	True Fan Cooking	Wire shelf	2	160	40 - 50
Fatless sponge cake, cake mould Ø26 cm ¹⁾	True Fan Cooking	Wire shelf	2 and 4	160	40 - 60
Shortbread	True Fan Cooking	Baking tray	3	140 - 150	20 - 40

				°C	
Shortbread	True Fan Cooking	Baking tray	2 and 4	140 - 150	25 - 45
Shortbread	Conventional Cooking	Baking tray	3	140 - 150	25 - 45
Toast ¹⁾	Grill	Wire shelf	4	max.	1 - 5

1) Preheat the appliance for 10 minutes.

Care and cleaning

 **Warning!** Refer to Safety chapters.

Notes on cleaning

Cleaning agents

- Clean the front of the appliance only with a microfibre cloth with warm water and a mild detergent.
- Use a cleaning solution to clean metal surfaces.
- Clean stains with a mild detergent.

Everyday use

- Clean the interior of the appliance after each use. Fat accumulation or other residue may cause fire.
- Moisture can condense in the appliance or on the door glass panels. To decrease the condensation, let the appliance work for 10 minutes before cooking. Do not store food in the appliance for longer than 20 minutes. Dry the interior of the appliance only with a microfibre cloth after each use.

Accessories

- Clean all accessories after each use and let them dry. Use only a microfibre cloth with warm water and a mild detergent. Do not clean the accessories in a dishwasher.
- Do not clean the non-stick accessories using abrasive cleaner or sharp-edged objects.

Cleaning the cavity embossment

Clean the cavity embossment to remove limestone residue after cooking with steam.

 For the function: SteamBake clean the oven every 5 - 10 cooking cycles.

1. Pour 250 ml of white vinegar or citric acid into the cavity embossment. Use maximum 6% acidity vinegar without any additives.
2. Let the vinegar dissolve the limestone residue at the ambient temperature for 30 minutes.
3. Clean the cavity with warm water and a soft cloth.

Removing the shelf supports

Remove the shelf supports to clean the appliance.

1. Turn off the appliance and wait until it is cold.
2. Pull the front of the shelf support away from the side wall.
3. Pull the rear end of the shelf support away from the side wall and remove it.

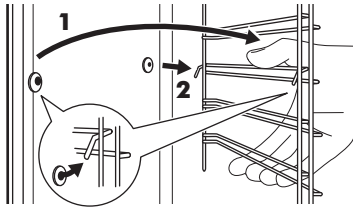

- 4. Put the shelf supports back to the initial position. Repeat the steps in the reverse order.

If the telescopic runners are supplied, its retaining pins must point to the front.

Pyrolytic Cleaning

Warning! There is a risk of burns.

Caution! If there are other appliances installed in the same cabinet, do not use them at the same time as this function. It can cause damage to the oven.

Do not start the function if you did not fully close the oven door.

- 1. Make sure that the appliance is cold.
- 2. Remove all accessories.
- 3. Clean the oven interior and the inner door glass with warm water, a soft cloth and a mild detergent.
- 4. Turn the knob for the heating functions to to enter Menu.
- 5. Turn the control knob to select and press OK.

Cleaning programme	Duration
C1 - Light cleaning	1 h
C2 - Normal cleaning	1 h 30 min
C3 - Thorough cleaning	2 h 30 min

- 6. Turn the control knob to select the cleaning programme and press OK.

- 7. Press OK to start cleaning. When the cleaning starts, the appliance door is locked and the lamp is off. Until the door unlocks the display shows .
- 8. After cleaning, turn the knob for the heating functions to the off position.
- 9. Wait until the appliance is cold and the door unlocks. Clean the oven interior with soft cloth and water.

Cleaning Reminder

When flashes on the display after cooking session, the appliance reminds you to clean it with pyrolytic cleaning. You can turn off the reminder in the submenu: Settings. Refer to Daily use, Changing: Settings.

Removing and installing door

The oven door has three glass panels. You can remove the oven door and the internal glass panels to clean them. Read the whole "Removing and installing door" instruction before you remove the glass panels.

Caution! Do not use the appliance without the glass panels.

- 1. Open the door fully and hold both hinges.

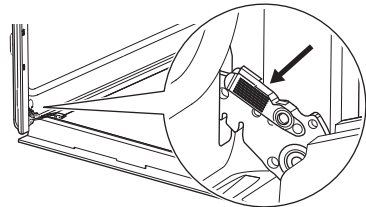

- 2. Lift and pull the latches until they click.

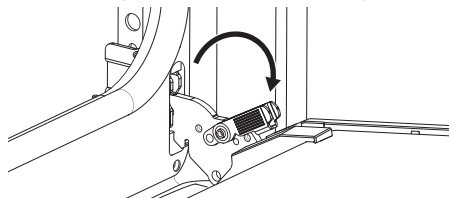

- 3. Close the oven door halfway to the first opening position. Then lift and pull to remove the door from its seat.

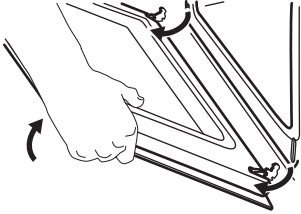

- 4. Put the door on a soft cloth on a stable surface.
- 5. Hold the door trim **B** on the top edge of the door at the two sides and push inwards to release the clip seal.

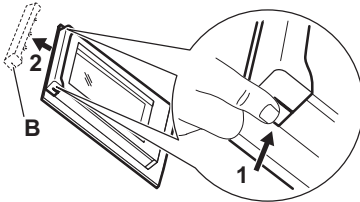

- 6. Pull the door trim to the front to remove it.
- 7. Hold the door glass panels by their top edge and carefully pull them out one by one. Start from the top panel. Make sure the glass slides out of the supports completely.

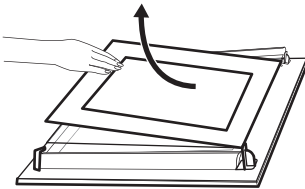

- 8. Clean the glass panels with water and soap. Dry the glass panels carefully. Do not clean the glass panels in the dishwasher.
- 9. After cleaning, install the glass panels, the door trim and the oven door, close the latches on the both hinges.

If the door is installed correctly, you will hear a click when closing the latches.

Make sure that you put the glass panels (**A** and **B**) back in the correct sequence. Check for the symbol / printing on the side of the glass panel. Each of the glass panels looks different to make the disassembly and assembly easier.

The screen-printing zone must face the inner side of the door. Make sure that after the installation the surface of the glass panel frame on the screen-printing zones is not rough when you touch it.

When installed correctly, the door trim clicks.

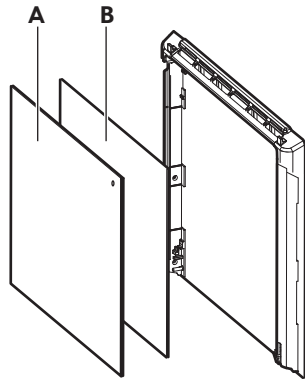

Make sure that you install the middle glass panel in the seats correctly.

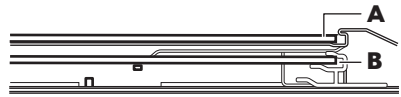

Replacing the lamp

Warning! Risk of electric shock. The lamp can be hot.

- 1. Turn off the appliance and wait until it is cold.
- 2. Disconnect the appliance from the mains.
- 3. Place the cloth on the oven floor.

⚠ Caution! Always hold the halogen lamp with a cloth to prevent grease residue from burning on the lamp.

2. Clean the glass cover.
3. Replace the lamp with a suitable 300°C heat-resistant lamp.
4. Install the glass cover.

Back lamp

1. Turn the glass cover to remove it.

Troubleshooting

⚠ Warning! Refer to Safety chapters.

What to do if...

Problem	Check if...
The appliance does not heat up.	The automatic switch-off is deactivated.
The appliance does not heat up.	The appliance door is closed.
The appliance does not heat up.	The fuse is not blown.
The appliance does not heat up.	Lock is deactivated.
The lamp is turned off.	Moist Fan Baking - is activated.
The lamp does not work.	The lamp is burnt out.
Err C3	The appliance door is closed or the door lock is not broken.
Err F102	The appliance door is closed.
Err F102	The door lock is not broken.
The display shows 00:00.	There was a power cut. Set the time of day.
The water leaks out of the cavity embossment.	There is too much water in the cavity embossment.

i If the display shows an error code that is not in this table, turn the house fuse off and on to restart the appliance. If the error code recurs contact an Authorised Service Centre.

Service data

If you cannot find a solution to the problem yourself, contact an Authorised Service Centre.

The necessary data for the service centre is on the rating plate. The rating plate is located on the front frame of the appliance. It is visible when you open the door. Do not remove the rating plate from the appliance.

We recommend that you write the data here:

Model (MOD.):	
---------------	--

Product number (PNC):	
Serial number (S.N.):	

Technical data

Technical data

Dimensions (internal)	Width Height Depth	480 mm 361 mm 416 mm
Area of baking tray	1438 cm ²	
Top heating element	2300 W	
Bottom heating element	1000 W	
Grill	2300 W	
Ring	2400 W	
Total rating	2990 W	
Voltage	220 - 240 V	
Frequency	50 - 60 Hz	
Number of functions	9	

Energy efficiency

Product information sheet and product information according to EU energy labelling and ecodesign regulations

Supplier's name	IKEA
Model identification	FRILLESBO 806.139.96
Energy efficiency index	81.2
Energy efficiency class	A+
Energy consumption with a standard load, conventional mode	0.93 kWh/cycle
Energy consumption with a standard load, fan-forced mode	0.69 kWh/cycle

Number of cavities	1
Heat source	Electricity
Volume	72 l
Type of oven	Built-in oven
Mass	33.0 kg

Product information for power consumption and maximum time to reach applicable low power mode

Power consumption

Power consumption in standby	0.8 W
Maximum time needed for the equipment to automatically reach the applicable low power mode	20 min

Energy saving tips

Following tips below will help you save energy when using your appliance.

Make sure that the appliance door is closed when the appliance operates. Do not open the appliance door too often during cooking. Keep the door gasket clean and make sure it is well fixed in its position.

Use metal cookware and dark, non-reflective tins and containers to improve energy saving.

Do not preheat the appliance before cooking unless specifically recommended.

Keep breaks between baking as short as possible when you prepare a few dishes at one time.

Cooking with fan

When possible, use the cooking functions with fan to save energy.

Residual heat

When the cooking duration is longer than 30 min, reduce the appliance temperature to

minimum 3 - 10 min before the end of cooking. The residual heat inside the appliance will continue to cook.

Use the residual heat to keep the food warm or warm up other dishes.

When you turn off the appliance, the display shows the residual heat or temperature.

Keep food warm

Choose the lowest possible temperature setting to use residual heat and keep the food warm. The residual heat indicator or temperature appears on the display.

Cooking with the lamp off

Turn off the lamp during cooking. Turn it on only when you need it.

Moist Fan Baking

Function designed to save energy during cooking.

When you use this function the lamp automatically turns off after 30 sec. You may turn on the lamp again but this action will reduce the expected energy savings.

Environmental concerns

Recycle materials with the symbol . Put the packaging in relevant containers to recycle it. Help protect the environment and human health by recycling waste of electrical and electronic appliances. Do not dispose of

appliances marked with the symbol  with the household waste. Return the product to your local recycling facility or contact your municipal office.

IKEA guarantee

How long is the IKEA guarantee valid?

This guarantee is valid for 5 years from the original date of purchase of your appliance at IKEA, IKEA Pty Ltd, ABN 84006270757 or IKEA NEW ZEALAND LIMITED, NZBN 9429047515468. The original sales receipt is required as proof of purchase. If service work is carried out under guarantee, this will not extend the guarantee period for the appliance.

Who will execute the service?

If you encounter any trouble with the appliance and wish to register a service call or make a claim, please contact your local IKEA customer support centre. The centre will provide service through its own operations or authorized service partner network.

The principal address and contact details in Australia and New Zealand:

IKEA Pty Ltd for Australia and IKEA New Zealand Limited for New Zealand
IKEA Service Office L1 Clock Tower, 630 Princes Highway Tempe, NSW 2044

Contact IKEA customer support centre at www.IKEA.com

Australia: (02) 9010 0264
New Zealand: Refer Contact Us Section on New Zealand Website

What does this guarantee cover?

The guarantee covers faults of the appliance, which have been caused by faulty construction or material faults from the date of purchase from IKEA. This guarantee applies to domestic use only. The products have been designed and tested for domestic purposes only and this guarantee does not cover damage arising from use of the Product in a commercial environment.

The exceptions are specified under the headline "What is not covered under this guarantee?" Within the guarantee period, the costs to remedy the fault e.g. repairs, parts, labour and travel will be covered, provided that the appliance is accessible for repair without special expenditure. Replaced parts become the property of IKEA.

The guarantee exists only if the appliance complies and is installed in accordance with:

- The technical specifications.
- The Assembly Instructions and user manual Safety Information.

IKEA's guarantee is subject to:

- Australian Consumer Law see Schedule 2 to Competition and Consumer Act, 2010.
- New Zealand Consumer Guarantees Act 1993.

This guarantee is in addition to any non-excludable statutory warranties in Australia and New Zealand.

What will IKEA do to correct the problem?

IKEA appointed service provider will examine the product and decide, at its sole discretion, if it is covered under this guarantee. They will notify you as to whether your claim is

covered under this guarantee. If your claim is approved, the IKEA service provider or its authorized service partner, will then, at its sole discretion, either repair the defective product or replace it with the same or a comparable product.

What is not covered under this guarantee?

- Normal wear and tear.
- Deliberate or negligent damage, damage caused by failure to observe operating instructions, incorrect installation or by connection to the wrong voltage, damage caused by chemical or electro-chemical reaction, rust, corrosion or water damage including but not limited to damage caused by excessive lime in the water supply, damage caused by abnormal environmental conditions.
- Consumable parts including batteries and lamps.
- Non-functional and decorative parts which do not affect normal use of the appliance, including any scratches and possible colour differences.
- Accidental damage caused by foreign objects including insect or vermin infestation or substances and cleaning or unblocking of filters, drainage systems or soap drawers.
- Damage to the following parts: ceramic glass, accessories, crockery and cutlery baskets, feed and drainage pipes, seals, lamps and lamp covers, screens, knobs, casings and parts of casings. Unless such damages can be proved to have been caused by production faults.
- Cases where no fault could be found during a technician's visit.
- Repairs not carried out by our appointed service providers and/or an authorized service contractual partner or where non-original parts have been used.
- Repairs caused by installation which is faulty or not according to specification.
- The use of the appliance in a non-domestic environment i.e. professional use.
- Transportation damages. If a customer transports the product to their home or

other address, IKEA is not liable for any damage that may occur during transport. However, if IKEA delivers the product to the customer's delivery address, then damage to the product that occurs during this delivery will be covered by this guarantee.

- Cost for carrying out the initial installation of the IKEA appliance. However, if an IKEA service provider or its authorized service partner repairs or replaces the appliance under the terms of this guarantee, the service provider or its authorized service partner will re-install the repaired appliance or install the replacement, if necessary.
- The appliance's serial number or warranty seal has been removed or defaced.

How country law applies

Our goods come with guarantees that cannot be excluded under the Consumer Law in Australia and New Zealand. You are entitled to a replacement or refund for a major failure and compensation for any other reasonably foreseeable loss or damage. You are also entitled to have the goods repaired or replaced if the goods fail to be of acceptable quality and the failure does not amount to a major failure.

This guarantee is not intended in any way to limit or exclude such rights and remedies that you may have under law.

You can find out more information on the websites:

- Australia: www.accc.gov.au
- New Zealand: <https://comcom.govt.nz/>

<https://www.consumerprotection.govt.nz/general-help/consumer-laws/consumer-guarantees-act>

Area of validity

The IKEA guarantee gives you specific legal rights, which cover or exceed all the local legal demands. However these conditions do not limit in any way consumer rights described in the local legislation.

What you must do to make a claim under the guarantee:

To make a claim under the guarantee contact IKEA customer support centre.



- i** Please describe the problem that you are facing with the appliance in detail along with your product article number (8 digit code), the Serial Number (8 digit code that can be found on the rating plate) and date of purchase at the time of call registration.

- i** **SAVE THE SALES RECEIPT!** Kindly keep all these details and original invoice of purchase handy during the service technician's visit to enable him to carry out the job. It is your proof of purchase and required for the guarantee to apply. Note that the receipt reports also the IKEA article name and number (8 digit code) for each of the appliances you have purchased.



701131677-A-452025

