

FOLKLIG

AU

Table of contents

Safety information	4	Technical Data	12
Product description	6	Electrical connection	13
Daily use	7	Electrical connection for Australia	14
Maintenance and cleaning	10	Environmental concerns	14
What to do if	11	IKEA GUARANTEE	15

Safety Information

Your safety and that of others is paramount.

This manual and the appliance itself provide important safety warnings, to be read and observed at all times.

 This is the safety alert symbol, pertaining to safety, which alerts users to potential hazards to themselves and others.

All safety messages are preceded by the safety alert symbol and the following terms:

 **DANGER** Indicates a hazardous situation which, if not avoided, will result in serious injury.

 **WARNING** Indicates a hazardous situation which, if not avoided, could result in serious injury.

All safety warnings give specific details of the potential risk present and indicate how to reduce risk of injury, damage and electric shock resulting from

improper use of the appliance. Please observe the following instructions:

- The appliance must be disconnected from the power supply before carrying out any installation work.
- Installation and maintenance must be carried out by a qualified technician, in compliance with the manufacturer’s instructions and local safety regulations. Do not repair or replace any part of the appliance unless specifically stated in the user manual.
- Regulations require that the appliance is earthed.
- The power cable must be long enough for connecting the appliance, once fitted in its housing, to the power supply.
- For installation to comply with current safety regulations, an all-pole disconnect switch with minimum contact gap of 3 mm

- must be utilized.
- Do not use multiple plug adapters or extension leads.
- Do not pull the power cable to disconnect it from the electrical supply.
- The electrical components must not be accessible to the user after installation.
- The appliance is designed solely for household use for cooking food. No other type of use is permitted (e.g. heating rooms). The Manufacturer declines all responsibility for inappropriate use or incorrect setting of the controls.
- The appliance and its accessible parts become hot during use. Care should be taken to avoid touching heating elements. Children less than 8 years of age shall be kept away unless continuously supervised. This appliance can be used by children aged from 8 years and above and persons with reduced physical, sensory or mental capabilities or lack of experience and knowledge if they have been given supervision or instruction concerning use of the appliance in a safe way and understand the hazards involved. They shall not play with the appliance. Cleaning and user maintenance shall not be made by children supervision.
- The accessible parts of the appliance may become very hot during use. Keep children away from the appliance and supervise them to ensure that they do not play with it.
- During and after use, do not touch the heating elements of the appliance. Do not allow the appliance to come into contact with cloths or other flammable materials until all the components have cooled sufficiently.
- Do not place flammable material on or near the appliance.
- Overheated oils and fats catch fire easily. Never leave the appliance unattended when cooking with fat and oil.
- Metallic objects such as knives, forks, spoons and lids should not be placed on the hob surface since they can get hot.
- A separator panel (not supplied) must be installed in the space under the appliance

at a distance at least 20mm. If an Ikea separator is used, follow the instructions given in the panel reference material. No separator is needed if an oven is installed underneath.

- If you don't install the oven underneath, you must use the separator and between the separator and the cabinet you must install the drawer.
- If the surface is cracked, switch off the appliance to avoid the possibility of electric shock.
- The appliance is not intended to be operated by means of an external timer or separate remote control system.

- Do not use steam cleaners.
- Unattended cooking on a hob with fat or oil can be dangerous and may result in fire. NEVER try to extinguish a fire with water, but switch off the appliance and then cover flame e.g. with a lid or a fire blanket.
Danger of fire: do not store items on the cooking surfaces.
- After use, switch off the hob element by its control and do not rely on the pan detector.
- The instructions for hobs incorporating halogen lamps shall warn the user not to stare at the hob elements.

Product description

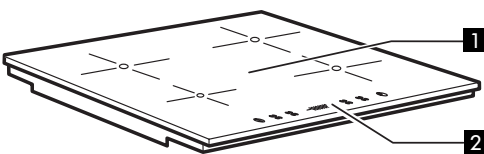

- 1** Induction cooking zone
- 2** Control panel

Control panel

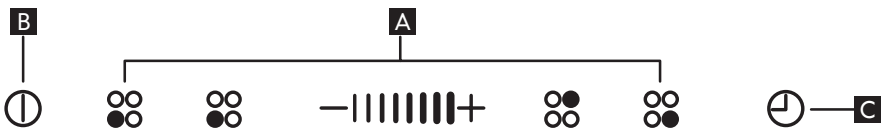

- A** Cooking zone controls and corresponding display
- B** On/Off

- C** Timer/Child lock/Power Management

Daily use

Switching the hob ON/OFF

To switch the hob on, press the  button for approx. 2 seconds until the cooking zone displays light up. To switch off, press the same button until the displays switch off. All the cooking zones are deactivated.

If the hob has been in use, the residual heat indicator “H” remains lit until the cooking zones have cooled down.

If within 10 seconds of switching on, no function is selected, the hob switches off automatically.

Before use

Important: The induction cooking zones will not switch on if pots and pans are not of the correct dimensions.

Only use pots bearing the symbol “INDUCTION SYSTEM”.

Before switching the hob on, position the pot on the desired cooking zone.

Existing pots and pans:

Use a magnet to check whether pots or pans are suitable for use on the induction hob: pots are unsuitable if they cannot be magnetically detected.

1. Ensure pots have a smooth bottom, otherwise they may scratch the hob's glass ceramic surface. Check dishes.
2. Do not use empty pots on the hob. This could result in damage to both the glass ceramic surface and the bottom of the pots.
3. Never place hot pots or pans on the hob's control panel. This could result in damage.

Switching on and adjusting cooking zones



Power indicator display

Selected cooking zone indication



Cooking zone positioning

Once the hob is switched on and the pan is positioned on the chosen cooking zone, select the zone using the corresponding button: the display shows level 0.

With the Slider it is possible to select the required power level, from min. 0 to max. 9, or booster “P”. To increase the power level, slide your finger on the slider from left to right several times; to decrease it, slide in the opposite direction. Alternatively the “+” and “-” quick access buttons can be used.

Each cooking zone has various power levels, adjustable with the +/- buttons, going from “1”: min. power, to “9”: max. power. Some cooking zones have a fast boil function (Booster), shown on the display with the letter “P”.

Fast boil function (Booster)

This function, only present on some cooking zones, makes it possible to exploit the hob's maximum power (for example to bring water to the boil very quickly). To activate the function, press the “+” button until “P” appears on the display. After 5 minutes' use of the booster function, the appliance automatically sets the zone to level 9.

Demo Mode

This hob is equipped with a demo mode which allows you to interact with the control panel without activating the corresponding cooking zones.

The activation and deactivation procedure must be carried out within 60 seconds of the

appliance being connected to the power supply in the home.

To activate the demo mode, hold the two external cooking zone selection buttons at the same time for at least 5 seconds: “dE” appears on the central display. You can now explore the control panel functions.

To deactivate Demo mode, repeat the procedure, remembering first of all to disconnect the hob from the mains and then reconnect it, carrying out the procedure within 60 seconds of connection.

Activation/deactivation of the acoustic signal

After switching on the hob, keep the “+” button and outermost selection button on the right (“control panel lock”) pressed at the same time for at least 3 seconds

Deactivation of cooking zones

Select the cooking zone you wish to switch off. Press the corresponding button (a dot lights up at the bottom right of the power level indicator).

Press the key “-” to set the level to “0”.

To switch off instantly, hold the zone selection button for 3 seconds. The cooking zone switches off and the residual heat indicator “H” lights up.

Control panel lock

This function locks the controls to prevent accidental switching on of the hob.

To activate the control panel lock function, hold button C for 3 seconds.

The control panel is locked except for the deactivation function. To deactivate the control panel lock, repeat the activation procedure.

The luminous dot goes off and the hob is active again.

The presence of water, liquid spilled from pots or any objects resting on the button below the symbol can accidentally activate or deactivate the control panel lock function.

Slider



The timer can be used to set cooking time for a maximum of 99 minutes (1 hour and 39 minutes) for all cooking zones.

Select the cooking zone to be used with the timer (an illuminated dot appears to the bottom right hand side of the heat setting indicator on the display), press the button with the clock symbol then set the desired cooking time using the buttons “+” and “-” of the timer function (see figure).

After a few seconds, the timer begins the countdown (an illuminated dot is visible next to the zone for which the timer has been activated).

Once the set time has elapsed, an acoustic signal sounds and the cooking zone switches off automatically.

To deactivate the timer, press the “-” button until the display shows “0:0”.

To set the timer for another zone, repeat the points above. The timer display always shows the timer for the selected zone or the shortest timer.

To change or switch off the timer, press the zone selection button for the timer in question.

Control panel warnings

Residual heat indicator.

The hob is fitted with a residual heat indicator for each cooking zone. These indicators alert the user when cooking zones are still hot.

If the display shows H, the cooking zone is still hot. If the residual heat indicator of a given cooking zone is lit, that zone can be used, for example, to keep a dish warm or to melt butter.

When the cooking zone cools down, the display goes off.

Incorrect or missing pot indicator.

If you are using a pot that is not suitable, not correctly positioned or not of the correct dimensions for your induction hob, the message “no pot” will appear in the display (see figure). If no pot is detected within 60 seconds, the hob switches off.



Power management

Thanks to the “Power management” function, the user can set the maximum power the hob can reach, as required. This setting is possible at any time and is maintained until the next change.

By setting the required maximum power, the hob automatically adjusts distribution in the various cooking zones, ensuring that this limit is never exceeded; with the advantage of also being able to manage all the zones simultaneously, but without overload problems.

4 maximum power levels are available and showed on display: 2.5 – 4.0 – 6.0 – 7.2 kW (7.2 kW is considered as max power of cooktop) At the time of purchase, the hob is set to maximum power After plugging the appliance into the electrical socket, in the first 60 seconds it is possible to set the required power level by running the following points:

Step	Control panel	Display
1	Press for approximately 3 seconds + button	The display shows 
2	Press the Power Management (button C) to confirm the previous step	The display shows last level set previously
3	Press - + button to set the chosen level amongst the different options available	The display shows the set level.
4	Press the Power Management (button C) to confirm the previous step	The display shows the set level which flashes for approximately 2 seconds; after which the hob emits an acoustic signal and then turns itself off; it is now ready for use

In case of an error when setting the

power, the symbol  appears in the middle and an acoustic signal sounds for about 5 seconds. In this case repeat the configuration procedure from the beginning. If the error occurs again, contact the Authorized Service Centre.

During normal use, if the user tries to increase the maximum available power level when reached, the level of the zone in use flashes twice and an acoustic signal sounds.

To obtain a higher power in that zone, it is necessary to manually decrease the power level of one or more already active cooking zones.

Recommended pot bottom widths

Ø Zone	Ø Pot
210 mm	150 - 210 mm
180 mm	120 - 180 mm
145 mm	100 - 145 mm

Maintenance and cleaning

Clean the hob after each use in order to avoid damaging the surface and to prevent the formation of baked-on deposits which are difficult to remove. Before cleaning, make sure the cooking zones are switched off and that the residual heat indicator ("H") is not displayed.

 Steam cleaner is not to be used! Periodically check for dust under the appliance, near the cooling air inlet or the outlet openings.

This could hinder the ventilation and cooling of the electronic module and decrease the effectiveness of the hob.

To clean the hob, proceed as follows:

1. use a soft clean cloth, absorbent kitchen wipes or a proprietary cleaner for glass

ceramic hobs. Do not use abrasive sponges and/or metal scouring pads.

2. Food spills should be cleaned off before they bake onto the glass ceramic surface. Sugar and foods with a high sugar content damage the glass ceramic surface and must be immediately removed using a scraper for glass. Caution! Glass scrapers have a very sharp blade and must be handled with care.
3. Remove any stubborn food residues with a scraper or proprietary detergents.
4. Salt, sugar and sand can scratch the glass ceramic hob: clean up any such spills on the hob immediately.

What to do if ...

Error code	Problem	Possible cause	Solution
The hob switches off and after 10 seconds emits an acoustic signal every 3 seconds	Continuous pressure on control panel area	Water or utensils on control panel	Clean the control panel
C81, C82	The control panel switches off because of excessively high temperatures	The internal temperature of electronic parts is too high	Wait for the hob to cool down before using it again
C83	The control panel indicates the error code hob off because of an issue on electronic circuit	Cooktop has been supplied with over voltage	Cooktop may be still used but call the Authorized Service Centre
C85	Hob is not able to give power to the pot	Pot is not suitable to the induction hob	Use another induction pot
F02 or F04 or C84	The connection voltage is wrong or issue to the power supply	The sensor detects a discrepancy between the appliance voltage and that of the mains supply	Disconnect the hob from the mains and check the electrical connection
F42 or F43	The connection voltage is wrong	The sensor detects a discrepancy between the appliance voltage and that of the mains supply	Disconnect the hob from the mains and check the electrical connection
F01, F05, F06, F07, F10, F12, F25, F33, F34, F36, F37, F46, F47, F48, F49, F58, F61, F62, F63, F72, F74, F77	Call the Authorized Service Centre and specify the error code		

Before calling the Authorized Service Centre:

1. Check “Troubleshooting guide” to see if you can eliminate the problem yourself
2. Turn the hob on again to check if correct operation has been restored.
3. If the problem persists, contact the Authorized Service Centre.

Give the following information:

- type of fault;
- hob model;
- service number (i.e. the number after the word SERVICE on the dataplate under the hob and on the warranty certificate);

SERVICE 0000 000 00000



- your full address;
- your telephone number.

If any repairs are required, contact an authorised service centre, indicated in the warranty.

In the unlikely event that an operation or repair is carried out by an unauthorised technician, always request certification of the work carried out and insist on the use of original spare parts.

Failure to comply with these instructions may compromise the safety and quality of the product.

Technical data

Dimensions	
Width (mm)	580
Height (mm)	58
Depth (mm)	510
Voltage (V)	See Installation and electrical connection

The technical information are situated in the rating plate on the bottom side of the appliance.

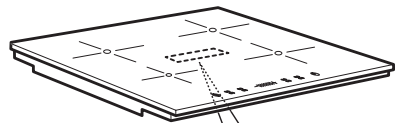

Electrical connection

⚠ WARNING. Disconnect the appliance from the power supply.

- Installation must be carried out by qualified personnel who know the current safety and installation regulations.
- The manufacturer declines all liability for injury to persons or animals and for damage to property resulting from failure to observe the regulations provided in this chapter.
- The power cable must be long enough to allow the hob to be removed from the worktop.
- Make sure the voltage specified on the dataplate located on the bottom of the appliance is the same as that of the home.

For each connection to the network, the hob automatically checks for a few seconds.

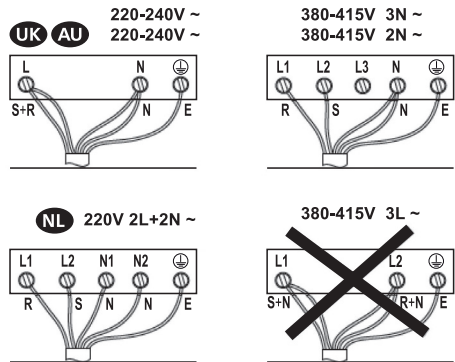
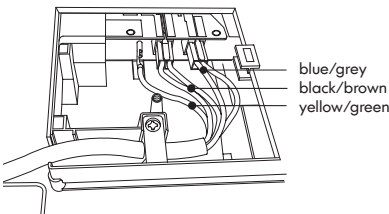
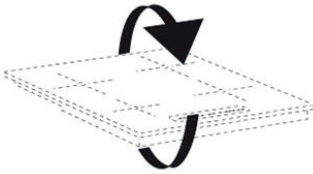
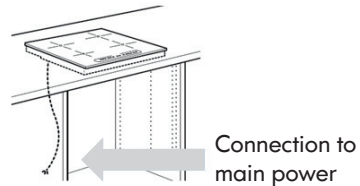
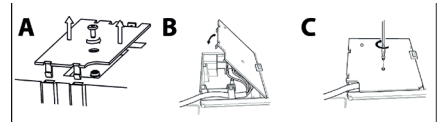

- = E (yellow-green)
- N1 = N (blue)
- N2 = N (blue)
- L1 = R (black)
- L2 = S (brown)

1. Remove the terminal cover (A) by unscrewing the screw and insert the cover into the hinge (B) of the terminal.
2. Plug the power cord into the clamp and connect the wires to the terminal block as shown in the wiring diagram located near the terminal.
3. Secure the power cable with the cable clamp.
4. Close the cover (C) and screw on the terminal with the screw removed.

Electrical connection for Australia

Power Cord and Plug: Declared Article – Mandatory Approval Applies:
Current Australian Approval Certificates will need to be forwarded, showing compliance with applicable Australian Standards, as noted below. Plug to have insulated pins. Plug and Cord to have approval marking, as required by the relevant Approval Certificate

- AS/NZS 3112: 2004 with Amendment 1, for Plug
- AS 3191: 2008, for Cord, or;
- 'HAR' Certification, for Cord

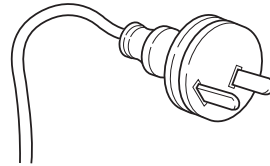
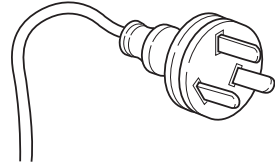

Environmental concerns

Disposal of packaging materials

The packaging material is entirely recyclable and marked with the recycling symbol (♻️). Do not dispose of the various packaging materials carelessly, but do so responsibly and in full compliance with local authority regulations governing waste disposal.

Scrapping

This appliance is marked in compliance with European Directive 2012/19/EU on Waste Electrical and Electronic Equipment (WEEE). By ensuring that this appliance is scrapped suitably, you can help prevent potentially damaging consequences for the environment and health.



The symbol  on the appliance or accompanying documentation indicates that this product should not be disposed of as unsorted municipal waste but must be taken to a collection point for the treatment of WEEE.

Energy saving

For optimum results, observe the following advice:

- Use pots and pans whose bottom diameter is equal to that of the cooking zone.
- Only use flat-bottomed pots and pans.
- If possible, keep pot lids on when cooking.
- Make sure you place the pot or pan in the centre of the cooking zone outlined on the hob.

Declaration of Conformity

- This appliance has been designed, constructed and marketed in compliance with the safety requirements of "Low Voltage" Directive 2006/95/EC (replacing 73/23/EEC as amended) and protection requirements of "EMC" Directive 2004/108/EC.
- This appliance meets the eco design requirements of european regulations n. 66/2014, in conformity to the european standard en 60350-2.

IKEA GUARANTEE

How long is the IKEA guarantee valid?

This guarantee is valid for five (5) years from the original date of purchase of your appliance at IKEA Pty Ltd, ABN 84 006 270 757 or at Cebas Pty Ltd, ABN 15 009 156 003, unless the appliance is named LAGAN in which case two (2) years of guarantee apply.

The original sales receipt, is required as proof of purchase.

If service work is carried out under guarantee, this will not extend the guarantee period for the appliance.

Which appliances are not covered by the IKEA five (5) years guarantee?

The range of appliances named LAGAN .

Who will execute the service?

IKEA has appointed Whirlpool (Australia) Pty Ltd as the authorised service network partner.

- If you encounter any trouble with the appliance and wish to register a call with Whirlpool, please call:

Australia contact centre:

1300 363 344.

Or use the Contact Us form at the website: www.whirlpool.com.au

The principal address and contact details in Australia are:

www.IKEA.com.au or

- For Queensland, New South Wales and Victorian customers please contact:

IKEA Pty Ltd

IKEA Service Office
L1 Clock Tower, 630 Princes Highway
Tempe, NSW 2044

Victoria:	(03) 8523 2154
New South Wales:	(02) 8020 6641
Queensland:	(07) 3380 6800
IKEA Perth:	(08) 9201 4532
IKEA Adelaide:	(08) 8154 4532

- For Western Australian and South Australian customers please contact:

Cebas Pty Ltd

8c Sunray Drive,
Innaloo WA 6018 Australian

IKEA Perth: (08) 9201 4532

IKEA Adelaide: (08) 8154 4532

For after sales service, contact Whirlpool (Australia) on 1300 363 344.

Or use the Contact Us form at the website: www.whirlpool.com.au.

What does this guarantee cover?

The guarantee covers applicable faults of the appliance, which have been caused by faulty construction or material faults from the date of purchase from IKEA.

This guarantee applies to domestic use only. The products have been designed and tested for domestic purposes only and this guarantee does not cover damage arising from use of the Product in a commercial environment.

The exceptions are specified under the headline "What is not covered under this guarantee?" Within the guarantee period, the costs to remedy the fault e.g. repairs, parts, labour and travel will be covered, provided that the appliance is accessible for repair without special expenditure. Replaced parts become the property of IKEA.

The guarantee exists only if the appliance complies and is installed in accordance with:

- The technical specifications.
- The Assembly Instructions and user manual Safety Information.

IKEA's guarantee is subject to Australian Consumer Law - see Schedule 2 to Competition and Consumer Act, 2010.

This guarantee is in addition to (and does not exclude, restrict or modify in any way) any non-excludable statutory warranties in Australia.

What will IKEA do to correct the problem?

IKEA appointed service provider will

examine the product and decide, at its sole discretion, if it is covered under this guarantee. If considered covered, IKEA service provider or its authorized service partner through its own service operations, will then, at its sole discretion, either repair the defective product or replace it with the same or a comparable product.

What is not covered under this guarantee?

- Normal wear and tear.
- Deliberate or negligent damage, damage caused by failure to observe operating and maintenance instructions, incorrect installation or by connection to the wrong voltage, damage caused by chemical or electrochemical reaction, rust, abrasion or scratching, corrosion or water damage including but not limited to damage caused by excessive lime in the water supply, damage caused by abnormal environmental conditions.
- Damage caused from the use of the appliance in a manner other than the use for which it was specifically designed.
- Damage caused by power outages, electrical power surge or improper supply voltage via connection to Supply Authority mains or alternative supply systems.
- Consumable parts including batteries and lamps, removable wire, glass and plastic trays and other accessories.
- Internal or external damage as a result of excessive use of cleaning products or cleaning agents.
- Non-functional and decorative parts which do not affect normal use of the appliance, including any scratches and possible color differences.
- Accidental damage or blockages caused by foreign objects, eg. coins, underwires, nails, buttons or jewellery, or substances and cleaning or unblocking of filters, drainage systems or soap drawers
- Damage caused by vermin, insects or pets.
- Note – internal or external cabinet transport damage must be reported within 7 days of purchase date.
- Damage to the following parts: ceramic glass, accessories, crockery and cutlery baskets, feed and drainage pipes, seals, lamps and lamp covers, screens, knobs, casings and parts of casings. Unless such damages can be proved to have been caused by production faults.
- Cases where no fault could be found during a technician's visit.
- Any consequential loss due to appliance failure.
- Repairs not carried out by our appointed service providers and/or an authorized service contractual partner or where non original parts have been used.
- Repairs to parts or systems caused by unauthorized modifications made to appliance.
- Repairs caused by installation which is faulty or not according to specification.
- Problems caused by incorrect or inadequate venting of the appliance.
- The use of the appliance in a non domestic environment i.e. professional use.
- Transportation damages. If a customer transports the product to his home or another address, IKEA is not liable for any damage that may occur during transport. However, if IKEA delivers the product to the customer's delivery address, then damage to the product that occurs during this delivery will be covered by IKEA.
- Cost for carrying out the initial installation of the IKEA appliance. However, if an IKEA appointed Authorized Service Centre or its authorized service partner repairs or replaces the appliance under the terms of this guarantee, the Authorized Service Centre or its authorized service partner will reinstall the repaired appliance or install the replacement, if necessary.
- The benefits conferred by this express warranty are in addition to all other

conditions, warranties, guarantees, rights and remedies expressed or implied by the Trade Practices Act and similar State and Territory laws and all other obligations and liabilities on the part of the manufacturer or supplier and nothing contained herein shall restrict or modify such rights, remedies, obligations or liabilities.

How country law applies?

Our goods come with guarantees that cannot be excluded under the Australian Consumer Law (ACL).

You are entitled to a replacement or refund for a major failure and for compensation for any other reasonably foreseeable loss or damage.

You are also entitled to have the goods repaired or replaced if the goods fail to be of acceptable quality and the failure does not amount to a major failure.

This guarantee is not intended in any way to limit or exclude such rights and remedies that you may have under law.

You can find out more information about the Australian Consumer Law on the ACCC website: www.accc.gov.au

Area of validity

The IKEA guarantee applies only to products purchased and installed in AUSTRALIA .

What you must do to make a claim under the guarantee

To make a claim under the guarantee contact IKEA Authorized Service Centre at the above address, the IKEA catalogue or refer to www.ikea.com.au for your local store customer service phone number, online email and opening times. Please describe the problem that you are facing with the appliance in detail along with your product article number **(8 digit code) and date of purchase at the time of call registration.**

Please do not hesitate to contact the dedicated Authorized Service Centre for IKEA appliances to:

1. Make a service request under this guarantee.
2. Ask for clarification on installation of the IKEA appliance in the dedicated IKEA kitchen furniture.
3. Ask for clarification on user manual contents and specifications of the IKEA appliance.

To ensure that we provide you with the best assistance, please read carefully the Assembly Instructions and/or the User Manual section of this booklet before contacting us.

How to reach if you need our service

The Whirlpool call centre team will assist you on the phone with basic trouble shooting for your appliance at the time of warranty call registration.



1300 363 344

Or use the Contact Us form at the website:
www.whirlpool.com.au

Please describe the problem that you are facing with the appliance in detail along with your product model number, serial number, date of purchase at the time of call registration.

Please also always refer to the IKEA article number (8 digit code) and 12 digit service number placed on the rating plate of your appliance.



SAVE THE SALES RECEIPT!

Kindly keep all these details and original invoice of purchase handy during the service technician's visit to enable him to carry out the job. It is your proof of purchase and required for the guarantee to apply.

400010813090

