

# STRÅLA

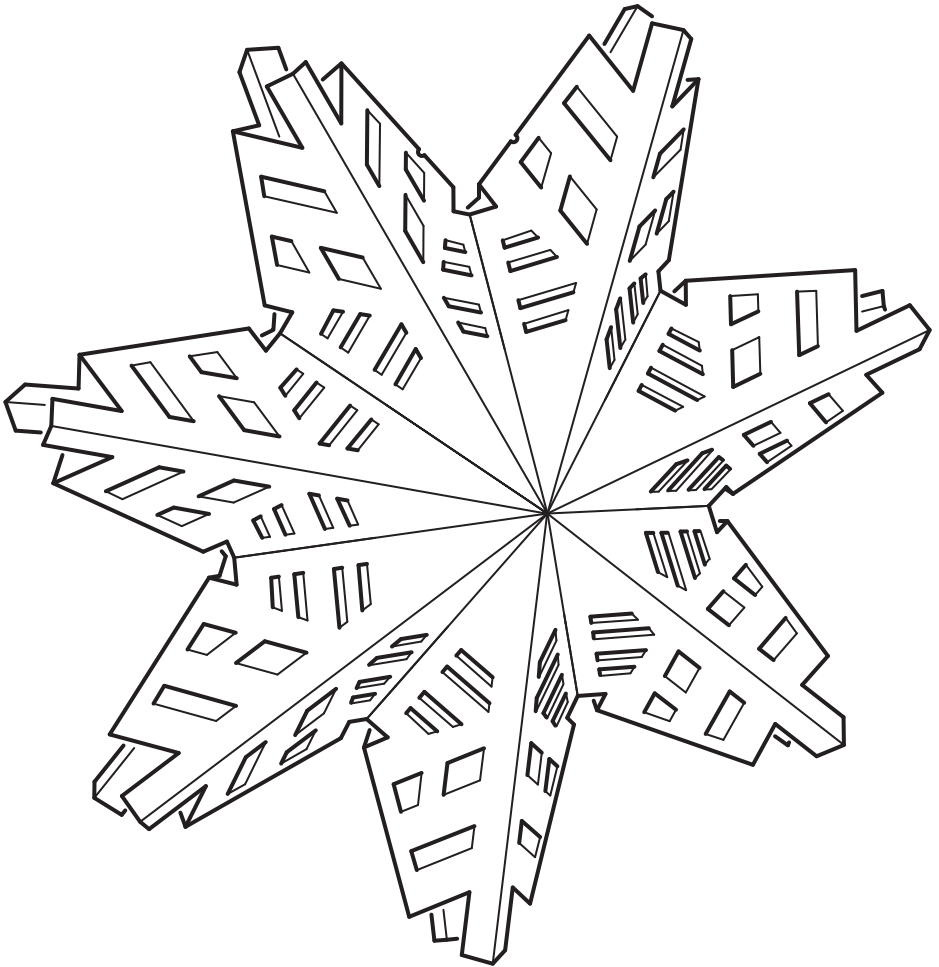

Design and Quality  
IKEA of Sweden



### English

The distance between surface of bulb and shade must be at least 30 mm.

### Deutsch

Der Abstand zwischen der Lichtquelle und dem Schirm muss mindestens 30 mm betragen.

### Français

La distance séparant l'ampoule de l'abat-jour doit être d'au moins 30 mm.

### Nederlands

De afstand tussen lamp en lampenkap moet minstens 30 mm bedragen.

### Dansk

Afstanden mellem pærens overflade og lampeskærmen skal være mindst 30 mm.

### Íslenska

Fjarlægðin á milli perunnar og skermisins verður að vera a.m.k. 30 mm.

### Norsk

Avstanden mellom overflaten på ei pære og skjermen må være minst 3 cm.

### Suomi

Etäisyyden lampun pinnan ja varjostimen välillä täytyy olla vähintään 30 mm.

### Svenska

Avståndet mellan ljuskälla och skärm måste vara minst 30 mm.

### Česky

Vzdálenost mezi žárovkou a stínidlem musí činit nejméně 30 mm.

### Español

La distancia entre la bombilla y la pantalla debe ser de 30 mm como mínimo.

### Italiano

La distanza tra la superficie della lampadina e quella del paralume deve essere di almeno 30 mm.

### Magyar

Az izzó felülete és a lámpaernyő közötti távolság legalább 30 mm legyen.

### Polski

Odległość pomiędzy powierzchnią żarówki a kloszem musi wynosić co najmniej 30 mm.

### Eesti

Lambipirni pinna ja kupli kaugus teineteisest peab olema vähemalt 30 mm.

### Latviešu

Attālums starp spuldzes virsmu un lampas abažūru jābūt vismaz 30 mm.

### Lietuvių

Atstumas nuo lemputės (paviršiaus) iki gaubto turi būti mažiausiai 30 mm.

### Portugues

A distância entre a superfície da lâmpada e o abajur deve ser de cerca de 30 mm.

### Română

Distanța dintre bec și abajur trebuie să fie de cel puțin 30mm.

### Slovensky

Vzdialenosť medzi povrchom žiarovky a tienidlom musí byť aspoň 30 mm.



### Български

Разстоянието между повърхността на крушката и абажура трябва да бъде поне 30 мм.

### Hrvatski

Udaljenost između površine žarulje i sjenila mora biti barem 30 mm.

### Ελληνικά

Η απόσταση μεταξύ της επιφάνειας του λαμπτήρα και του καπέλου πρέπει να είναι τουλάχιστον 30 mm.

### Русский

Расстояние от поверхности лампы до абажура должно быть не меньше 30 мм.

### Українська

Відстань між поверхнею лампи та абажуром повинна бути більшою, ніж 30 мм.

### Srpski

Razmak između sijalice i abažura mora biti najmanje 30 mm.

### Slovenščina

Razdalja med površino žarnice in senčnikom mora biti najmanj 30 mm.

### Türkçe

Ampul ve abajur arasındaki mesafe en az 30 mm olmalıdır.

### 中文

灯泡表面与灯罩之间需保持至少30毫米的距离。

### 繁体

燈泡表面與燈罩之間須保持至少3公分的距離。

### 한국어

전구와 전등갓은 최소 30mm의 간격을 두어야 합니다.

### 日本語

電球表面とシェードの間の距離は30mm以上必要です。

### Bahasa Indonesia

Jarak antara permukaan bohlam dan kap setidaknya harus 30 mm.

### Bahasa Malaysia

Jarak antara permukaan mentol dan terendak seharusnya pada sekurang-kuangnya 30 mm.

عربي  
يجب أن تكون المسافة بين سطح اللبنة والغطاء 30 ملم على الأقل.

### ไทย

หลอดไฟและโคมควรมีระยะห่างจากกันอย่างน้อย 30 มม.

### Tiếng Việt

Khoảng cách tối thiểu giữa bề mặt bóng đèn và chụp đèn phải là 30 mm.

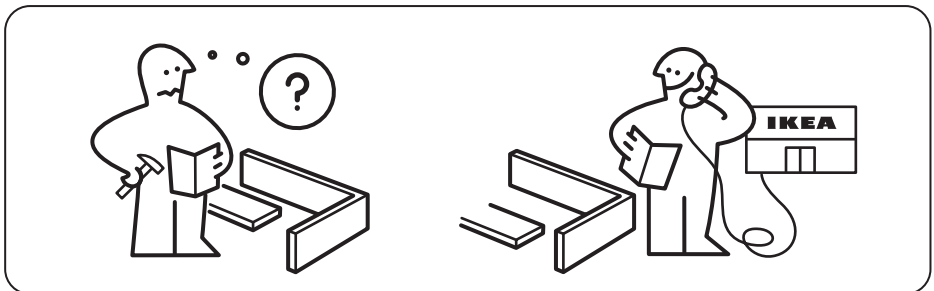

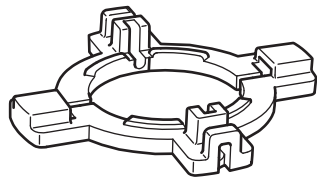
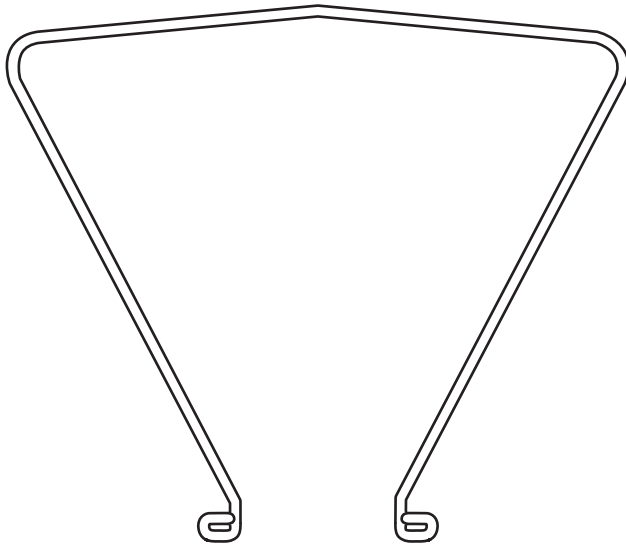
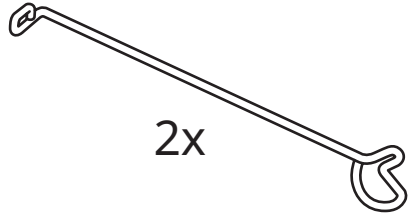

1

i

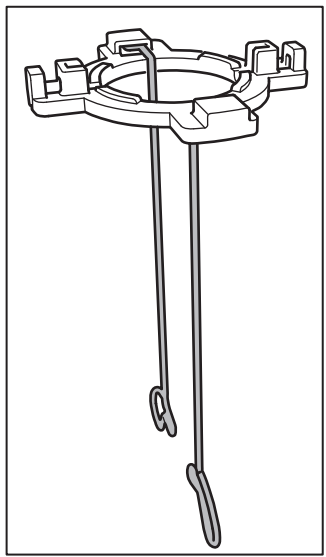
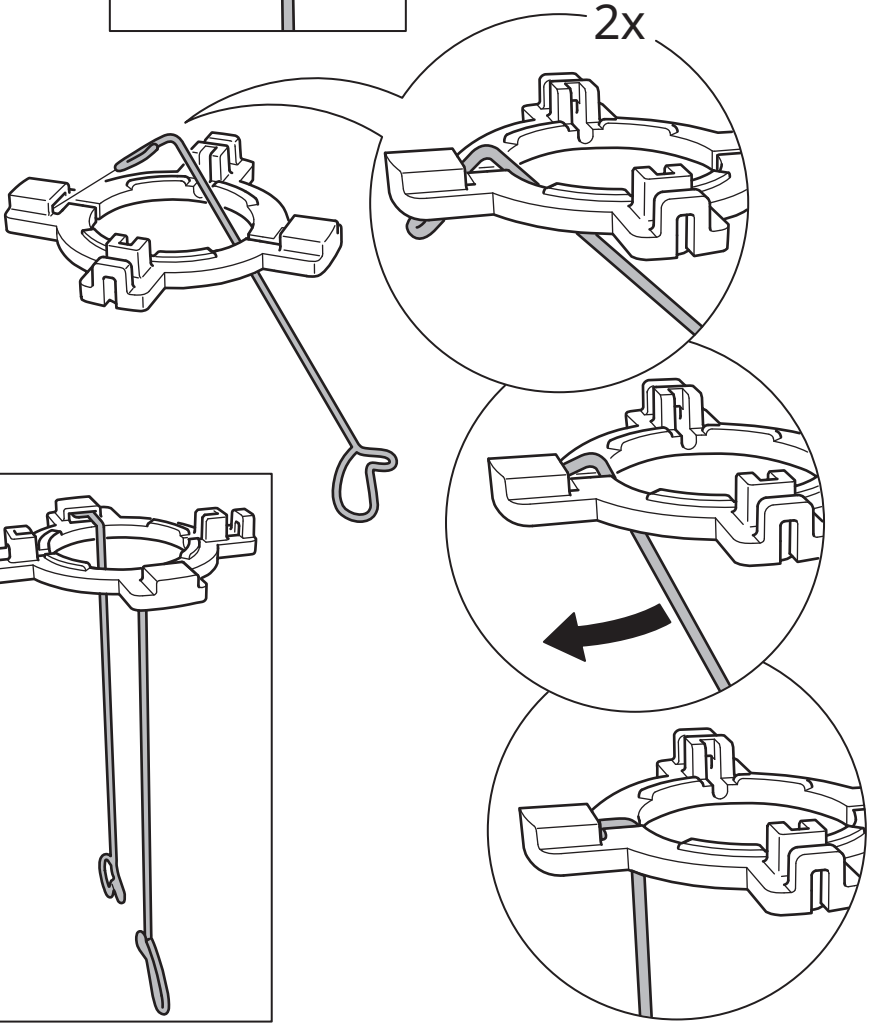
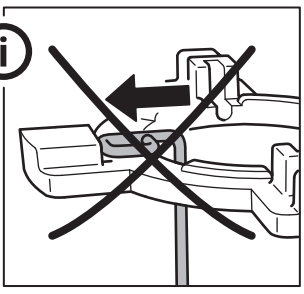

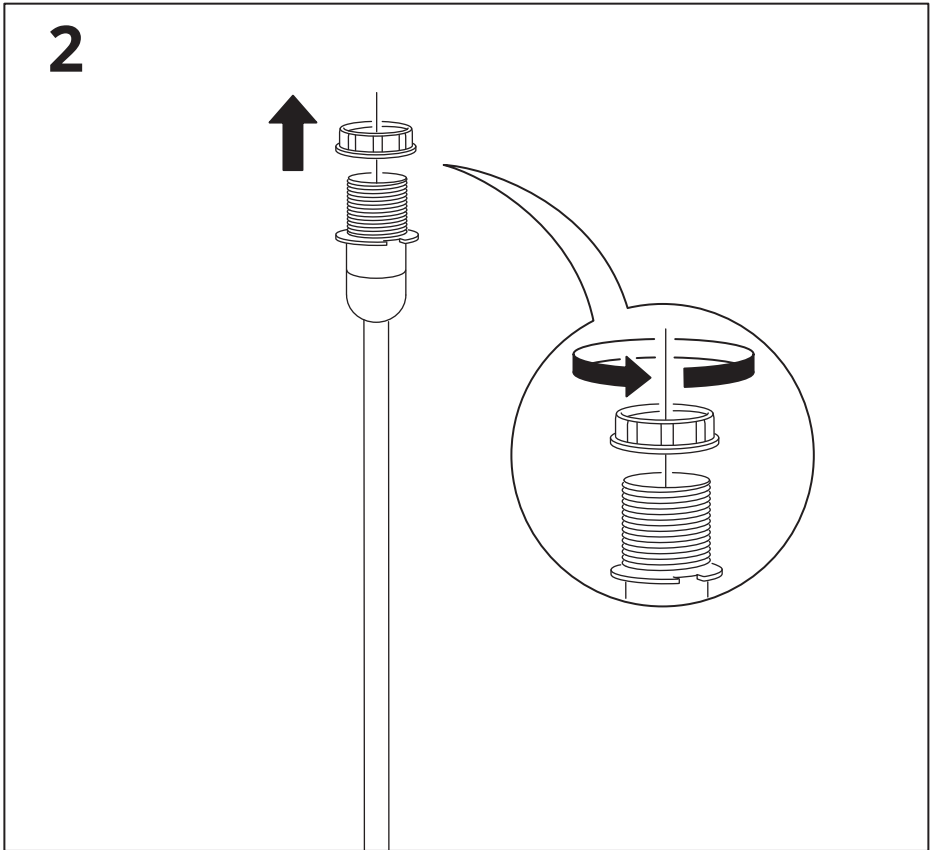
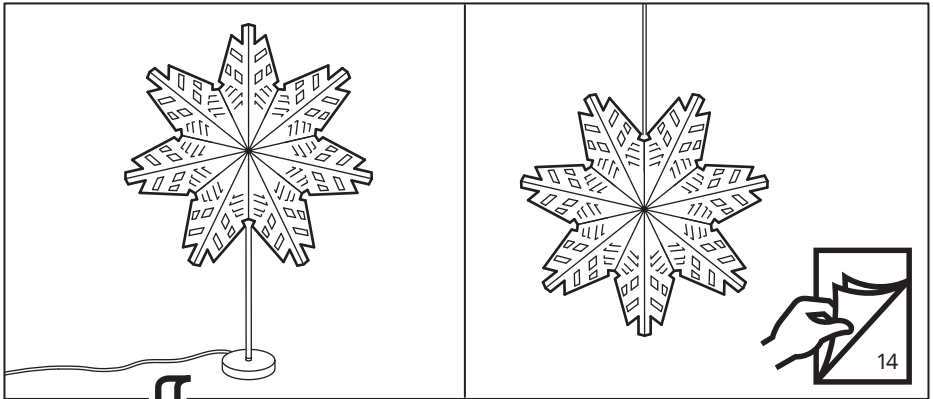

3

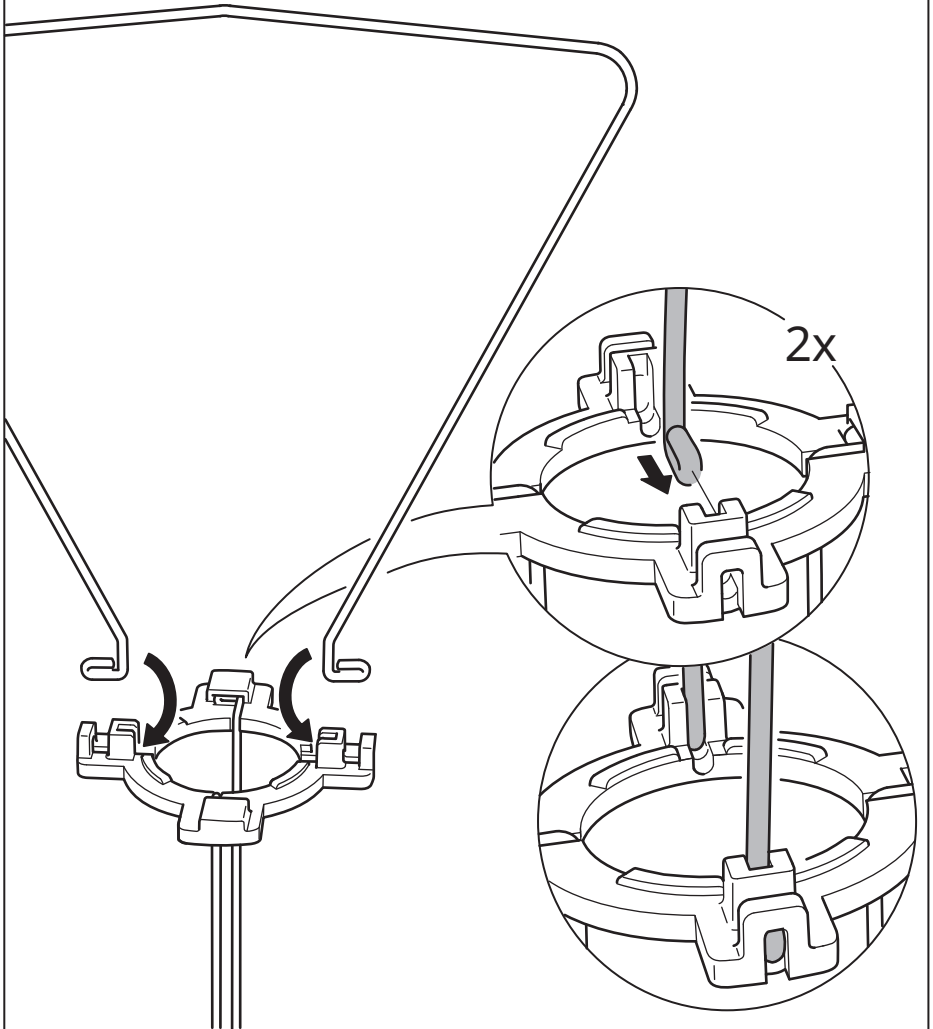

4

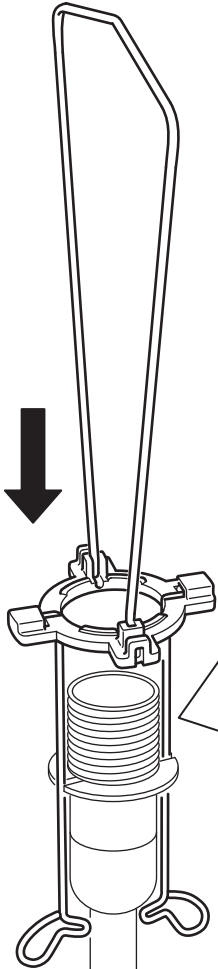

i

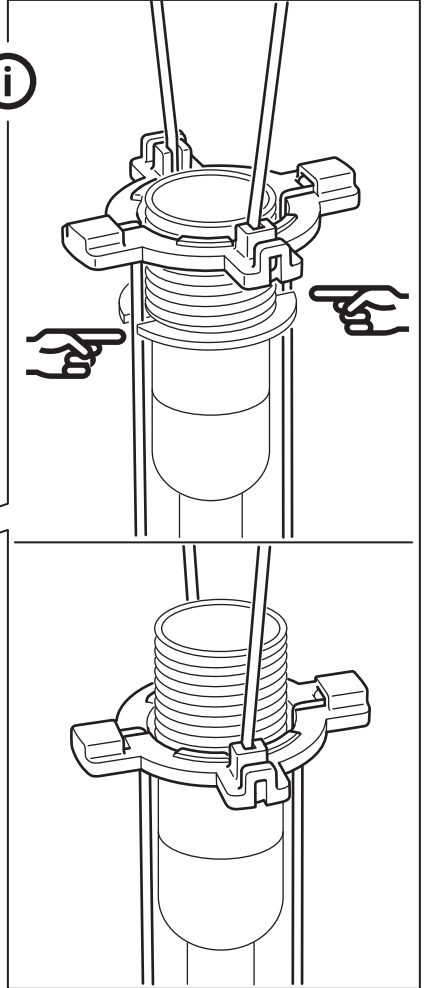



5

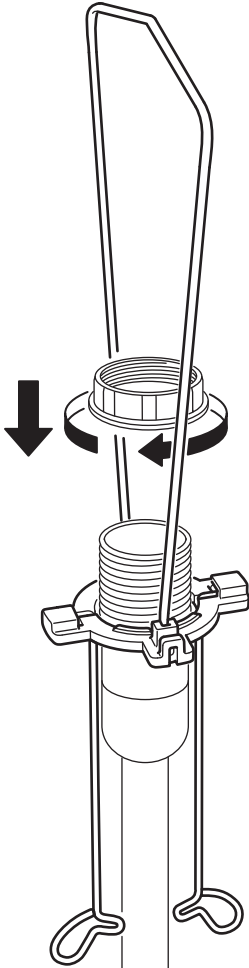

6

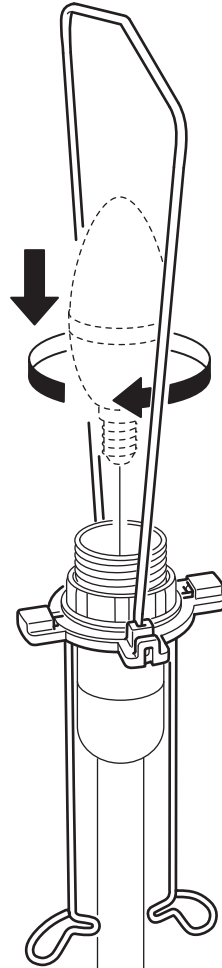

7

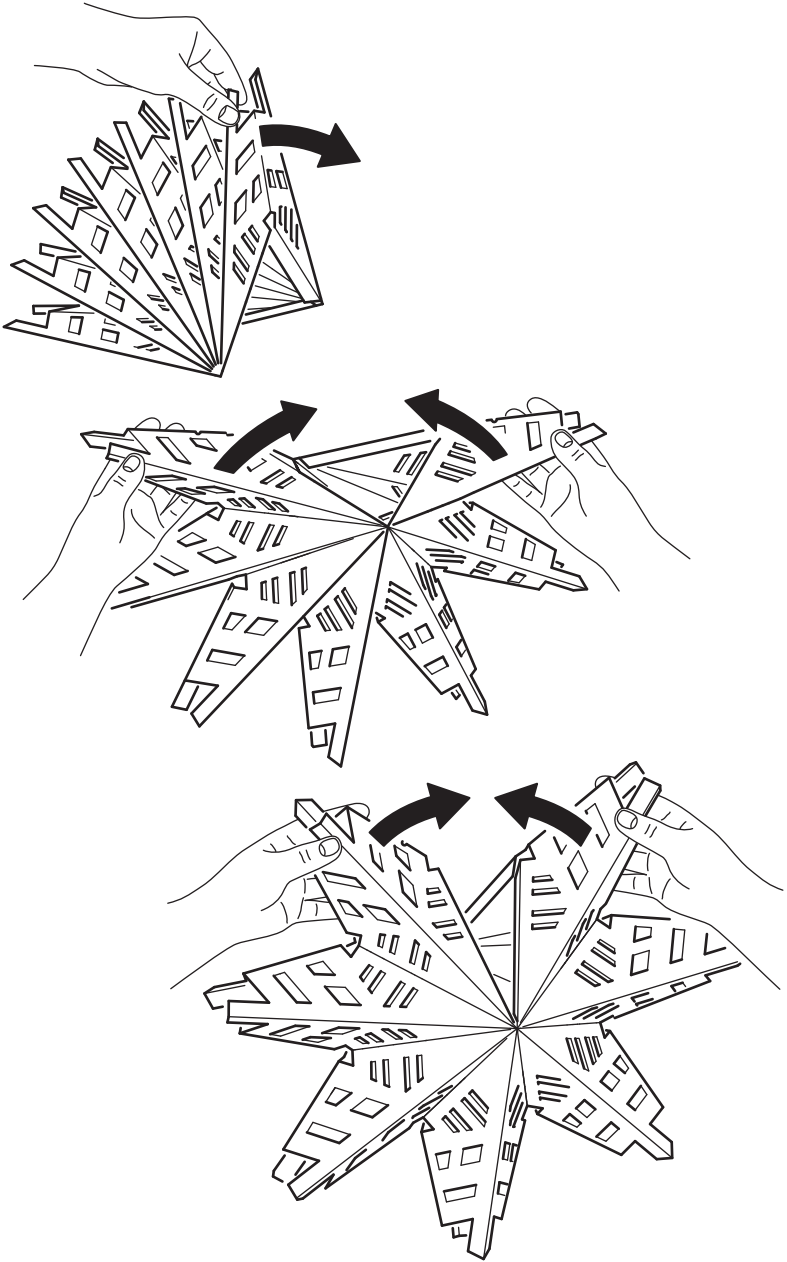

8

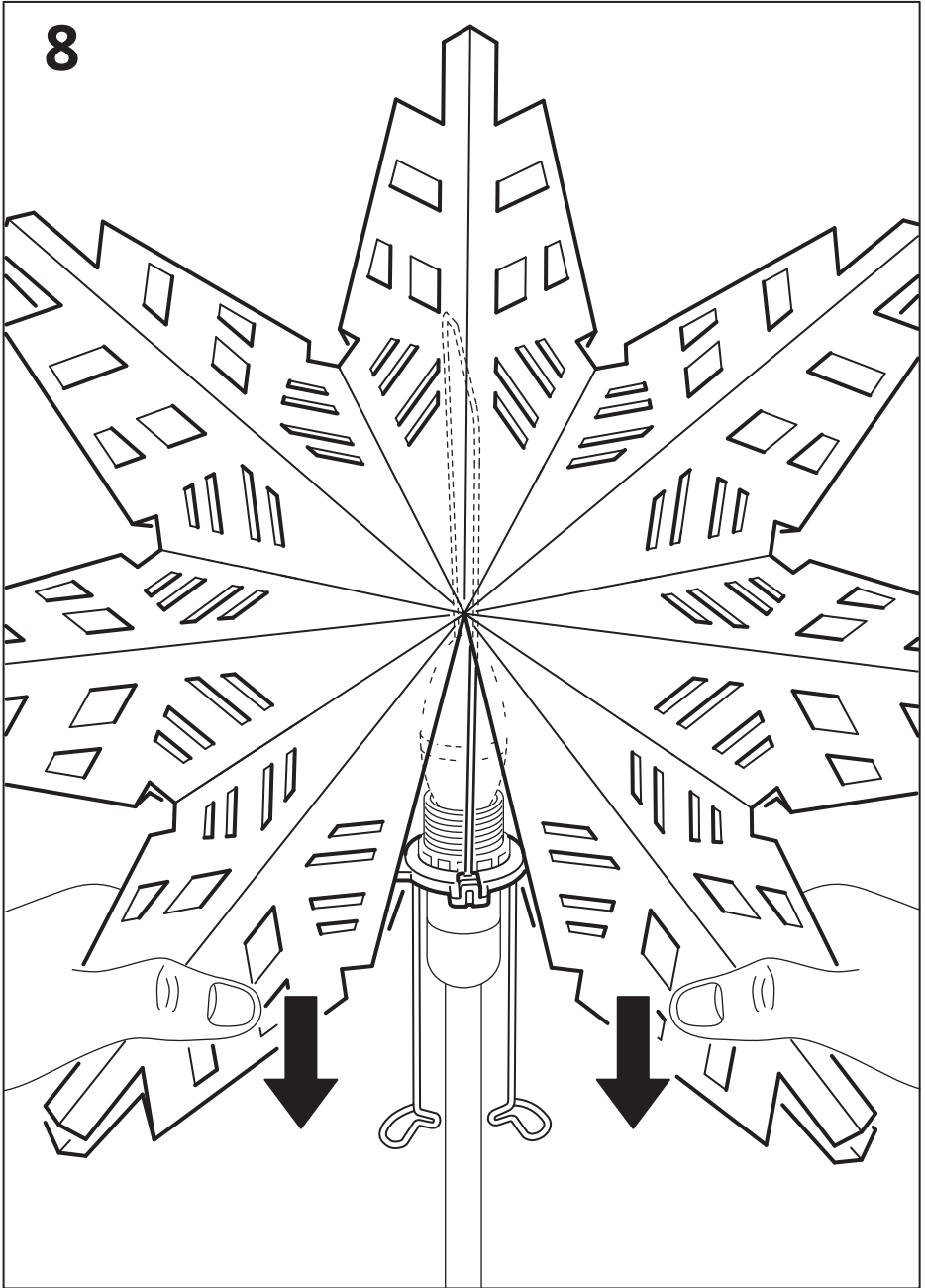

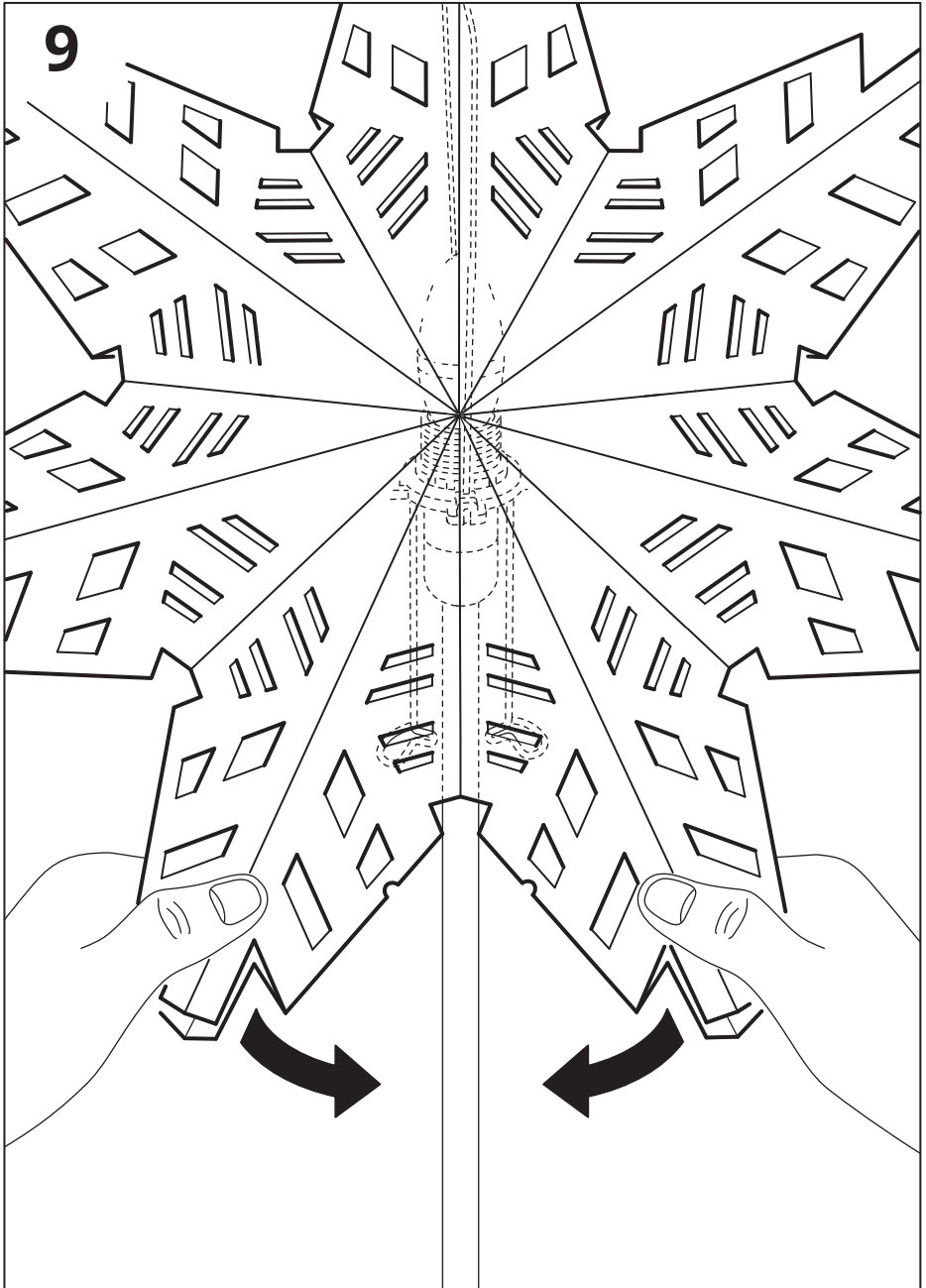

10

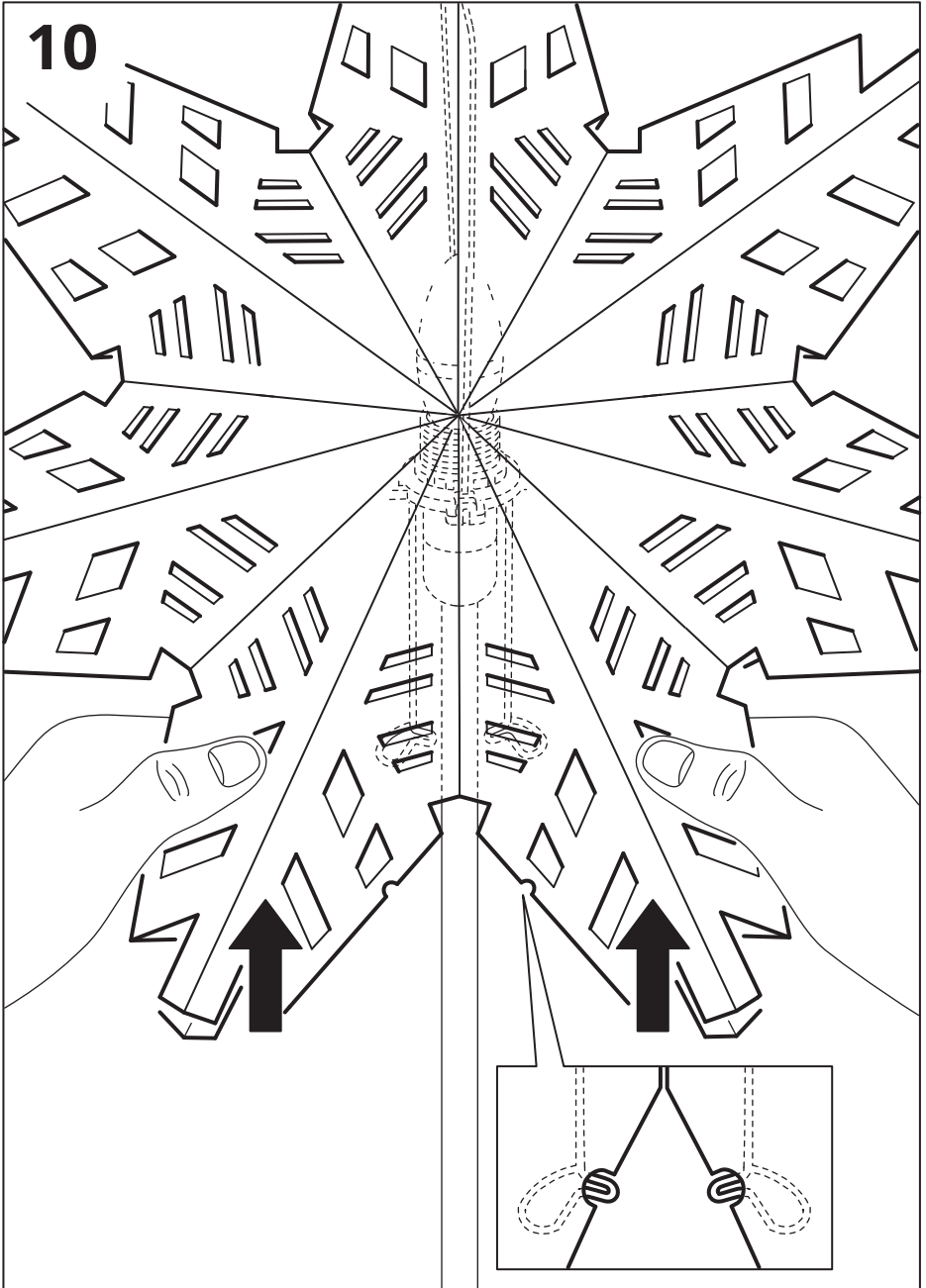

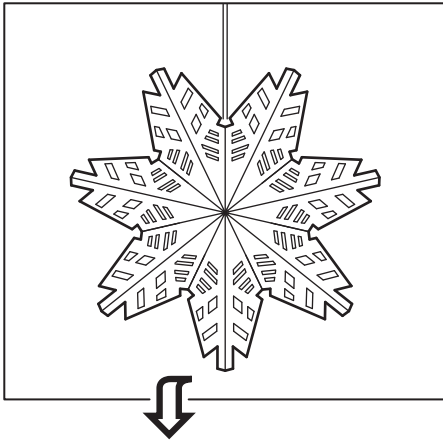

2

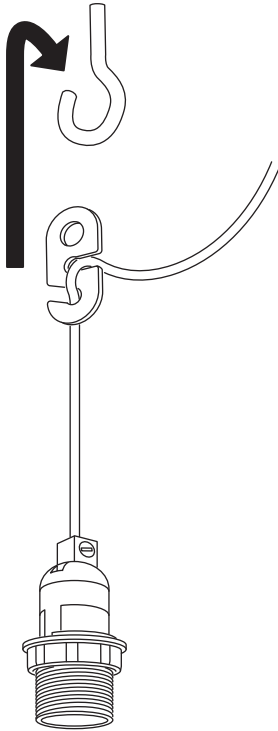

3

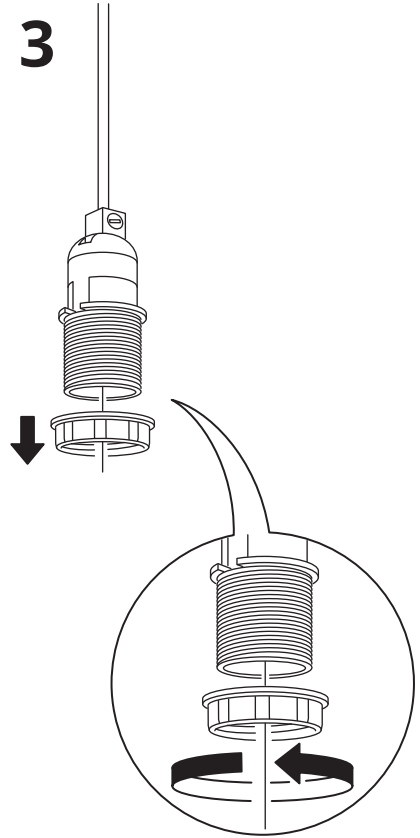

4

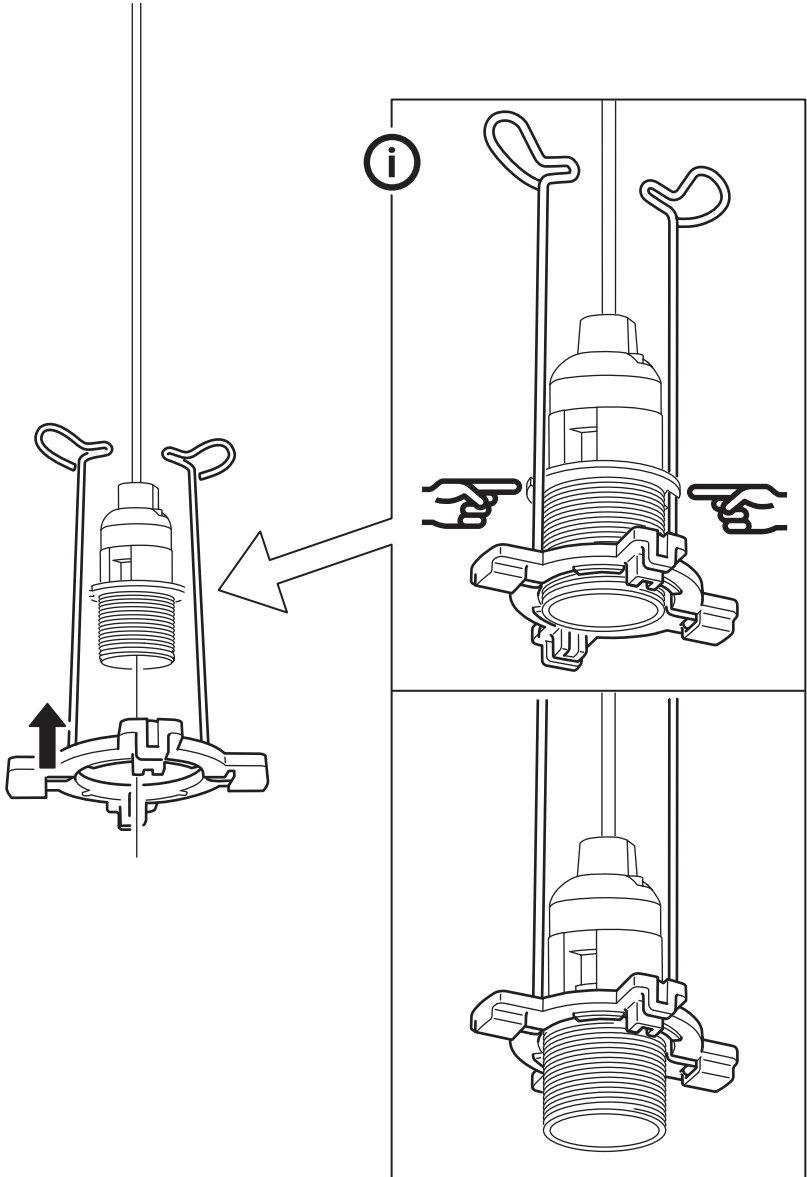

5

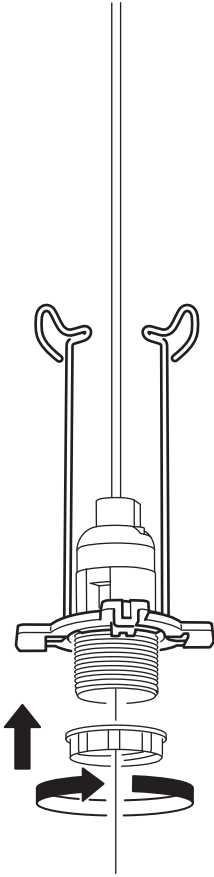

6

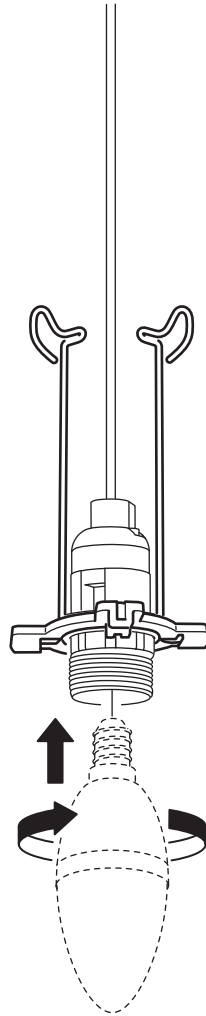



7

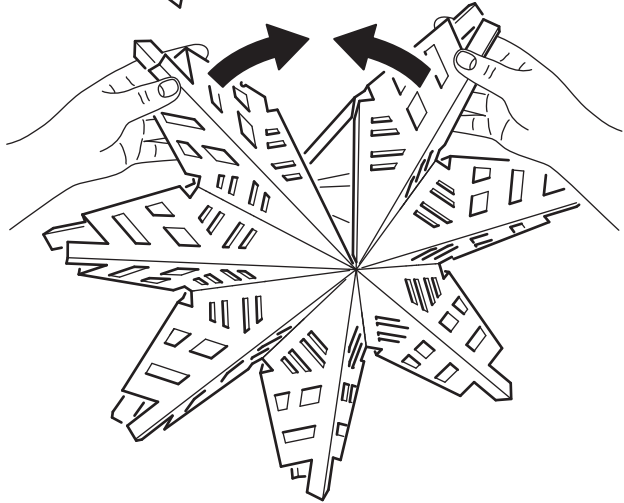
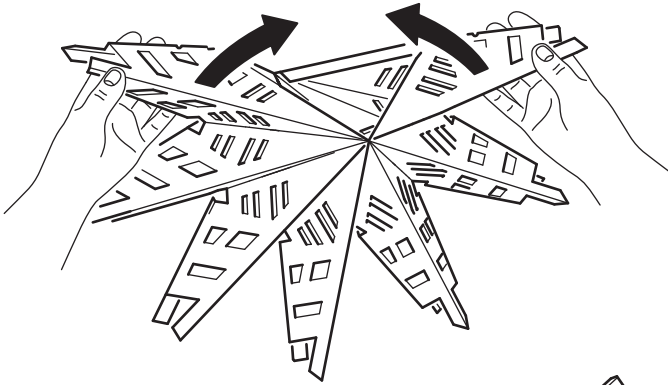
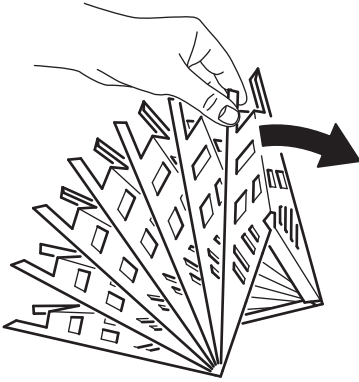

8

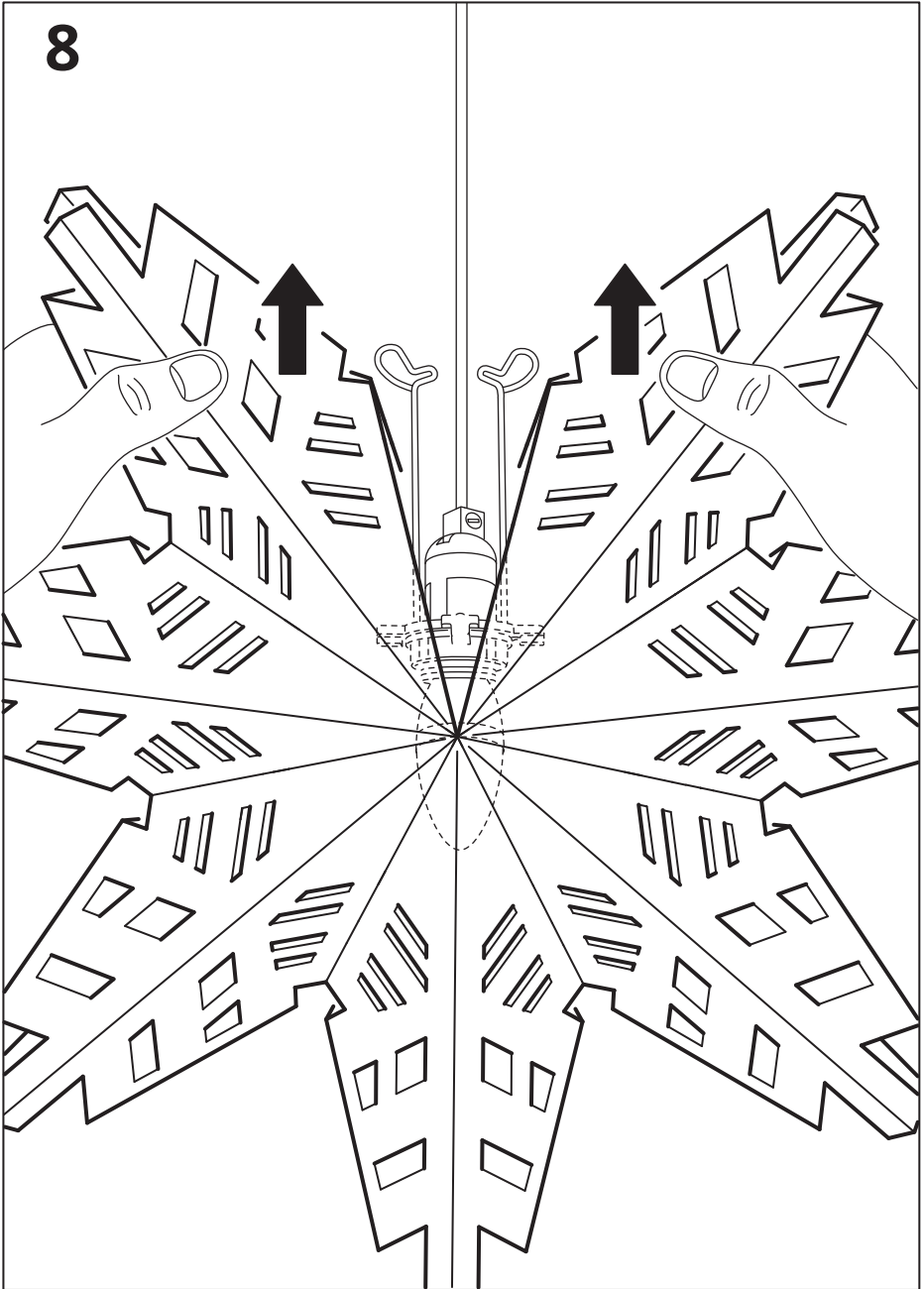

9

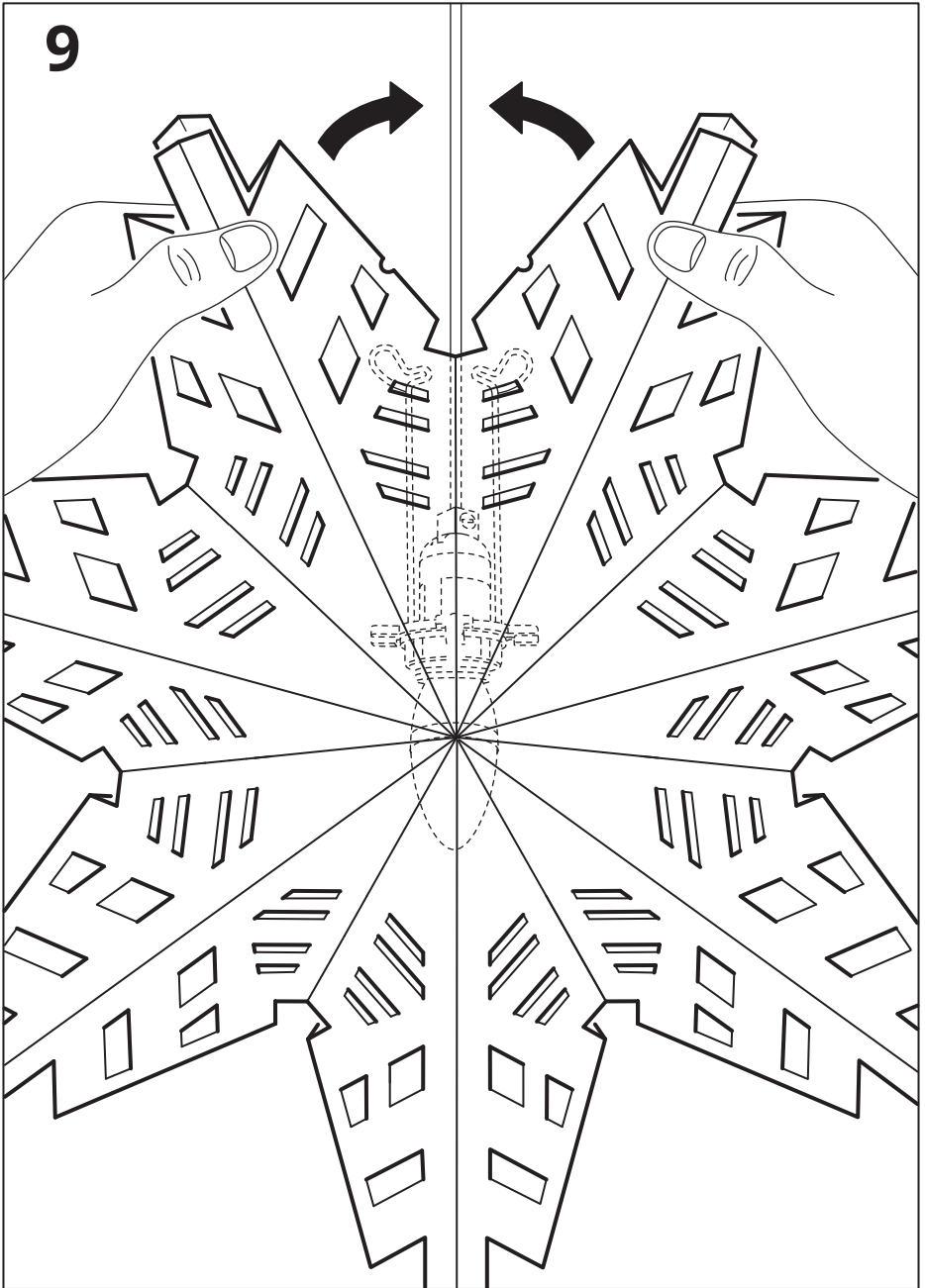

10

