

KULINARISK

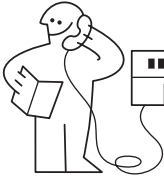



ENGLISH

Please refer to the last page of this manual for the full list of IKEA appointed After Sales Service Provider and relative national phone numbers.

ENGLISH

4

Contents

Safety information	4	Additional functions	20
Safety instructions	6	Hints and tips	22
Installation	9	Care and cleaning	26
Product description	10	Troubleshooting	29
Control panel	10	Technical data	31
Before first use	12	Energy efficiency	31
Daily use	13	Environmental concerns	32
Clock functions	17	IKEA guarantee	33
Automatic programmes	18		
Using the accessories	18		

Subject to change without notice.

Safety information

Before the installation and use of the appliance, carefully read the supplied instructions. The manufacturer is not responsible if an incorrect installation and use causes injuries and damage. Always keep the instructions with the appliance for future reference.

Children and vulnerable people safety

- This appliance can be used by children aged from 8 years and above and persons with reduced physical, sensory or mental capabilities or lack of experience and knowledge if they have been given supervision or instruction concerning the use of the appliance in a safe way and understand the hazards involved.
- Children between 3 and 8 years of age and persons with very extensive and complex disabilities shall be kept away from the appliance unless continuously supervised.
- Children of less than 3 years of age should be kept away from the appliance unless continuously supervised.
- Do not let children play with the appliance.
- Keep all packaging away from children and dispose of it appropriately.

- Keep children and pets away from the appliance when it operates or when it cools down. Accessible parts may become hot during use.
- If the appliance has a child safety device, it should be activated.
- Children shall not carry out cleaning and user maintenance of the appliance without supervision.

General Safety

- Only a qualified person must install this appliance and replace the cable.
- **WARNING:** The appliance and its accessible parts become hot during use. Care should be taken to avoid touching heating elements.
- Always use oven gloves to remove or put in accessories or ovenware.
- Before any maintenance, cut the power supply.
- **WARNING:** Ensure that the appliance is switched off before replacing the lamp to avoid the possibility of electric shock.
- Do not use the appliance before installing it in the built-in structure.
- Do not use a steam cleaner to clean the appliance.
- Do not use harsh abrasive cleaners or sharp metal scrapers to clean the glass door since they can scratch the surface, which may result in shattering of the glass.
- If the mains power supply cable is damaged, it must be replaced by the manufacturer, its Authorised Service Centre or similarly qualified persons to avoid an electrical hazard.
- Excessive spillage must be removed before the pyrolytic cleaning. Remove all parts from the oven.
- To remove the shelf supports first pull the front of the shelf support and then the rear end away from the side walls. Install the shelf supports in the opposite sequence.

- Use only the food sensor (core temperature sensor) recommended for this appliance.

Safety instructions

Installation

⚠ Warning! Only a qualified person must install this appliance.

- Remove all the packaging.
- Do not install or use a damaged appliance.
- Follow the installation instructions supplied with the appliance.
- Always take care when moving the appliance as it is heavy. Always use safety gloves and enclosed footwear.
- Do not pull the appliance by the handle.
- Install the appliance in a safe and suitable place that meets installation requirements.
- Keep the minimum distance from other appliances and units.
- Before mounting the appliance, check if the oven door opens without restraint.

Cabinet minimum height (Cabinet under the worktop minimum height)	580 (600) mm
Cabinet width	560 mm
Cabinet depth	550 (550) mm
Height of the front of the appliance	589 mm
Height of the back of the appliance	571 mm
Width of the front of the appliance	595 mm
Width of the back of the appliance	559 mm
Depth of the appliance	569 mm

Built in depth of the appliance	548 mm
Depth with open door	1022 mm
Ventilation opening minimum size. Opening placed on the bottom rear side	560x20 mm
Mains supply cable length. Cable is placed in the right corner of the back side	1500 mm
Mounting screws	2x25 mm

Electrical connection

⚠ Warning! Risk of fire and electric shock.

- All electrical connections should be made by a qualified electrician.
- The appliance must be earthed.
- Make sure that the parameters on the rating plate are compatible with the electrical ratings of the mains power supply.
- Always use a correctly installed shockproof socket.
- Do not use multi-plug adapters and extension cables.
- Make sure not to cause damage to the mains plug and to the mains cable. Should the mains cable need to be replaced, this must be carried out by our Authorised Service Centre.
- Do not let mains cables touch or come near the appliance door or the niche below the appliance, especially when it operates or the door is hot.

- The shock protection of live and insulated parts must be fastened in such a way that it cannot be removed without tools.
- Connect the mains plug to the mains socket only at the end of the installation. Make sure that there is access to the mains plug after the installation.
- If the mains socket is loose, do not connect the mains plug.
- Do not pull the mains cable to disconnect the appliance. Always pull the mains plug.
- Use only correct isolation devices: line protecting cut-outs, fuses (screw type fuses removed from the holder), earth leakage trips and contactors.
- The electrical installation must have an isolation device which lets you disconnect the appliance from the mains at all poles. The isolation device must have a contact opening width of minimum 3 mm.
- Fully close the appliance door before you connect the mains plug to the mains socket.
- Do not put flammable products or items that are wet with flammable products in, near or on the appliance.



Warning! Risk of damage to the appliance.

- To prevent damage or discoloration to the enamel:
 - do not put ovenware or other objects in the appliance directly on the bottom.
 - do not put aluminium foil directly on the bottom of cavity of the appliance.
 - do not put water directly into the hot appliance.
 - do not keep moist dishes and food in the appliance after you finish the cooking.
 - be careful when you remove or install the accessories.
- Discoloration of the enamel or stainless steel has no effect on the performance of the appliance.
- Use a deep pan for moist cakes. Fruit juices cause stains that can be permanent.
- This appliance is for cooking purposes only. It must not be used for other purposes, for example room heating.
- Always cook with the oven door closed.
- If the appliance is installed behind a furniture panel (e.g. a door) make sure the door is never closed when the appliance is in operation. Heat and moisture can build up behind a closed furniture panel and cause subsequent damage to the appliance, the housing unit or the floor. Do not close the furniture panel until the appliance has cooled down completely after use.

Use



Warning! Risk of injury, burns and electric shock or explosion.

- This appliance is for household use only.
- Do not change the specification of this appliance.
- Make sure that the ventilation openings are not blocked.
- Do not let the appliance stay unattended during operation.
- Deactivate the appliance after each use.
- Be careful when you open the appliance door while the appliance is in operation. Hot air can release.
- Do not operate the appliance with wet hands or when it has contact with water.
- Do not apply pressure on the open door.
- Do not use the appliance as a work surface or as a storage surface.
- Open the appliance door carefully. The use of ingredients with alcohol can cause a mixture of alcohol and air.
- Do not let sparks or open flames to come in contact with the appliance when you open the door.

Care and Cleaning



Warning! Risk of injury, fire, or damage to the appliance.

- Before maintenance, deactivate the appliance and disconnect the mains plug from the mains socket.
- Make sure the appliance is cold. There is a risk that the glass panels can break.

- Replace immediately the door glass panels when they are damaged. Contact the Authorised Service Centre.
- Be careful when you remove the door from the appliance. The door is heavy!
- Clean regularly the appliance to prevent the deterioration of the surface material.
- Fat and food remaining in the appliance can cause fire.
- If you use an oven spray, obey the safety instructions on the packaging.

Pyrolytic cleaning



Risk of fire and burns.

- Before carrying out a Pyrolytic self-cleaning function or the First Use please remove from the oven cavity:
 - any excess food residues, oil or grease spills / deposits.
 - any removable objects (including shelves, side rails etc. provided with the product) particularly any non-stick pots, pans, trays, utensils etc.
- Read carefully all the instructions for Pyrolytic cleaning.
- Keep children away from the appliance while the Pyrolytic cleaning is in operation.
The appliance becomes very hot and hot air is released from the front cooling vents.
- Pyrolytic cleaning is a high temperature operation that can release fumes from cooking residues and construction materials, as such consumers are strongly advised to:
 - provide good ventilation during and after each Pyrolytic cleaning.
 - provide good ventilation during and after the first use at maximum temperature operation.
- Unlike all humans, some birds and reptiles can be extremely sensitive to potential fumes emitted during the cleaning process of all Pyrolytic Ovens.
 - Remove any pets (especially birds) from the vicinity of the appliance location during and after the Pyrolytic

cleaning and first use maximum temperature operation to a well ventilated area.

- Small pets can also be highly sensitive to the localized temperature changes in the vicinity of all Pyrolytic Ovens when the Pyrolytic self cleaning program is in operation.
- Non-stick surfaces on pots, pans, trays, utensils etc., can be damaged by the high temperature Pyrolytic cleaning operation of all Pyrolytic Ovens and can be also a source for low level harmful fumes.
- Fumes released from all Pyrolytic Ovens / Cooking Residues as described are not harmful to humans, including infants or persons with medical conditions.

Internal lighting



Warning! Risk of electric shock.

- Concerning the lamp(s) inside this product and spare part lamps sold separately: These lamps are intended to withstand extreme physical conditions in household appliances, such as temperature, vibration, humidity, or are intended to signal information about the operational status of the appliance. They are not intended to be used in other applications and are not suitable for household room illumination.
- Use only lamps with the same specifications.

Service

- To repair the appliance contact the Authorised Service Centre.
- Use original spare parts only.

Disposal



Warning! Risk of injury or suffocation.

- Disconnect the appliance from the mains supply.
- Cut off the mains electrical cable close to the appliance and dispose of it.

- Remove the door to prevent children and pets to get closed in the appliance.
- **Packaging material:**
The packaging material is recyclable. Plastic parts are marked with international abbreviations such as PE,

PS, etc. Dispose of the packaging material in the containers provided for this purpose at your local waste management facility.

Installation

 **Warning!** Refer to Safety chapters.

Assembly

 Refer to the Assembly Instructions for the installation.

Electrical installation

 **Warning!** Only a qualified person must do the electrical installation.

 The manufacturer is not responsible if you do not follow the safety precautions from the Safety chapters.

This oven is only supplied with a main cable.

Cable

Cable types applicable for installation or replacement:

H07 RN-F, H05 RN-F, H05 RRF, H05 VV-F, H05 V2V2-F (T90), H05 BB-F

For the section of the cable refer to the total power on the rating plate. You can also refer to the table:

Total power (W)	Section of the cable (mm ²)
maximum 1380	3 x 0.75
maximum 2300	3 x 1
maximum 3680	3 x 1.5

The earth cord (green / yellow cable) must be 2 cm longer than phase and neutral cables (blue and brown cables).

Product description

General overview

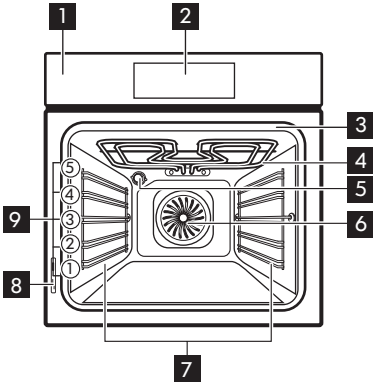

- 1 Control panel
- 2 Electronic programmer
- 3 Socket for the core temperature sensor
- 4 Grill
- 5 Lamp
- 6 Fan
- 7 Shelf support, removable
- 8 Rating plate
- 9 Shelf positions

Accessories

- **Wire shelf** x 2
For cookware, cake tins, roasts.
- **Baking tray** x 1
For cakes and biscuits.
- **Grill- / Roasting pan** x 1







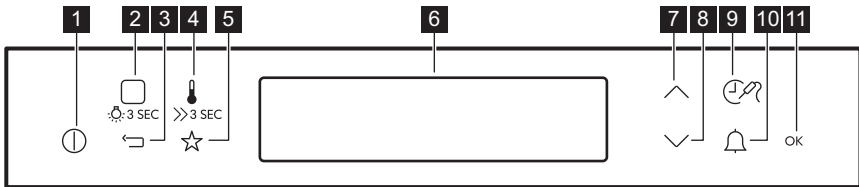

- To bake and roast or as pan to collect fat.
- **Core temperature sensor** x 1
To measure how far the food is cooked.
- **Telescopic runners** x 2 sets
For shelves and trays.

Control panel

Electronic programmer



	Symbol	Function	Comment
1		ON / OFF	To turn on and off the oven.





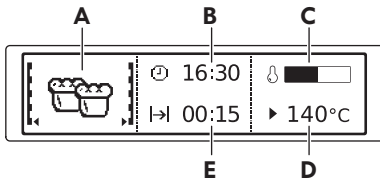





	Symbol	Function	Comment
2		Heating Functions or Assisted Cooking	Press once to enter to the Heating Functions Menu. Press again to switch to Assisted Cooking. To turn on or off the light, press  for 3 seconds.
3		Back key	To go back one level in the menu. To show the main menu, press the symbol for 3 seconds.
4		Temperature selection	To set the temperature or show the current temperature in the oven. Press the symbol for 3 seconds to turn on or off the function: Fast Heat Up.
5		Favourites	To save and access your favourite programmes.
6	-	Display	Shows the current settings of the oven.
7		Up key	To move up in the menu.
8		Down key	To move down in the menu.
9		Time and additional functions	To set different functions. When a heating function operates, press the symbol to set the timer or the functions: Function Lock, Favourites, Heat + Hold, Set + Go. You can also change the settings of the core temperature sensor.
10		Minute Minder	To set the function: Minute Minder.
11	OK	OK	To confirm the selection or setting.

Display

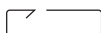

- A. Heating function
- B. Time of day
- C. Heat-up indicator
- D. Temperature
- E. Duration time or end time of a function

Other indicators of the display:

Symbol	Function	
	Minute Minder	The function works.
	Time of day	The display shows the current time.
	Duration	The display shows the necessary time for cooking.
	End Time	The display shows when the cooking time is complete.
	Temperature	The display shows the temperature.
	Time Indication	The display shows how long the heating function works. Press \vee and \wedge at the same time to reset the time.
	Calculation	The oven calculates the time for cooking.
	Heat-up Indicator	The display shows the temperature in the oven.
	Fast Heat Up	The function works. It decreases the heat up time.
	Weight Automatic	The display shows that the automatic weight system works or that weight can be changed.
	Heat + Hold	The function works.

Before first use

 **Warning!** Refer to Safety chapters.

Initial Cleaning

Remove all accessories and removable shelf supports from the oven.

Refer to "Care and cleaning" chapter.

Clean the oven and the accessories before the first use.

Put the accessories and the removable shelf supports back to their initial position.

First Connection

When you connect the oven to the mains or after the power cut, you have to set the language, the display contrast, the display brightness and the time of the day.

1. Press \wedge or \vee to set the value.
2. Press **OK** to confirm.

Preheating

Before first use preheat the oven with only wire shelves and baking trays inside.

1. Set the function: Conventional Cooking — and the maximum temperature.
2. Let the oven operate for 1 hour.
3. Set the function: True Fan Cooking (🌀) and the maximum temperature.
4. Let the oven operate for 15 minutes. Accessories can become hotter than usual. The oven can emit an odour and smoke during preheating. Make sure that the airflow in the room is sufficient.

Using the Mechanical child lock

The oven has the child lock installed. It is on the right side of the oven, below the control panel.

To open the oven door with the child lock:

1. Pull and hold the child lock handle up as shown in the picture.

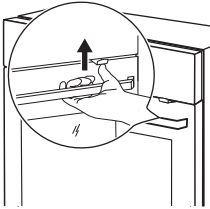

2. Open the door. Close the oven door without pulling the child lock. To remove the child lock, open the oven door and remove the child lock with the torx key. The torx key is in the oven fitting bag.

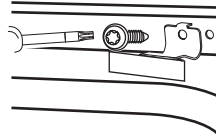

Screw back the screw into the hole after removing the child lock.

⚠ Warning! Be careful not to scratch the control panel.

Daily use



⚠ Warning! Refer to Safety chapters.





Navigating the menus

1. Turn on the oven.
 2. Press \vee or \wedge to select the menu option.
 3. Press **OK** to move to the submenu or accept the setting.
- i** At each point you can go back to the main menu with \square .



The menus in overview













Main menu

Symbol / Menu item	Application
 Heating Functions	Contains a list of heating functions.
 Recipes	Contains a list of automatic programmes. The recipes for these programmes can be found in the recipe book.

Symbol / Menu item	Application
 Favourites	Contains a list of favourite cooking programmes created by the user.
 Cleaning	Pyrolytic cleaning.
 Basic Settings	Used to set the appliance configuration.
 Specials	Contains a list of additional heating functions.
 Assisted Cooking	Contains recommended oven settings for a wide choice of dishes. Select a dish and start the cooking process. The temperature and time are only guidelines for a better result and can be adjusted. They depend on the recipes and the quality and quantity of the used ingredients.





Submenu for: Basic Settings





Symbol / Menu item	Description
 Set Time of Day	Sets the current time on the clock.
 Time Indication	When ON, the display shows the current time when you deactivate the appliance.
 Fast Heat Up	When ON, the function decreases the heat-up time.

Symbol / Menu item	Description
 Set + Go	To set a function and activate it later with a press of any symbol on the control panel.
 Heat + Hold	Keeps the prepared food warm for 30 minutes after a cooking cycle finished.
 Time Extension	Activates and deactivates the time extension function.
 Display Contrast	Adjusts the display contrast by degrees.
 Display Brightness	Adjusts the display brightness by degrees.
 Set Language	Sets the language for the display.
 Buzzer Volume	Adjusts the volume of press-tones and signals by degrees.
 Key Tones	Activates and deactivates the tone of the touch fields. It is not possible to deactivate the tone of the ON / OFF touch field.
 Alarm/Error Tones	Activates and deactivates the alarm tones.
 Cleaning Reminder	Reminds you when to clean the appliance.
 DEMO mode	For retailer use only.
 Service	Shows the software version and configuration.









Symbol / Menu item	Description
 Factory Settings	Resets all settings to factory settings.

Heating Functions

Heating function	Application
 True Fan Cooking	To bake on up to three shelf positions at the same time and to dry food. Set the temperature 20 - 40 °C lower than for Conventional Cooking.
 Conventional Cooking	To bake and roast food on one shelf position.
 Pizza Function	To bake pizza. To make intensive browning and a crispy bottom.
 Slow Cooking	To prepare tender, succulent roasts.
 Bottom Heat	To bake cakes with crispy bottom and to preserve food.

Heating function	Application
 Moist Fan Baking	This function is designed to save energy during cooking. For the cooking instructions refer to "Hints and tips" chapter, Moist Fan Baking. The oven door should be closed during cooking so that the function is not interrupted and to ensure that the oven operates with the highest energy efficiency possible. When you use this function, the temperature in the cavity may differ from the set temperature. The residual heat is used. The heating power may be reduced. For general energy saving recommendations refer to "Energy Efficiency" chapter, Energy Saving. This function was used to comply with the energy efficiency class according to EN 60350-1. When you use this function the lamp automatically turns off after 30 seconds.
 Frozen Foods	To make convenience food (e.g. french fries, potato wedges or spring rolls) crispy.
 Grill	To grill flat food and to toast bread.
 Fast Grilling	To grill flat food in large quantities and to toast bread.
 Turbo Grilling	To roast larger meat joints or poultry with bones on one shelf position. To make gratins and to brown.

Specials

Heating function	Application
 Bread Baking	To bake bread.
 Au Gratin	For dishes such as lasagna or potato gratin. To make gratins and to brown.
 Dough Proving	To rise the yeast dough before baking. When you use this function the lamp automatically turns off after 30 seconds.
 Plate Warming	To preheat plates for serving.
 Preserving	To make vegetable preserves (e.g. pickles).
 Dehydrating	To dry sliced fruit, vegetables and mushrooms.
 Keep Warm	To keep food warm.
 Defrost	To defrost food (vegetables and fruit). The defrosting time depends on the amount and size of the frozen food. When you use this function the lamp automatically turns off after 30 seconds.

Setting a heating function

1. Turn on the oven.
2. Select the menu: Heating Functions.
3. Press **OK** to confirm.
4. Select a heating function.
5. Press **OK** to confirm.
6. Set the temperature.
7. Press **OK** to confirm.

Heat-up indicator

When you turn on a heating function, the bar on the display comes on. The bar shows that the temperature increases. When temperature is reached the buzzer sounds 3 times and the bar flashes and then disappears.

Fast Heat Up

This function decreases the heat-up time.

-  Do not put food in the oven when the Fast heat up function works.

To turn on the function, hold  for 3 seconds. The heat-up indicator alternates.







This function is not available for some oven functions.

Residual heat

When you turn off the oven, the display shows the residual heat. You can use the heat to keep the food warm.

Clock functions

Clock functions table

Clock function	Application
 Minute Minder	To set a countdown (max. 2 h 30 min). This function has no effect on the operation of the oven. Use  to turn on the function. Press  or  to set the minutes and OK to start.
 Duration	To set how long the oven works (max. 23 h 59 min).
 End Time	To set the switch-off time for a heating function (max. 23 h 59 min).

If you set the time for a clock function, the time starts to count down after 5 seconds.





If you use the clock functions: Duration, End Time, the oven turns off the heating elements after 90 % of the set time. The oven uses the residual heat to continue the cooking process until the time ends (3 - 20 minutes).

Setting the clock functions



Before you use the functions: Duration, End Time, you must set a heating function and temperature first. The oven turns off automatically.
You can use the functions: Duration and End Time at the same time if you want to automatically turn on and turn off the oven on a given time later. The functions: Duration and End Time do not work when you use the core temperature sensor.

1. Set a heating function.
2. Press  again and again until the display shows the necessary clock function and the related symbol.
3. Press  or  to set the necessary time.
4. Press **OK** to confirm.
When the time ends, a signal sounds. The oven turns off. The display shows a message.
5. Press any symbol to stop the signal.

Heat + Hold

Conditions for the function:

- The set temperature is more than 80 °C.
- The function: Duration is set.

The function: Heat + Hold keeps prepared food warm at 80 °C for 30 minutes. It turns on after the baking or roasting procedure ends.

You can turn on or turn off the function in the menu: Basic Settings.



1. Turn on the oven.
2. Select the heating function.
3. Set the temperature above 80 °C.
4. Press  again and again until the display shows: Heat + Hold.
5. Press **OK** to confirm.

When the function ends, a signal sounds.

Time Extension

The function: Time Extension makes the heating function continue after the end of Duration.

- i Applicable to all heating functions with Duration or Weight Automatic.
 Not applicable to heating functions with the core temperature sensor.

1. When the cooking time ends, a signal sounds. Press any symbol. The display shows the message.
2. Press  to turn on or  to cancel.
3. Set the length of the function.
4. Press **OK**.

Automatic programmes

- ⚠ **Warning!** Refer to Safety chapters.

Recipes online

- i You can find the recipes for the automatic programmes specified for this oven on the website www.ikea.com. To find the proper Recipe Book check the article number on the rating plate on the front frame of the oven cavity.

Recipes

This oven has a set of recipes you can use. The recipes are fixed and you cannot change them.

1. Turn on the oven.
2. Select the menu: Recipes. Press **OK** to confirm.
3. Select the category and dish. Press **OK** to confirm.
4. Select a recipe. Press **OK** to confirm.

Using the accessories

- ⚠ **Warning!** Refer to Safety chapters.

Inserting the accessories

Wire shelf:

Push the shelf between the guide bars of the shelf support and make sure that the feet point down.

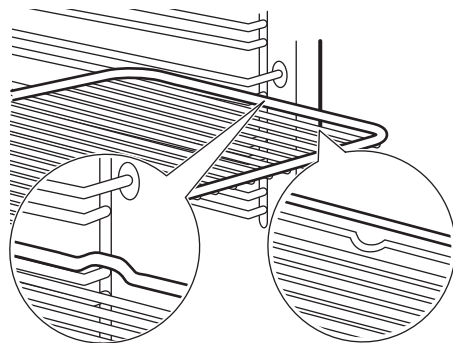

Baking tray/ Deep pan:

Push the baking tray / deep pan between the guide bars of the shelf support.

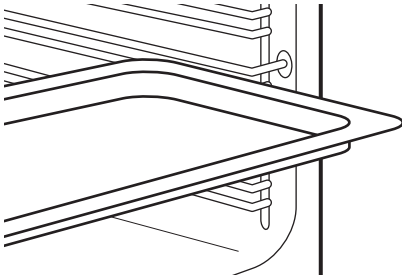

Wire shelf and baking tray / deep pan together:

Push the baking tray / deep pan between the guide bars of the shelf support and the wire shelf on the guide bars above.

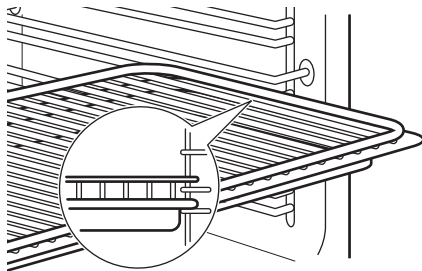

i Small indentation at the top increase safety. The indentations are also anti-tip devices. The high rim around the shelf prevents cookware from slipping of the shelf.

Core temperature sensor

There are two temperatures to be set: the oven temperature and the core temperature.

The core temperature sensor measures the core temperature of the meat. When the meat is at the set temperature, the oven turns off.

⚠ Caution! Only use the core temperature sensor supplied or the correct replacement parts.

i The core temperature sensor must stay in the meat and in the socket during the cooking.

1. Put the tip of the core temperature sensor into the centre of the meat.
2. Put the plug of the core temperature sensor into the socket at the top of the cavity.

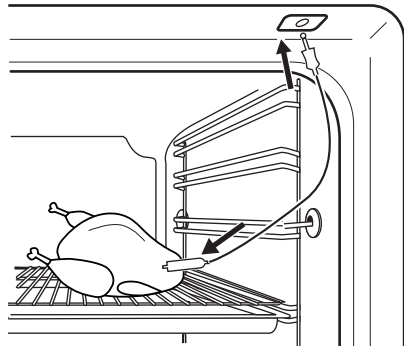

3. Turn on the oven. The display shows the core temperature sensor symbol.
4. Press \wedge or \vee in less than 5 seconds to set the core temperature.
5. Set the heating function and, if necessary, the oven temperature. The oven calculates an approximate end time. The end time is different for the different quantities of the food, the set oven temperatures (minimum 120 °C) and the operating modes. The oven calculates the end time in approximately 30 minutes.
6. To change the core temperature, press C .

When the meat is at the set core temperature, a signal sounds. The oven turns off automatically.

7. Press any symbol to stop the signal.
8. Remove the core temperature sensor plug from the socket and remove the meat from the oven.
9. Press O to turn off the oven.

- ⚠ Warning!** The core temperature sensor is hot. There is a risk of burns. Be careful when you remove the tip and the plug of the core temperature sensor.

Using the telescopic runners

- i** Keep the installation instructions for the telescopic runners for future use.

With telescopic runners you can put in and remove wire shelves and trays easily.

- ⚠ Caution!** Do not clean the telescopic runners in the dishwasher. Do not lubricate the telescopic runners.

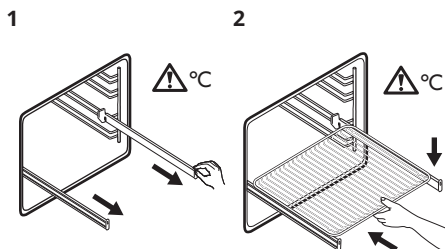

1 Pull out the right and left hand telescopic runners.

2 Put the wire shelf on the telescopic runners and carefully push them into the oven.

Make sure you push back the telescopic runners fully in the oven before you close the oven door.

- ⚠ Warning!** Refer to "Product description" chapter.

Additional functions

Favourites

You can save your favourite settings, such as duration, temperature or heating function. They are available in the menu: Favourites. You can save 20 programmes.

Saving a programme

1. Turn on the oven.
2. Set a heating function or an automatic programme.
3. Press **OK** again and again until the display shows: SAVE.
4. Press **OK** to confirm. The display shows the first free memory position.
5. Press **OK** to confirm.
6. Enter the name of the programme. The first letter flashes.
7. Press **∨** or **∧** to change the letter.
8. Press **OK**. The next letter flashes.
9. Do step 7 again as necessary.

10. Press and hold **OK** to save. You can overwrite a memory position. When the display shows the first free memory position, press **∨** or **∧** and press **OK** to overwrite an existing programme.

You can change the name of a programme in the menu: Edit Programme Name.

Activating the programme



1. Turn on the oven.
2. Select the menu: Favourites.
3. Press **OK** to confirm.
4. Select your favourite programme name.
5. Press **OK** to confirm.

You can press **☆** to go directly to menu: Favourites.

Using the Child Lock

When the Child Lock is on, the oven cannot be turned on accidentally.



 If the Pyrolysis function works, the door locks automatically. A message comes on in the display when you press any symbol.

1. Press  to turn on the display.
2. Press  and  at the same time until the display shows a message and a key symbol.



To turn off the Child Lock function repeat step 2.

Function Lock

This function prevents an accidental change of the heating function. You can turn it on only when the oven works.

1. Turn on the oven.
2. Set a heating function or setting.
3. Press  again and again until the display shows: Function Lock.
4. Press  to confirm.



 If the Pyrolysis function works, the door is locked and the symbol of a key comes on in the display.

To turn off the function, press . The display shows a message. Press  again and then  to confirm.

 When you turn off the oven, the function also turns off.

Set + Go

The function lets you set a heating function (or a programme) and use it later with one press of any symbol.

1. Turn on the oven.
2. Set a heating function.
3. Press  again and again until the display shows: Duration.
4. Set the time.
5. Press  again and again until the display shows: Set + Go.
6. Press  to confirm.



Press any symbol (except for ) to start the function: Set + Go. The set heating function starts.

When the heating function ends, a signal sounds.

-  • Function Lock is on when the heating function works.
- The menu: Basic Settings lets you turn the function: Set + Go on and off.

Automatic Switch-Off

For safety reasons the oven turns off automatically after some time, if a heating function works and you do not change any settings.

 (°C)	 (h)
30 - 115	12.5
120 - 195	8.5
200 - 245	5.5
250 - maximum	3

The Automatic Switch-off does not work with the functions: Light, Food Sensor, Duration, End Time.

Brightness of the display

There are two modes of display brightness:

- Night brightness - when the oven is turned off, the brightness of the display is lower between 10 PM and 6 AM.
- Day brightness:
 - when the oven is turned on.
 - if you touch a symbol during the night brightness (apart from ON / OFF), the display goes back to the day brightness mode for the next 10 seconds.

Cooling fan

When the oven operates, the cooling fan turns on automatically to keep the surfaces of the oven cool. If you turn off the oven, the cooling fan can continue to operate until the oven cools down.

Safety thermostat

Incorrect operation of the oven or defective components can cause dangerous overheating. To prevent this, the oven has a safety thermostat which interrupts the power supply. The oven turns on again automatically when the temperature drops.

Hints and tips

Cooking recommendations

Whenever preheating, remove the wire shelves and trays from the cavity to have the fastest performance.

The oven has five shelf positions. Count the shelf positions from the bottom of the cavity.

The oven has a special system which circulates the air and constantly recycles the steam. With this system you can cook in a steamy environment and keep the food soft inside and crusty outside. It decreases the cooking time and energy consumption to a minimum.

Moisture can condense in the oven or on the door glass panels during cooking. Always stand back from the oven when you open the oven door.

When the oven cools down, clean the cavity with a soft cloth.

Baking cakes

Do not open the oven door before 3/4 of the set cooking time is up.

If you use two baking trays at the same time, keep one empty level between them.

Cooking meat and fish

Use a deep pan for very fatty food to prevent the oven from stains that can be permanent.

Leave the meat for approximately 15 minutes before carving so that the juice does not seep out.

To prevent too much smoke in the oven during roasting, add some water into the deep pan. To prevent the smoke condensation, add water each time after it dries up.

Moist Fan Baking

For the best results follow suggestions listed in the table below.



Food	Accessories	Temperature (°C)	Shelf position	Time (min)
Sweet rolls, 12 pieces	baking tray or dripping pan	180	2	20 - 30
Rolls, 9 pieces	baking tray or dripping pan	180	2	30 - 40
Pizza, frozen, 0.35 kg	wire shelf	220	2	10 - 15

Food	Accessories	Temperature (°C)	Shelf position	Time (min)
Swiss roll	baking tray or dripping pan	170	2	25 - 35
Brownie	baking tray or dripping pan	175	3	25 - 30
Soufflè, 6 pieces	ceramic ramekins on wire shelf	200	3	25 - 30
Sponge flan base	flan base tin on wire shelf	180	2	15 - 25
Victoria Sandwich	baking dish on wire shelf	170	2	40 - 50
Poached fish, 0.3 kg	baking tray or dripping pan	180	3	20 - 25
Whole fish, 0.2 kg	baking tray or dripping pan	180	3	25 - 35
Fish fillet, 0.3 kg	pizza pan on wire shelf	180	3	25 - 30
Poached meat, 0.25 kg	baking tray or dripping pan	200	3	35 - 45
Shashlik, 0.5 kg	baking tray or dripping pan	200	3	25 - 30
Cookies, 16 pieces	baking tray or dripping pan	180	2	20 - 30
Macaroons, 20 pieces	baking tray or dripping pan	180	2	25 - 35
Muffins, 12 pieces	baking tray or dripping pan	170	2	30 - 40
Savory pastry, 16 pieces	baking tray or dripping pan	180	2	25 - 30
Short crust biscuits, 20 pieces	baking tray or dripping pan	150	2	25 - 35
Tartlets, 8 pieces	baking tray or dripping pan	170	2	20 - 30
Poached vegetables, 0.4 kg	baking tray or dripping pan	180	3	35 - 45

Food	Accessories	Temperature (°C)	Shelf position	Time (min)
Vegetarian omelette	pizza pan on wire shelf	200	3	25 - 30
Vegetables, mediterranean 0.7 kg	baking tray or dripping pan	180	4	25 - 30

Moist Fan Baking - recommended accessories

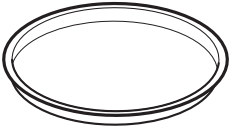
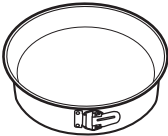
Use the dark and non-reflective tins and containers. They have better heat absorption than the light colour and reflective dishes.

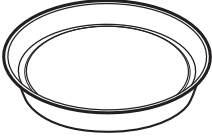
Accessories	Size	Picture
Pizza pan, dark, non-reflective	28 cm diameter	
Baking dish, dark, non-reflective	26 cm diameter	
Ramekins, ceramic	8 cm diameter, 5 cm height	
Flan base tin, dark, non-reflective	28 cm diameter	

Information for test institutes

Tests according to IEC 60350-1.

Food	Function	Accessories	Shelf position	Temperature (°C)	Time (min)	Comments
Small cake	Conventional Cooking	Baking tray	3	170	20 - 30	Put 20 small cakes per one baking tray.
Small cake	True Fan Cooking	Baking tray	3	150 - 160	20 - 35	Put 20 small cakes per one baking tray.
Small cake	True Fan Cooking	Baking tray	2 and 4	150 - 160	20 - 35	Put 20 small cakes per one baking tray.
Apple pie	Conventional Cooking	Wire shelf	2	180	70 - 90	Use 2 tins (20 cm diameter), diagonally shifted.
Apple pie	True Fan Cooking	Wire shelf	2	160	70 - 90	Use 2 tins (20 cm diameter), diagonally shifted.
Fatless-ponge cake	Conventional Cooking	Wire shelf	2	170	40 - 50	Use a cake mould (26 cm diameter). Preheat the oven for 10 minutes.
Fatless-ponge cake	True Fan Cooking	Wire shelf	2	160	40 - 50	Use a cake mould (26 cm diameter). Preheat the oven for 10 minutes.
Fatless-ponge cake	True Fan Cooking	Wire shelf	2 and 4	160	40 - 60	Use a cake mould (26 cm diameter). Diagonally shifted. Preheat the oven for 10 minutes.
Short bread	True Fan Cooking	Baking tray	3	140 - 150	20 - 40	-
Short bread	True Fan Cooking	Baking tray	2 and 4	140 - 150	25 - 45	-
Short bread	Conventional Cooking	Baking tray	3	140 - 150	25 - 45	-

Food	Function	Accessories	Shelf position	Temperature (°C)	Time (min)	Comments
Toast 4 - 6 pieces	Grill	Wire shelf	4	max.	2 - 3 minutes first side; 2 - 3 minutes second side	Preheat the oven for 3 minutes.
Beef burger 6 pieces, 0.6 kg	Grill	Wire shelf and dripping pan	4	max.	20 - 30	Put the wire shelf on the fourth level and the dripping pan on the third level of the oven. Turn the food half-way through the cooking time. Preheat the oven for 3 minutes.

Cooking tables

For additional cooking tables please refer to the Recipe Book which you can find on the website www.ikea.com. To find the proper

Recipe Book check the article number on the rating plate on the front frame of the oven cavity.

Care and cleaning



Warning! Refer to Safety chapters.

Notes on cleaning

Cleaning Agents

Clean the front of the oven with a soft cloth with warm water and a mild cleaning agent.

To clean metal surfaces, use a dedicated cleaning agent.

Clean stubborn stains with a special oven cleaner.

Everyday Use

Clean the oven cavity after each use. Fat accumulation or other food remains may cause fire. The risk is higher for the grill pan.

Moisture can condense in the oven or on the door glass panels. To decrease the condensation, operate the oven for 10

minutes before cooking. Dry the cavity with a soft cloth after each use.

Accessories

Clean all accessories after each use and let them dry. Use a soft cloth with warm water and a cleaning agent. Do not clean the accessories in the dishwasher.

Do not clean the non-stick accessories using aggressive agents, sharp-edged objects or in a dishwasher

Stainless steel or aluminium ovens

Clean the oven door with a damp cloth or sponge only. Dry it with a soft cloth.

Do not use steel wool, acids or abrasive materials as they can damage the oven surface. Clean the oven control panel with the same precautions.

Removing the shelf supports

To clean the oven, remove the shelf supports.

⚠ Caution! Be careful when you remove the shelf supports.

- 1. Pull the front of the shelf support away from the side wall.

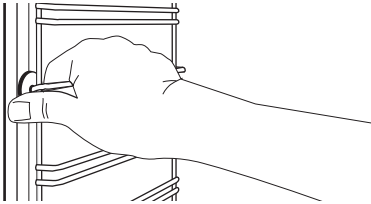

- 2. Pull the rear end of the shelf support away from the side wall and remove it.

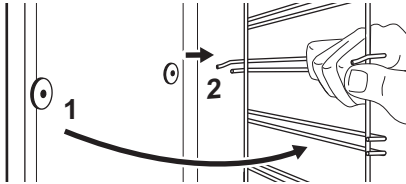

Install the removed accessories in the opposite sequence.

i The retaining pins on the telescopic runners must point to the front.

Cleaning

⚠ Caution! If there are other appliances installed in the same cabinet, do not use them at the same time as the function: Cleaning. It can cause damage to the appliance.

The cleaning cannot start:

- if the core temperature sensor is not removed.
- if the oven door are not closed.

- 1. Remove all accessories and removable shelf supports.

- 2. Clean the oven cavity with warm water and mild detergent. Clean the inner door glass with warm water and soft cloth.
- 3. Turn on the oven.
- 4. Enter the Menu and select the function: Cleaning. Press OK.
- 5. Set the duration of the cleaning:

Option	Description
Quick	For a light cleaning: 1 h.
Normal	For a standard cleaning: 1 h 30 min.
Intense	For a thorough cleaning: 2 h 30 min.

- 6. Press OK.
When the cleaning starts, the oven door is locked and the lamp does not work. To stop the cleaning before it is completed, turn off the oven.

⚠ Warning! After the function is completed, the oven is very hot. There is a risk of burns.

The door stays locked and some of the oven functions are not available after the cleaning is completed until temperature in the oven decreases.

Removing and installing door

The oven door has four glass panels. You can remove the oven door and the internal glass panels to clean them. Read the whole "Removing and installing door" instruction before you remove the glass panels.

i The oven door may close if you try to remove the glass panels before you remove the oven door.

⚠ Caution! Do not use the oven without the glass panels.

- 1. Open the door fully and hold both hinges.

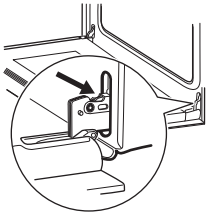

- 2. Lift and turn the levers fully on both hinges.

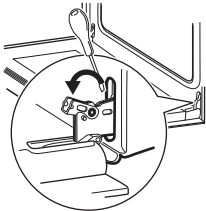

- 3. Close the oven door halfway to the first opening position. Then lift and pull forward and remove the door from its seat.

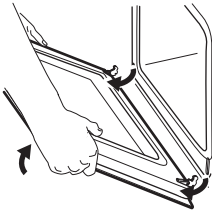

- 4. Put the door on a soft cloth on a stable surface.
- 5. Hold the door trim (B) on the top edge of the door at the two sides and push inwards to release the clip seal.

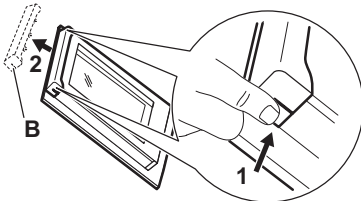

- 6. Pull the door trim to the front to remove it.
- 7. Hold the door glass panels by their top edge and carefully pull them out one by

one. Start from the top panel. Make sure the glass slides out of the supports completely.

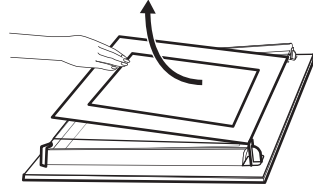

- 8. Clean the glass panels with water and soap. Dry the glass panels carefully. Do not clean the glass panels in the dishwasher.

When the cleaning is completed, install the glass panels, the door trim and the oven door, close the levers on the both hinges.

Make sure that you put the glass panels (A, B and C) back in the correct sequence. Check for the symbol / printing on the side of the glass panel, each of the glass panels looks different to make the disassembly and assembly easier.

The screen-printing zone must face the inner side of the door. Make sure that after the installation the surface of the glass panel frame on the screen-printing zones is not rough when you touch it.

When installed correctly the door trim clicks.

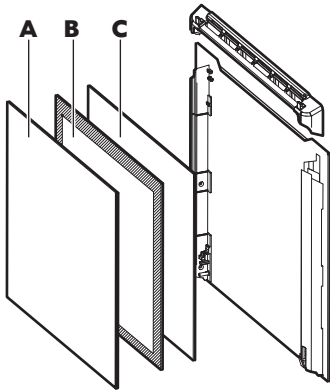

Make sure that you install the middle panel of glass in the seats correctly.

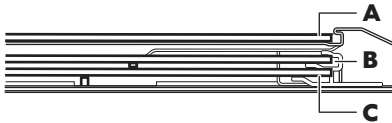

Replacing the lamp

Put a cloth on the bottom of the interior of the oven. It prevents damage to the lamp glass cover and the cavity.

Warning! Danger of electrocution! Disconnect the fuse before you replace the lamp. The lamp and the lamp glass cover can be hot.

Caution! Always hold the halogen lamp with a cloth to prevent grease residue from burning on the lamp.

1. Turn off the oven.
2. Remove the fuses from the fuse box or turn off the circuit breaker.
3. Turn the lamp glass cover counterclockwise to remove it.
4. Clean the glass cover.
5. Replace the oven light bulb with a 40 W, 230 V (50 Hz), 350 °C heat resistant oven light bulb (connection type: G9).
6. Install the glass cover.

Troubleshooting

Warning! Refer to Safety chapters.

What to do if...

Problem	Possible cause	Remedy
The oven does not heat up.	The oven is turned off.	Turn on the oven.
The oven does not heat up.	The clock is not set.	Set the clock.
The oven does not heat up.	The necessary settings are not set.	Make sure that the settings are correct.
The oven does not heat up.	The automatic switch-off is on.	Refer to "Automatic switch-off".
The oven does not heat up.	The Child Lock is on.	Refer to "Using the Child Lock".

Problem	Possible cause	Remedy
The oven does not heat up.	The door is not closed correctly.	Fully close the door.
The oven does not heat up.	The fuse is blown.	Make sure that the fuse is the cause of the malfunction. If the fuse is blown again and again, contact a qualified electrician.
The lamp does not operate.	The lamp is defective.	Replace the lamp.
The display shows F111.	The plug of the core temperature sensor is not correctly installed into the socket.	Put the plug of the core temperature sensor as far as possible into the socket.
The display shows an error code that is not in this table.	There is an electrical fault.	<ul style="list-style-type: none"> • Turn off the oven with the house fuse or the safety switch in the fuse box and turn it on again. • If the display shows the error code again, contact an Authorised Service Centre.
Steam and condensation settle on the food and in the cavity of the oven.	You left the dish in the oven for too long.	Do not leave the dishes in the oven for longer than 15 - 20 minutes after the cooking process ends.
The lamp is turned off.	The Moist Fan Baking function is turned on.	Normal behavior of the Moist Fan Baking function. Refer to "Daily Use" chapter, Heating Functions.
The door is locked.	There was a power cut.	Check the power supply.

Service data

If you cannot find a solution to the problem yourself, contact an Authorised Service Centre.

The necessary data for the service centre is on the rating plate. The rating plate is on the front frame of the oven cavity. Do not remove the rating plate from the oven cavity.

We recommend that you write the data here:	
Model (MOD.)
Product number (PNC)
Serial number (S.N.)

Technical data

Technical data

Dimensions (internal)	Width Height Depth	480 mm 361 mm 416 mm
Area of baking tray	1438 cm ²	
Top heating element	2300 W	
Bottom heating element	1000 W	
Grill	2300 W	
Ring	2400 W	
Total rating	3490 W	
Voltage	220 - 240 V	
Frequency	50 - 60 Hz	
Number of functions	18	

Energy efficiency

Product Information and Product Information Sheet*

Supplier's name	IKEA
Model identification	KULINARISK 904.430.55
Energy Efficiency Index	81.2
Energy efficiency class	A+
Energy consumption with a standard load, conventional mode	0.93 kWh/cycle
Energy consumption with a standard load, fan-forced mode	0.69 kWh/cycle
Number of cavities	1
Heat source	Electricity
Volume	72 l
Type of oven	Built-In Oven
Mass	36.1 kg

* For European Union according to EU Regulations 65/2014 and 66/2014.
 For Republic of Belarus according to STB 2478-2017, Appendix G; STB 2477-2017, Annexes A and B.
 For Ukraine according to 568/32020.

Energy efficiency class is not applicable for Russia.

EN 60350-1 - Household electric cooking appliances - Part 1: Ranges, ovens, steam ovens and grills - Methods for measuring performance.

Energy saving



The oven contains features which help you save energy during everyday cooking.

General hints

Make sure that the oven door is closed properly when the oven operates. Do not open the door too often during cooking. Keep the door gasket clean and make sure it is well fixed in its position.

Use metal dishes to improve energy saving.

When possible, do not preheat the oven before you put the food inside.

When the cooking duration is longer than 30 minutes, reduce the oven temperature to minimum 3 - 10 minutes before the end of the cooking time, depending on the duration of the cooking. The residual heat inside the oven will continue to cook.

Use the residual heat to warm up other dishes.

Keep breaks between baking as short as possible when you prepare few dishes at one time.

Cooking with fan

When possible, use the cooking functions with fan to save energy.

Residual heat

If a programme with the Duration or End Time selection is activated and the cooking time is longer than 30 minutes, the heating elements automatically deactivate earlier in some oven functions.

The fan and lamp continue to operate.

Keep food warm

Choose the lowest possible temperature setting to use residual heat and keep a meal warm. The residual heat indicator or temperature appears on the display.

Cooking with the lamp off

Turn off the lamp during cooking. Turn it on only when you need it.

Moist Fan Baking

Function designed to save energy during cooking.

When you use this function the lamp automatically turns off after 30 seconds. You may turn on the lamp again but this action will reduce the expected energy savings.

Environmental concerns

Recycle materials with the symbol . Put the packaging in relevant containers to recycle it. Help protect the environment and

human health by recycling waste of electrical and electronic appliances. Do not dispose of appliances marked with the symbol  with

the household waste. Return the product to your local recycling facility or contact your municipal office.

IKEA guarantee

How long is the IKEA guarantee valid?

This guarantee is valid for five (5) years - two (2) years if the appliance is named LAGAN or TILLREDA - from the original date of purchase of your appliance at IKEA or from the installation date with maximum limit of three months from the purchase date. The original sales receipt, is required as proof of purchase. If service work is carried out under guarantee, this will not extend the guarantee period for the appliance. Once a warranted product has been replaced, the replaced product warranty will be valid for the balance period from date of original purchase invoice.

Who will execute the service?

IKEA service provider will provide the service through its own service operations or authorized service partner network.

What does this guarantee cover?

- The guarantee covers faults of the appliance, which have been caused by faulty construction or material faults from the date of purchase from IKEA or from the installation date with maximum limit of three months from the purchase date.
- This guarantee applies to domestic use only.
- The exceptions are specified under the headline "What is not covered under this guarantee?" Within the guarantee period.
- The costs to remedy the fault e.g. repairs, parts, labour and travel will be covered, provided that the appliance is accessible for repair without special expenditure. On these conditions the respective local regulations are applicable.
- Replaced parts become the property of IKEA.
- In case of non-repairable product, the retail value of the replacement will not

exceed the purchase price that was paid by the customer

What will IKEA do to correct the problem?

- IKEA appointed Service Provider will examine the product and decide, at its sole discretion, if it is covered under this guarantee. If considered covered, IKEA Service Provider or its authorized service partner through its own service operations, will then, at its sole discretion, either repair the defective product or replace it with the same or a comparable product.

What is not covered under this guarantee?

- Normal wear and tear.
- Deliberate or negligent damage, damage caused by failure to observe operating instructions, incorrect installation or by connection to the wrong voltage, damage caused by chemical or electro-chemical reaction, rust, corrosion or water damage including but not limited to damage caused by excessive lime in the water supply, damage caused by abnormal environmental conditions.
- Consumable parts including batteries and lamps.
- Non-functional and decorative parts which do not affect normal use of the appliance, including any scratches and possible colour differences.
- Accidental damage caused by foreign objects or substances and cleaning or unblocking of filters, drainage systems or soap drawers.
- Damage to the following parts: ceramic glass, accessories, crockery and cutlery baskets, feed and drainage pipes, seals, lamps and lamp covers, screens, knobs, casings and parts of casings. Unless such

damages can be proved to have been caused by production faults.

- Cases where no fault could be found during a technician's visit.
- Repairs not carried out by our appointed service providers and/or an authorized service contractual partner or where non-original parts have been used.
- Repairs caused by installation which is faulty or not according to specification.
- The use of the appliance in a non-domestic environment i.e. professional use.
- Damage resulting from power outage, power surges or dips, fluctuating voltage or improper voltage All workout parts are not covered by the guarantee e.g.: filters and cleanliness.
- Transportation damages. If a customer transports the product to his home or another address, IKEA is not liable for any damage that may occur during transport. However, if IKEA delivers the product to the customer's delivery address, then damage to the product that occurs during this delivery will be covered by IKEA.
- Cost for carrying out the initial installation of the IKEA appliance. However, if an IKEA service provider or its authorized service partner repairs or replaces the appliance under the terms of this guarantee, the service provider or its authorized service partner will re-install the repaired appliance or install the replacement, if necessary.
- All plumbing and electrical installation, are not the responsibility of IKEA, and customer must complete these work before the execution work.

How country law applies

The IKEA guarantee gives you specific legal rights, which covers or exceed local demands. However these conditions do not limit in any way consumer rights described in the local legislation.

Area of validity

This warranty is valid only in the country where the product has been purchased; the

services will be provided in the framework of the guarantee conditions.

An obligation to carry out services in the framework of the guarantee exists only if the appliance complies and is installed in accordance with:

- the technical specifications of the country in which the guarantee claim is made;
- the Assembly Instructions and User Manual Safety Information;

The dedicated After Sales Service for IKEA appliances:

Please don't hesitate to contact IKEA appointed After Sales Service Provider to:



- make a service request under this guarantee;
- ask for clarifications on installation of the IKEA appliance in the dedicated IKEA kitchen furniture;
- ask for clarification on functions of IKEA appliances.

To ensure that we provide you with the best assistance, please read carefully the Assembly Instructions and/or the User Manual before contacting us.

How to reach us if you need our service



Please refer to the last page of this manual for the full list of IKEA appointed contacts and relative national phone numbers.

-  In order to provide you with a quicker service, we recommend that you use the specific phone numbers listed at the end of this manual. Always refer to the numbers listed in the booklet of the specific appliance you need an assistance for. Before calling us, assure that you have to hand the IKEA article number (8 digit code) and the Serial Number (8 digit code that can be found on the rating plate) for the appliance of which you need our assistance.
-  **SAVE THE SALES RECEIPT!** It is your proof of purchase and required for the guarantee to apply. The sales receipt also reports the IKEA name and article number (8 digit code) for each of the appliances you have purchased.



UNITED ARAB EMIRATES & OMAN

Toll free: 8 004 532 : رقم مجاني
Web: www.IKEA.com : موقع الإنترنت

QATAR

Toll free: 8 004 532 : رقم مجاني
Web: www.IKEA.qa : موقع الإنترنت
e-mail: Ikea_qatar@alfuttaim.com : البريد الإلكتروني

EGYPT

Hotline: 16576 : الخط الساخن
Web: www.IKEA.eg : موقع الإنترنت
e-mail: IkeaCairo.customerservice@alfuttaim.com : البريد الإلكتروني

STATE OF KUWAIT

Contact centre: +965 18 40 40 8 : مركز الاتصال
Web: www.IKEA.com.kw : موقع الإنترنت
e-mail: info@IKEA.com.kw : البريد الإلكتروني

JORDAN

Contact centre: +962 6 400 1000 : مركز الاتصال
Web: www.IKEA.jo : موقع الإنترنت

KINGDOM OF SAUDI ARABIA

Contact centre: 92000-4532 : مركز الاتصال
Our phone lines are open: خطوط الهاتف لدينا مفتوحة:
Saturday - Thursday 09:00 AM - 10:00 PM السبت - الخميس
Friday 2:00 PM - 10:00 PM يوم الجمعة

BAHRAIN

Contact centre: 80001120 : مركز الاتصال
Our telephone lines are open all day 09:00 AM - 10:00 PM خطوط الهاتف لدينا مفتوحة طوال اليوم

867368263-A-122021

