

GB

FR

ES

SAMTID

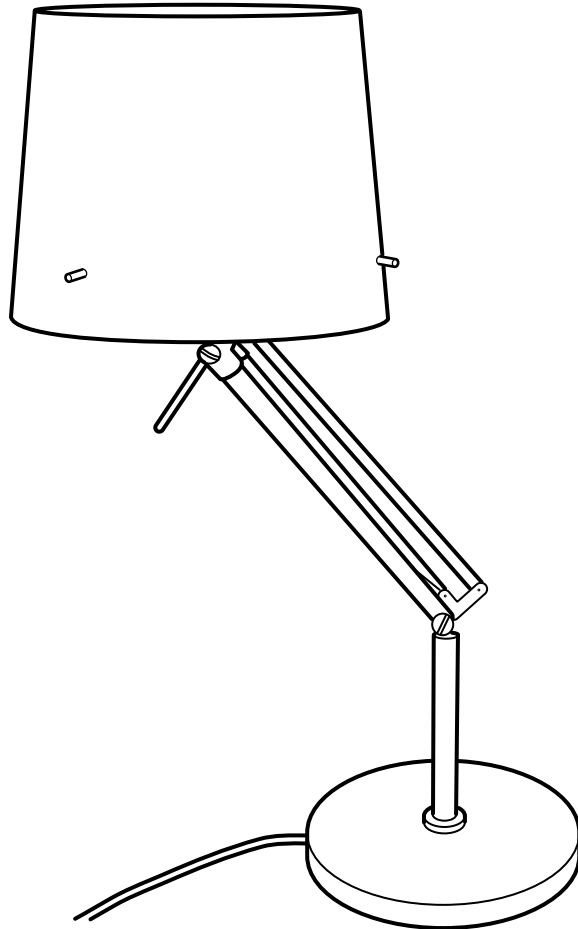

Design and Quality
IKEA of Sweden



ENGLISH

IMPORTANT SAFETY INSTRUCTIONS

This product has a polarized plug (one blade is wider than the other) as a feature to reduce the risk of electric shock. This plug will fit in a polarized outlet only one way. If the plug does not fit fully in the outlet, reverse the plug. If it still does not fit, contact a qualified electrician. Never use with an extension cord unless plug can

be fully inserted. Do not attempt to defeat the safety purpose of the polarized attachment plug. Do not alter the plug.

CAUTION: TO PREVENT ELECTRICAL SHOCK, MATCH WIDE BLADE OF PLUG TO WIDE SLOT, FULLY INSERT.

ENGLISH

WARNING

Deviation from the assembly instructions may result in a risk of fire or electric shock.

FRANÇAIS

CONSIGNES DE SÉCURITÉ IMPORTANTES

Ce produit est muni d'une fiche polarisée (une lame est plus large que l'autre). Pour des raisons de sécurité, cette fiche ne s'insère que d'une seule façon dans la prise polarisée. Si la fiche ne s'insère pas complètement dans la prise, inverser la fiche. Si vous n'arrivez toujours pas à insérer la fiche dans la prise, consultez un électricien qualifié. Ne jamais utiliser un fil de rallonge à moins que la fiche ne

puisse être insérée complètement. Ne jamais tenter de déjouer le dispositif de sécurité de la fiche. Ne jamais modifier la fiche.

AVERTISSEMENT : POUR EVITER TOUT RISQUE DE CHOC ELECTRIQUE, INTRODUIRE LA FICHE LARGE DANS LA FENTE LARGE DE LA PRISE DE COURANT EN S'ASSURANT QU'ELLE S'INSERE COMPLETEMENT.

FRANÇAIS

ATTENTION

Tout écart par rapport aux instructions d'assemblage peut entraîner un risque d'incendie ou de choc électrique.



ESPAÑOL

INSTRUCCIONES IMPORTANTES DE SEGURIDAD

Este producto tiene un enchufe polarizado (una patilla es más ancha que la otra) para reducir el riesgo de cables. Este enchufe sólo se podrá enchufar de una forma. Si el enchufe no se puede introducir completamente en la toma, gíralo. Si sigue sin poderse enchufar, contactar con un electricista cualificado. Nunca se debe usar un alargador si el enchufe no se

puede enchufar de forma correcta. Nunca se debe alterar el dispositivo de seguridad del alargador polarizado. No manipular el enchufe.

ADVERTENCIA: PARA EVITAR CABLES, LA PATILLA ANCHA DEL ENCHUFE DEBE COINCIDIR CON LA RANURA ANCHA E INTRODUCIRSE COMPLETAMENTE.

ESPAÑOL

ADVERTENCIA

No seguir las instrucciones de montaje puede resultar en incendio o descarga eléctrica.

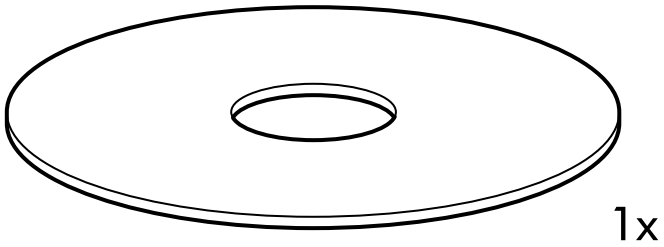
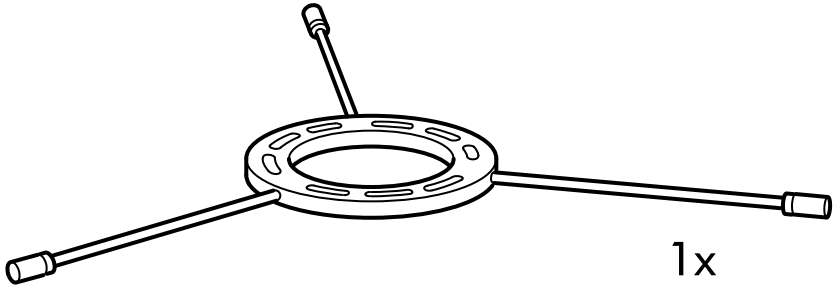
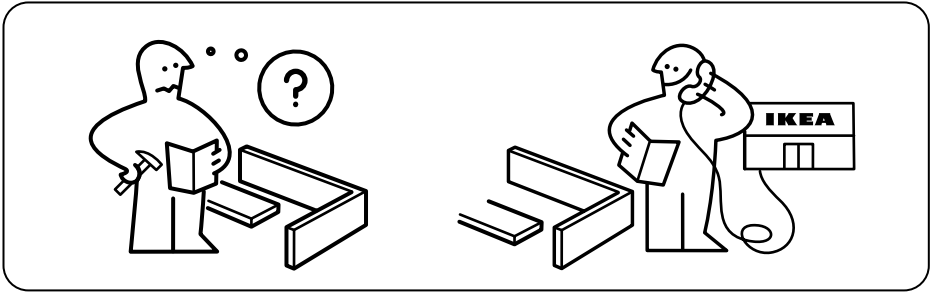

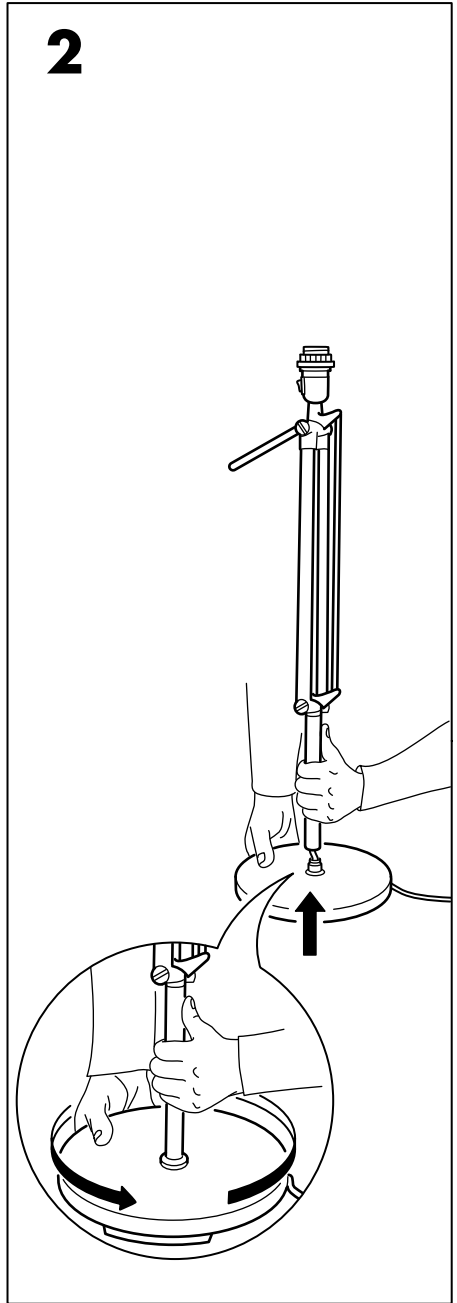
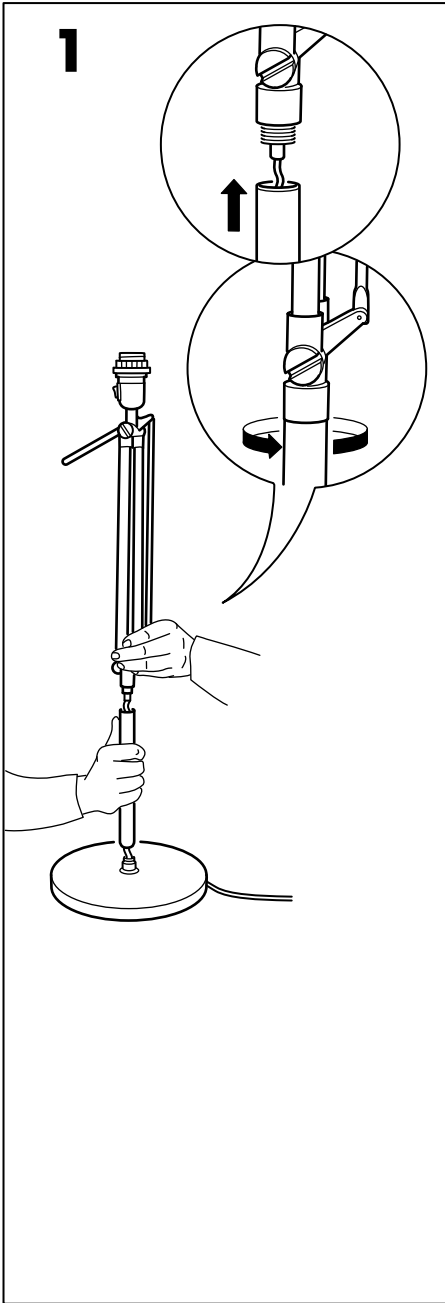

3

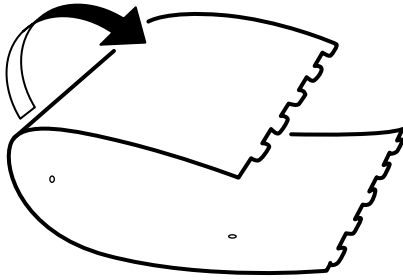

4

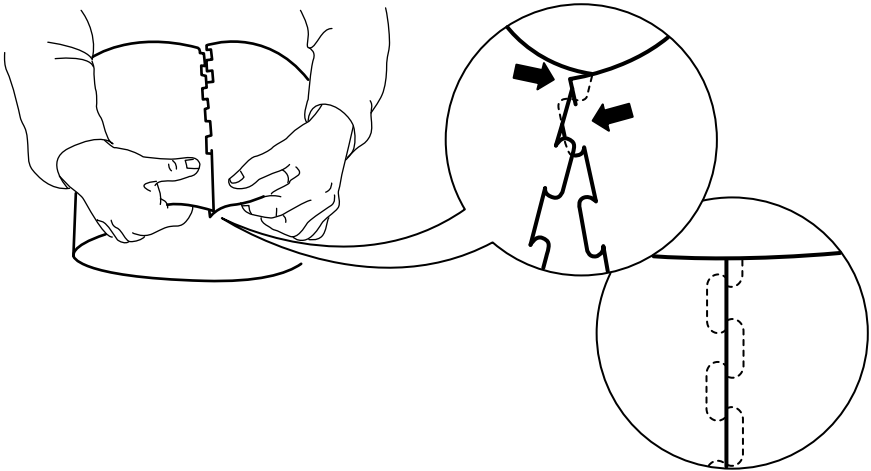

5

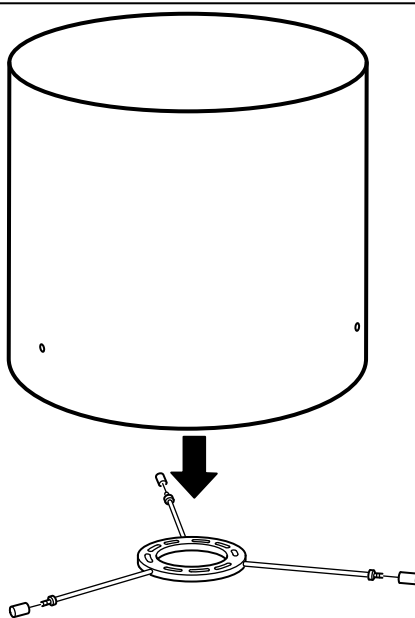
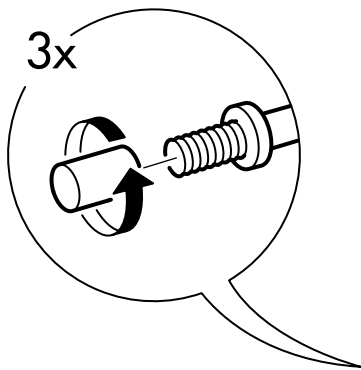

6

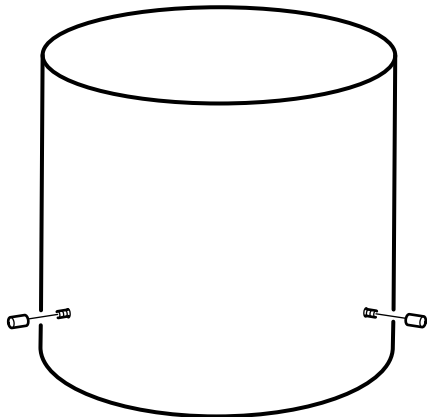
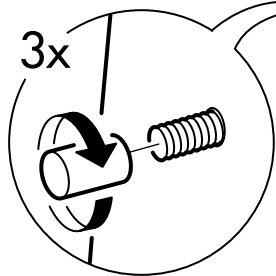

7

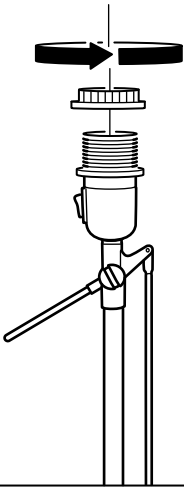

8

